

Owner's manual SEAT ARONA

ARONA

Vehicle identification data

Model:
Vehicle Registration:
Vehicle identification number:
Date of vehicle registration or vehicle delivery:
SEAT Official Service:
Service advisor:
Telephone:

Confirmation of receipt of documentation and vehicle keys

The following items were delivered with the vehicle:	YES	NO
On-board documentation	<input type="checkbox"/>	<input type="checkbox"/>
First key	<input type="checkbox"/>	<input type="checkbox"/>
Second key	<input type="checkbox"/>	<input type="checkbox"/>
Correct working order of all keys was checked	<input type="checkbox"/>	<input type="checkbox"/>
Location:		
Date:		
Signature of owner:		

Thank you for your confidence

With your new SEAT, you will be able to enjoy a vehicle with state-of-the-art technology and top quality features.

We recommend reading this Instruction Manual carefully to learn more about your vehicle so you can enjoy all its benefits in your daily driving.

Information about handling is complemented with instructions regarding the operation and maintenance of the vehicle in order to ensure its safety and maintain its value. Moreover, we want to give you valuable advice and tips for driving your vehicle in an efficient and environmentally friendly manner.

We wish you safe and enjoyable motoring.

SEAT, S.A.

WARNING

Read and always observe safety information concerning the front passenger airbag
»» page 54, *Fitting and using child seats.*

Table of Contents

About this instruction manual	4	Steering wheel	82	ACC - Adaptive Cruise Control	143
General views of the vehicle	6	Multifunction steering wheel	82	Emergency brake assistance system (Front Assist)	148
Front exterior view	6	Seats and headrests	84	Lane Assist system	151
Rear exterior view	7	Front seats	84	Travel Assist	153
Interior view	8	Rear seats	84	Lane departure warning (Side Assist)	156
Overview (left hand drive)	9	Headrest	85	Parking and manoeuvring	159
Overview (right hand drive)	10	Lights	88	Park the vehicle	159
Driver information	11	Vehicle lighting	88	Parking brake	160
Control lamps	11	Interior lights	94	General information on parking systems	160
Instrument cluster	13	Visibility	96	Park Distance Control Plus (Park Pilot)	162
Drowsiness monitor	24	Windscreen wiper and rear window wiper systems	96	Rear park assist	166
Road signs detection system	27	Mirrors	98	Park assist system (Park Assist)	167
Instrument cluster operation	30	Sun protection	101	Reverse Assist (Rear View Camera)	174
Infotainment system operation and displays	32	Air conditioning	102	Rear Cross Traffic Alert)	176
Safety	37	Heating, ventilation and cooling	102	Practical equipment	178
Safe driving	37	Driving	109	Storage compartment	178
Correct sitting position of vehicle occupants	38	Driving indications	109	Power sockets	180
Seat belts	40	Starting and stopping the engine.	113	Data transmissions	182
Airbag system	46	Start-Stop system	118	Over-the-air update	182
Transporting children safely	52	Manual gearbox	120	SEAT CONNECT	184
In case of emergency	61	DSG automatic transmission	121	Privacy mode	189
Opening and closing	66	Driving on slopes	127	WLAN access point	190
Set of vehicle keys	66	Steering	128	Full Link	191
Keyless Access system	68	SEAT Drive Profiles	129	Wired and wireless connections	194
Central locking	70	Braking system	130	Infotainment system	195
Anti-theft alarm	74	Brake assist systems	132	First steps	195
Doors	75	Assistant systems	135	Overview and controls	198
Rear lid	78	General notes	135	General instructions for use	200
Window controls	79	Drive assist sensors and cameras	136	Voice control	205
		Cruise control system	139	Radio mode	207
		Speed limiter	141	Media Mode	211
		Eco-efficient driving assistance	142	Navigation	214
				Telephone interface	221

Storing objects	227	Maintenance	302
Positioning the luggage and cargo	227	Service	302
Luggage compartment	228	Additional service offers	304
Luggage compartment equipment	230	Vehicle upkeep and cleaning	305
Roof carrier	230	Accessories, spare parts and repair work	310
Trailer mode	232	User information	312
Towing device	242	Warranty	312
Fuel and exhaust gas cleaning	246	Information stored by the control units	312
Refuelling	246	Vehicle antennas	312
Fuel types	247	Fluids in the air conditioning system	313
Engine management and emissions control system	248	Information on the EU chemicals regulation REACH	314
Miscellaneous situations	251	Materials and recycling information	314
Vehicle tool kit	251	Return and scrapping of end-of-life vehicles	316
Changing the windscreen wiper blades	251	Declaration of conformity	316
Jump start	253	Radioelectrical equipment	317
Towing the vehicle	255	Technical data	321
Fuses	259	Indications about the technical data	321
Changing bulbs	262	Engine specifications	323
Checking and refilling levels	267	Dimensions	324
Engine compartment	267	Index	327
Fluids and consumables	270		
Cooling system	270		
Brake fluid	273		
Windscreen washer reservoir	274		
Engine oil	275		
12-volt battery	279		
Energy management	282		
Wheels and tyres	285		
Important information about wheels and tyres	285		
Changing a wheel	291		
Tyre pressure monitor system	297		
Tyre repair	298		

About this instruction manual

This instruction manual is valid for all variants and versions of your SEAT model. It describes all equipment and models without specifying whether their features are optional equipment of model variants. As a result, equipment not fitted to your vehicle or only available in certain countries may be described. Find out about your vehicle's equipment in the documentation supplied with it and please contact your SEAT Official Service if you require more detailed information.

All information provided in this instruction manual corresponds to the information available at the time of going to press. As the vehicle is under continuous development, it may have differences to the data included in this manual. For this reason, no claims can be made in the event of mismatching data, illustrations and descriptions.

Ensure that the on-board documentation is kept in the vehicle at all times if you sell it or lend it to third parties. In addition, SEAT recommends resetting the infotainment system to factory settings to delete all personal data.

Some details on the **drawings** may be different to your vehicle and they should be interpreted as a standard representation.

The **direction indicators** (left, right, forwards, backwards) in this manual refer to the direction of travel of the vehicle unless otherwise stated.

This instruction manual has been written for **left-hand drive vehicles**. In right-hand drive vehicles, the arrangement of the controls differs partly from that shown in the illustrations or described in the texts.

Technical modifications to the vehicle or safety-critical issues that have arisen since the time of going to press will be included in a supplement to the on-board documentation.

® **Trademarks** are marked with ®. The absence of this symbol does not guarantee that the term is not a trademark.

You can access the information in this manual using:

- Thematic table of contents that follows the manual's general chapter structure.
- Visual table of contents that uses graphics to indicate the pages containing "essential" information, which is detailed in the corresponding chapters.
- Alphabetical index with many terms and synonyms to help you find information.

! NOTICE

Texts after this symbol indicate possible damage to the vehicle.

🌿 For the sake of the environment

Texts after this symbol contain information on environmental protection.

i Note

Texts after this symbol contain additional information.

⚠ WARNING

Texts after this symbol contain information about safety and warn you about possible accident or injury risks.

Digital instruction manual

The digital version of the manual can be found on SEAT's official website:



- scan the QR code.
- **OR** enter the following website address in your browser:

<https://www.seat.com/owners/about-my-car/manuals.html>

and select your vehicle.

Related videos

The operation of some of the vehicle's features can be shown as an instruction video:



- scan the QR code.
- **OR** enter the following website address in your browser:

<https://www.seat.com/owners/about-my-car/manuals.html>

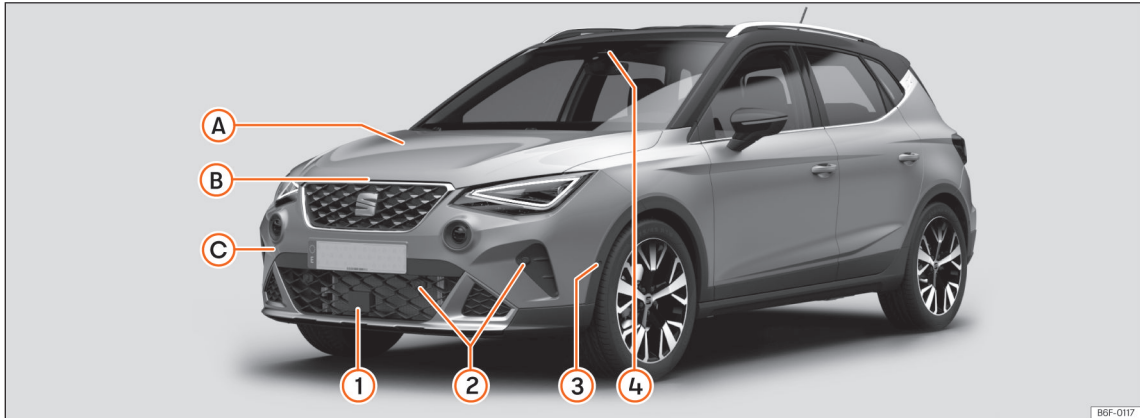
choose your vehicle and then the "Multimedia" section.

Note

Video instructions are only available in certain languages.

General views of the vehicle

Front exterior view



B6F-0117

Driving assistance sensors >>> page 135

- ① Front radar
- ② Park distance control sensors
- ③ Park assist sensor
- ④ Front multifunction camera

Ⓐ Levels control

Oil >>> page 275

Brake fluid >>> page 273

Battery >>> page 279

Ⓑ Bonnet

Unlocking lever >>> page 269

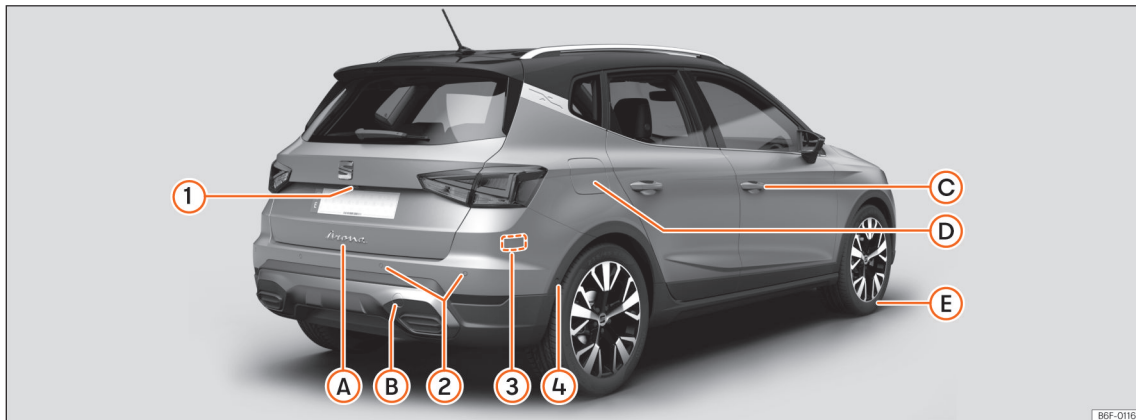
Open/close >>> page 269

Ⓒ Towing the vehicle

Tow start >>> page 256

Towline anchorage >>> page 257

Rear exterior view



B6F-0116

Driving assistance sensors >>> page 135

- ① Rear view camera
- ② Park distance control sensors
- ③ Rear radars
- ④ Park assist sensor

A Rear lid

- Opening from outside >>> page 79
- Emergency opening >>> page 79

B Towing the vehicle

- Tow-start >>> page 256
- Towline anchorage >>> page 258

C Opening and closing

- Doors >>> page 75
- Central locking >>> page 70
- Emergency lock >>> page 77

D Fuel tank

- Fuel capacity >>> page 321
- Open/Close cap >>> page 246

E Action in the event of a puncture

- Tyre mobility system >>> page 298
- Wheel change >>> page 291

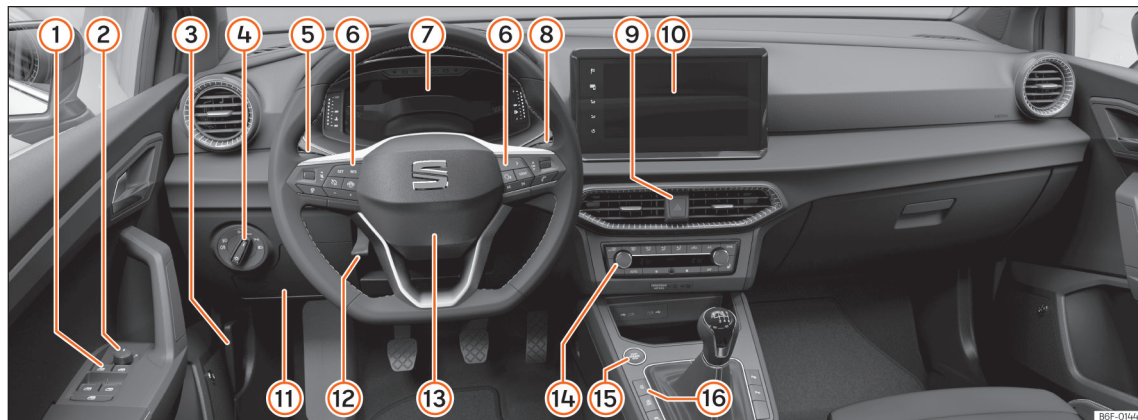
Interior view



- ① Isofix anchors >>> page 55
- ② Headrest adjustment >>> page 85
- ③ Seat belts >>> page 41
- ④ Interior mirror >>> page 99
- ⑤ Seat adjustment >>> page 84
- ⑥ DSG automatic transmission
>>> page 121 / Manual gearbox
>>> page 120

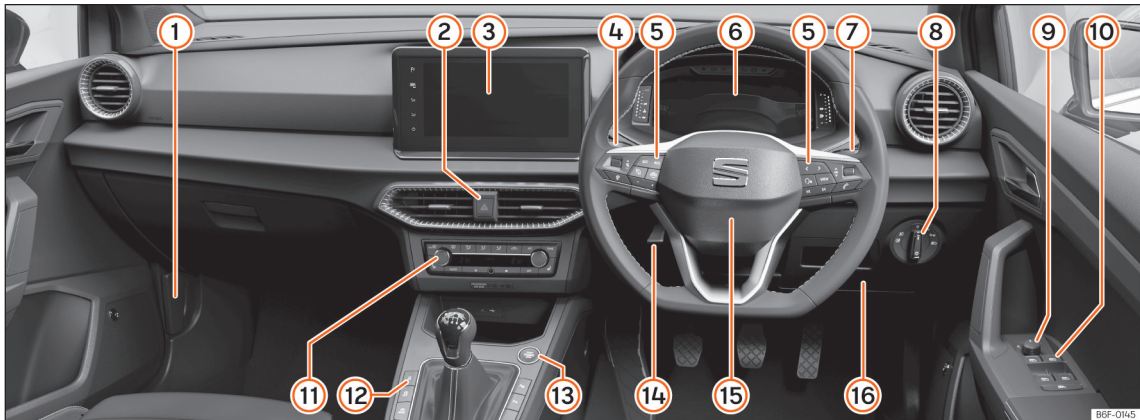
- ⑦ Connectivity Box / Wireless Charger
>>> page 225
- ⑧ Emergency start >>> page 118
- ⑨ Glove compartment >>> page 178
- ⑩ Front passenger airbag >>> page 49
- ⑪ Disconnecting the front passenger airbag
>>> page 50

Overview (left hand drive)



- | | | |
|---|---|--|
| ① Power windows >>> page 79 | ⑧ Wipers and rear window wiper >>> page 96 | ⑮ Start button (depending on version) >>> page 114 |
| ② Exterior mirror adjustment >>> page 100 | ⑨ Hazard warning lights >>> page 61 | ⑯ Central locking >>> page 70 |
| ③ Open bonnet lever >>> page 269 | ⑩ Infotainment system >>> page 32, >>> page 195 | |
| ④ Lighting control >>> page 88 | ⑪ Fuses >>> page 259 | |
| ⑤ Turn signal and main beam lever >>> page 90 | ⑫ Steering wheel adjustment >>> page 83 | |
| ⑥ Multifunction steering wheel control panels >>> page 82 | ⑬ Steering wheel with driver's airbag >>> page 49 / Gear shift paddles for the Tiptronic >>> page 123 | |
| ⑦ SEAT Digital Cockpit >>> page 16 | ⑭ Air conditioning >>> page 104 | |
| Control lamps >>> page 11 | | |

Overview (right hand drive)



- ① Open bonnet lever >>> page 269
- ② Hazard warning lights >>> page 61
- ③ Infotainment system >>> page 32, >>> page 195
- ④ Turn signal and main beam lever >>> page 90
- ⑤ Multifunction steering wheel control panels >>> page 82
- ⑥ SEAT Digital Cockpit >>> page 16
Control lamps >>> page 11
- ⑦ Wipers and rear window wiper >>> page 96
- ⑧ Lighting control >>> page 88
- ⑨ Exterior mirror adjustment >>> page 100
- ⑩ Power windows >>> page 79
- ⑪ Air conditioning >>> page 104
- ⑫ Central locking >>> page 70
- ⑬ Start button (depending on version) >>> page 114
- ⑭ Steering wheel adjustment >>> page 83
- ⑮ Steering wheel with driver's airbag >>> page 49 / Gear shift paddles for the Tiptronic >>> page 123
- ⑯ Fuses >>> page 259

Driver information


Control lamps

Control and warning lamps

The warning and control lights can be lit individually or in combination and serve as a warning, to indicate the presence of an anomaly or to warn of the activation of certain functions. Some turn on when the ignition is switched on and have to be switched off after a certain period of time.

Depending on the model, additional text messages may be viewed on the instrument panel display. These may be purely informative or they may be advising of the need for action.

Warning with priority 1:

- The red central warning lamp lights up or flashes, possibly accompanied by additional audio warnings or symbols.  **Stop driving!** **Danger!** Check the faulty function. Seek specialist assistance as soon as possible.

Warning with priority 2:

- The yellow central warning lamp lights up or flashes, possibly accompanied by additional audio warnings or symbols. Operating faults or the lack of operating fluids can cause damage to the vehicle or a fault. Check the faulty function as soon as possible and, if necessary, contact a specialist workshop immediately.

SEAT recommends visiting an Official SEAT Service.

Lamps with other colours:

- Green, blue, white and grey: Information on other systems.

Depending upon the equipment fitted in the vehicle, instead of a warning lamp, sometimes a symbol may be displayed on the instrument panel.

WARNING

If the warning lamps and messages are ignored, faults may occur in the vehicle, it may stall in traffic, or accidents and serious injuries may occur.

















- Never ignore warning lamps or text messages.
- Stop the vehicle as soon as possible in a safe place.

Note

If there are several warnings, the corresponding symbols will light up for a few seconds and remain lit until the cause is eliminated.

If when switching on the ignition warnings are shown about existing faults, it might not be possible to change the settings or show the information as described. If the fault continues, consult a specialised workshop.

SEAT recommends visiting an Official SEAT Service.













Symbol	Meaning
	 Stop driving! Central warning lamp >>> page 22
	Fasten your seat belt >>> page 41
	Parking brake applied >>> page 160
	 Stop driving! Fault in the brake system >>> page 131
	 Stop driving Brake fluid level low >>> page 274
	Take control of the vehicle and be ready to brake! >>> page 143
	 Stop driving Fault in the motor coolant fluid system >>> page 19
	Engine oil pressure >>> page 278
	 Stop driving! Steering anomaly >>> page 128
	 Stop driving! Alternator fault >>> page 282





Driver information

Symbol	Meaning
	Collision warning >>> page 149
	Take control of the steering immediately >>> page 155
	Central warning lamp >>> page 22
	Fault in the airbag system or the seat belt tensioners >>> page 48
OFF	Front passenger airbag off >>> page 48
ON	Front passenger airbag on >>> page 48
	Lights up: fault in the electronic stability control (ESC) >>> page 134
	Flashing: Electronic stability control (ESC) or Traction Control (TCS) regulating >>> page 134
	TCS switched off manually or ESC in Sport mode >>> page 133
	ABS fault >>> page 133
	Travel Assist not available >>> page 155
	Fault in the vehicle's lighting >>> page 88
	Fault in the emissions control system >>> page 249

Symbol	Meaning
	Particulate filter clogged >>> page 250
EPC	Petrol engine management fault >>> page 250
	Rear fog light on >>> page 88
	Fuel tank almost empty >>> page 18
	Engine oil level >>> page 279
	Steering anomaly >>> page 128
	iStop driving!
	Low tyre pressure >>> page 298
	Collision warning deactivated >>> page 151
	Cruise control fault (GRA) >>> page 140
LIM	Speed limiter not available >>> page 142
	Gearbox fault >>> page 126, >>> page 126
	Adaptive cruise control (ACC) not available >>> page 148
	Lane Assist not available >>> page 153

Symbol	Meaning
	Lane Assist (lane keeping system) regulating >>> page 152
	Lane Assist deactivated >>> page 152
	Drowsiness monitor limited or unavailable >>> page 26
	Side Assist (lane change assistance system) not available >>> page 138
	Traffic sign recognition limited or not available >>> page 30
	Rear Cross Traffic Alert not available >>> page 138
	Battery / 12V power supply >>> page 282
	Turn signals >>> page 88
	Trailer turn signals >>> page 88
	Cruise control (GRA) >>> page 139
	Speed limiter active >>> page 141
	Lane Assist (lane keeping system) active. >>> page 152
	Press the brake pedal >>> page 126
	Travel Assist active >>> page 154

Symbol	Meaning
	Adaptive Cruise Control (ACC) regulating, no vehicle detected ahead »» page 145
	Adaptive Cruise Control (ACC) regulating, vehicle detected ahead »» page 145
	Main beam on or flasher on »» page 88
	Main beam assist active »» page 88
	The speed limiter is not active »» page 141
	Start-Stop system activated »» page 118
	Start-Stop system unavailable »» page 118
	Travel Assist active, adaptive cruise control (ACC) active and adaptive lane guidance function passive. »» page 154
	Exterior temperature below +4 °C (+39 °F) »» page 20
	Main beam assist on »» page 91
	Take control of the steering »» page 155
	Speed warning system partially deactivated »» page 30

Symbol	Meaning
	Distance warning »» page 149
	Reference to information in the on-board documentation »» page 23
	Remove foot from accelerator »» page 142
	Service intervals display »» page 23

Instrument cluster

Introduction

After switching the engine on with a 12-volt battery that is heavily discharged or newly replaced, some system settings (such as the time, the date, the personalised comfort settings and the programming) might be altered or deleted. Check and correct these settings once the battery is sufficiently charged.

WARNING

Any distraction may lead to an accident, with the risk of injury.

- Do not operate the instrument cluster controls when driving.
- To reduce the risk of accident and injury, only make adjustments to the instructions on the instrument cluster display and to the instructions on the Infotainment system display when the vehicle is stationary.

Basic version digital instrument cluster

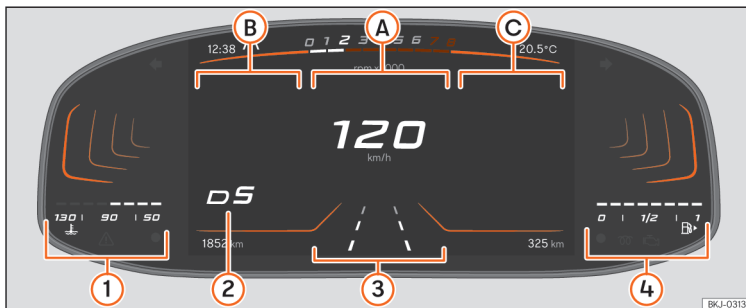


Fig. 1 Basic version digital instrument cluster: Main view.

Upper zone: Time, selected drive profile, rev counter, outside temperature. **Lower zone:** total km (miles) or speed set with the cruise control or ACC, range.

- A Main display:** speed in digital format and road signs.
- B Secondary indications:** driving data [average speed and fuel consumption, distance travelled, etc.]
- C Secondary indications:** radio, media, phone, navigation indications.
- 1** Engine coolant temperature indicator »» page 18.
- 2** Gear engaged and gear or selector lever position recommendation.
- 3** Selected driving assistant.

- 4** Fuel gauge »» page 17.

The Basic version digital instrument cluster is a digital instrument cluster with a high resolution colour TFT display.

Other content can be displayed by selecting different views, e.g. **Rev counter**, and different displays in the main display area and in the secondary display areas.

Instrument cluster operation

The digital instrument cluster can only be controlled from the buttons on the multi-function steering wheel. The functions of the buttons on the multifunction steering wheel depend on the equipment.

As long as a priority 1 warning is active, it will not be possible to access any menu »» page 22. Some warnings can be confirmed and hidden with the button **OK** of the multifunction steering wheel.

Instrument cluster views

To switch between the different views press the **VIEW** button on the multifunction steering wheel. The following views can be displayed:

- **Main:** Digital speedometer with secondary indications.
- **Speed:** Classic representation of the speedometer as a circular instrument with secondary indications in the centre of the dial.

- **Rev counter:** Classic representation of the rev counter as a circular instrument with secondary indications in the centre of the dial.

The amount and content of the information displayed may vary depending on the equipment.

Note



After switching off the ignition, a display appears showing vehicle status information, such as distance travelled.

Note

If warnings are shown about existing faults when the ignition is switched on, it might not be possible to change the settings or display the information as described. If the fault continues, visit a duly qualified specialised workshop. SEAT recommends visiting a SEAT dealership.

Select secondary indications in the "Main" view

The secondary indications **B** or **C** can be individually configured or hidden. Proceed as follows to select the secondary indications:

1. Use the keys  and  to select the right **B** or left **C** secondary indications area.
2. Use the thumbwheel on the multifunction steering wheel to select the desired secondary indication.
3. Confirm your selection by pressing the **OK** button.

Selecting secondary indications in the "Speed" or "Rev counter" views

1. Use the thumbwheel on the multifunction steering wheel to select the desired secondary indication.
2. Confirm the selection by pressing **OK**.

SEAT Digital Cockpit

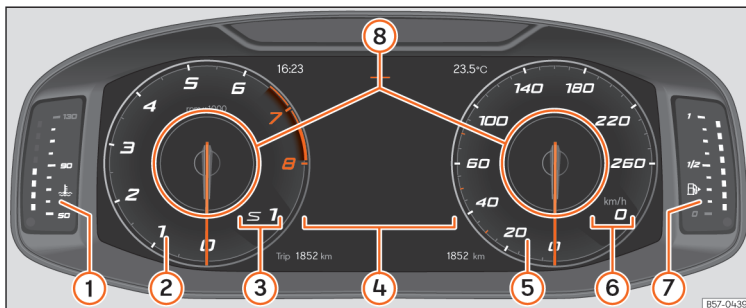


Fig. 2 SEAT Digital Cockpit on the instrument panel (classic view).

- ① **Engine coolant temperature display.**
»» page 18
- ② **Revolution counter.** Revolutions per minute the engine is running »» page 17.
- ③ **Gear engaged or position of the selector lever.**
- ④ **Screen display** »» page 19.
- ⑤ **Speedometer.**
- ⑥ **Digital speed display.**
- ⑦ **Fuel gauge** »» page 17.
- ⑧ **Information Profile** »» page 16.

The SEAT Digital Cockpit is a digital instrument cluster with a high resolution colour TFT display. It has a 3 views accessible using the button **VIEW** of the multifunction steering wheel. By

selecting different information profiles, indications other than the classic circular instruments can be displayed, such as navigation data, multimedia information or travel data.

The 3 views are:

- Classic
- Dynamic
- Navigation

All views will display information on the screen about audio, phone, travel data, vehicle status, navigation and driving aids.

In all views the information displayed in **Information profiles** can be customised »» **Fig. 2**

⑧.

Information profiles

Use the infotainment system menu **☰ > Selection > Digital Cockpit** to choose between the different options for viewing information to be displayed in the SEAT Digital Cockpit.

Classic View

The revolutions per minute and speedometer needles appear along the entire length »» **Fig. 2**.

View 1, 2, 3 or AUTOMATIC¹⁾

Personalisation of the information that appears in the SEAT Digital Cockpit. Only 2 of these items of information can be displayed at the

¹⁾ Pre-set information depending on the selected "Driving mode".

same time, but the user chooses which to display, and in what order, by moving the finger vertically over the dials.

Depending on the version, the Views can be memorised by exiting the menu or keeping the **View** button pressed.

- **Consumption.** Graphic representation of the current consumption and digital display of the average consumption.
- **Audio.** Digital display of the current audio playback.
- **Altitude.** Digital display of the current altitude above sea level.
- **Compass.** Digital display of the compass.
- **Destination arrival information.** Digital display of the remaining travelling time, distance to the destination and the estimated time of arrival.
- **Range.** Digital display of the remaining range.
- **Travelling time.**
- **Route guidance.**
- **Journey.** Digital display of the distance travelled.
- **Assist systems.** Graphic representation of different assistance systems.
- **Road signs.** Display of traffic signs detected.
- **Navigation.** Graphical representation of the navigation with arrows.

It may vary based on the features, the number and the contents of the selectable information profiles.

Revolution counter

The rev counter indicates the number of engine revolutions per minute.

Together with the gear-change indicator, the rev counter offers you the possibility of using the engine of your vehicle at a suitable speed.

The beginning of the red zone of the rev counter indicates the maximum speed in any gear after running-in and with the engine hot. However, it is advisable to move the selector lever to **D** or lift your foot off the accelerator before the needle reaches the red zone »» ①.

We recommend that you avoid high revs and that you follow the recommendations on the gear-change indicator. See the additional information in »» page 109, *Selecting the optimal gear.*

ⓘ NOTICE

- **To prevent damage to the engine, the rev counter needle should only remain in the red zone for a short period of time.**
- **When the engine is cold, avoid high revs and heavy acceleration and do not make the engine work hard.**

🌱 For the sake of the environment

Changing up a gear early will help you to save fuel and minimise emissions and engine noise.

Fuel gauge





Fig. 3 Basic instrument cluster: fuel gauge.



Fig. 4 SEAT Digital Cockpit instrument cluster: fuel gauge.

Indicator lamps

 Its lights up yellow. Fuel tank almost empty. The fuel reserve level has been reached >>> . Refuel as soon as you have the opportunity. When the fuel level is very low, the lower diode also flashes red.

The display only works when the ignition is switched on.

The fuel range is displayed on the instrument panel.

You can consult the tank capacity of your vehicle in >>> page 321.

 WARNING

When driving with low fuel, the vehicle may stall in traffic and cause accidents and severe injuries.

- If the fuel tank level is too low, fuel could reach the engine irregularly, particularly when driving up or down slopes.
- The steering system and the assistant systems and brakes do not work when the engine is running irregularly or switches off due to lack of fuel or an irregular supply thereof.
- SEAT recommends always refuelling when the tank is approximately one quarter full, to prevent the vehicle from stopping due to a lack of fuel.

 NOTICE

Never run the fuel tank completely dry. An irregular fuel supply can cause misfiring and unburnt fuel could enter the exhaust system. The catalytic converter or the particulate filter may get damaged!

 Note

The small arrow on the fuel gauge next to the fuel pump symbol points out towards the side of the vehicle with the fuel tank flap.

Coolant temperature indicator.

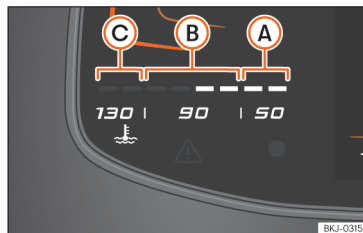


Fig. 5 Basic digital instrument cluster: engine coolant temperature indicator.

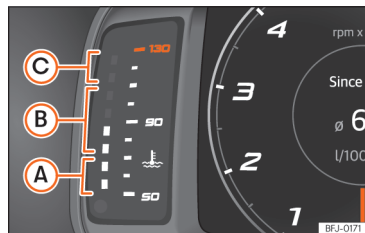



Fig. 6 SEAT Digital Cockpit digital instrument cluster: engine coolant temperature indicator.

- A Cold zone.** The engine has not reached operating temperature yet. Avoid high engine speeds and stressing the engine if it has not reached operating temperature.
- B Normal zone.** At high outside temperatures and when making the engine work hard, the diodes may continue lighting up and reach the upper zone. This is no cause for concern, provided the control lamp does not light up .
- C Warning area.** When the engine is working hard, especially at high outside temperatures, the diodes may light up in the warning area.

The coolant temperature gauge only works when the ignition is switched on.

Control and warning lamps

**Fault in the engine coolant system**

The LED flashes red.

Engine coolant

The lamp lights up red.

The motor coolant temperature is too high or the motor coolant level is too low.

- **Stop driving!** Stop the vehicle at the first opportunity and in a safe place.
- Switch off the engine and let it cool down.
- Check the coolant level in the coolant expansion tank »» page 272.

If the warning lamp does not go out even though the motor coolant level is correct, do not continue to drive or leave the engine running. Seek specialist assistance.

NOTICE

- **To ensure a long useful life for the engine, avoid high revs, driving at high speed and making the engine work hard for approximately the first 15 minutes when the engine is cold. The engine's warming-up phase also depends on the outside temperature. If necessary, use the engine oil temperature as a guide »» page 21.**

- **Additional lights and other accessories in front of the air inlet reduce the cooling effect of the coolant. At high outside temperatures and high engine loads, there is a risk of the engine overheating.**
- **The front spoiler also ensures proper distribution of the cooling air when the vehicle is moving. If the spoiler is damaged this can reduce the cooling effect, which could cause the engine to overheat. Seek specialist assistance.**

Status display**Possible indications on the instrument panel display**

The instrument cluster can display a variety of information, superimposed according to the vehicle's equipment:

- Doors, bonnet and rear lid open
- Warning and information messages
- Odometer
- Time »» page 23
- Indications of the radio and navigation system
- Indications of the phone
- Outside temperature
- Compass indication
- Selector lever positions

- Gear-change recommendation
- Display of travel data (multifunction display) and menus for different settings »» page 21
- Service interval display »» page 23
- Speed warning
- Speed warning for winter tyres
- Start-Stop system status display »» page 118
- Signs detected by the traffic signal detection system
- Indication of active cylinder management status (ACT®) »» page 109
- Low consumption driving
- Assistant systems display
- Personalization: greeting »» page 184
- Engine oil temperature
- Indication of radiator fan operation with engine stopped¹⁾

Doors, bonnet and rear lid open

When the vehicle is unlocked and while driving, the instrument panel display shows if any of the doors, the bonnet or rear lid are opened and, in some cases, it is also indicated by an audible warning.

¹⁾ Valid for the basic digital instrument cluster.

Selector lever positions

The current position of the selector lever is shown on the side of the lever and on the instrument panel display. When the lever is in the **D/S** position or in the Tiptronic position, in some cases, the gear engaged in each case is shown on the instrument panel display.

Outside temperature indicator

If the outside temperature is lower than approximately +4 °C (+39 °F), the "ice crystal symbol" ❄️ also lights up on the outside temperature indicator. This symbol remains lit until the outside temperature exceeds +6 °C (+43 °F) »» ⚠️.

In the following situations, the displayed exterior temperature may be higher than the actual temperature due to the heat emitted by the motor:

- When the vehicle is stationary
- When driving very slowly

Gear-change recommendation

While driving, the instrument panel of certain vehicles may indicate a gear recommendation for saving fuel »» page 109.

Odometer

The *odometer* records the total distance travelled by the vehicle.

The *partial odometer (trip)* shows the distance travelled since the last time it was reset to zero.

- Set the odometer to zero via the Infotainment system or the multifunction steering wheel »» page 21.

Speed warning for winter tyres

If the maximum set speed is exceeded, this is displayed on the instrument cluster display.

The speed warning can be set in the infotainment system (⊞ > **Settings** > **Tyres**; OR ⊞ > **Exterior settings** > **Tyres**) »» page 36.

Compass indication

Depending on the equipment, when the ignition is on, the instrument panel display indicates the direction in which you are driving with a symbol, e.g. NW for Northwest.

When the Infotainment system is on and there is no route guidance active, the graphic representation of a compass is also shown.

Low consumption driving Ⓢ

Depending on the equipment, when driving, the Ⓢ display appears on the instrument panel when the vehicle is in low consumption status due to active cylinder management (ACT®) »» page 109.

Radiator fan operation indication¹⁾

This indication is displayed after switching off the ignition when the radiator fan is still running. The operating time of the radiator fan can depend on:

- Exhaust gas treatment, e.g. during regeneration of the particulate filter.
- Active brake cooling after descending a slope.
- Dissipation of heat from the engine after high stress, e.g. after a very long drive.

Destination information¹⁾

If route guidance is enabled, the expected travel time and the distance to the destination are displayed.

Navigation indications¹⁾

If route guidance is activated, the direction of travel is shown by arrows.

¹⁾ Valid for the basic digital instrument cluster.

⚠ WARNING

Even when the outside temperature is higher than freezing temperature, some roads and bridges could be frozen.

- The “ice crystal symbol” indicates that there may be a risk of freezing.
- At outside temperatures above +4 °C (+39 °F), there may be ice even when the “ice crystal symbol” is not on.
- The outside temperature sensor takes a guideline measurement.

📄 Note

- There are different instrument panels and therefore the versions and instructions on the display may vary. In the case of displays without warning or information texts, faults are indicated exclusively by the control warning lamps.
- Some settings can be saved in the user accounts of the personalization function and can therefore be changed automatically when switching user accounts >>> page 184.
- Some indications on the instrument panel screen may be concealed by a sudden event, e.g. an incoming call.
- Depending on the equipment, some settings and instructions can be carried out or displayed on the infotainment system as well.

- If there are several warnings at the same time, the symbols will be displayed one after the other for a few seconds. The symbols will stay on until you remove the cause.
- If when switching on the ignition warnings are shown about existing faults, it might not be possible to change the settings or show the information as described. In this case, go to a specialised workshop and request a repair.

Driving data display

The driving data display shows a range of driving data and consumption values.

Change from one display to another

- Turn the right thumbwheel of the multifunction steering wheel >>> page 31.

Changing memory

- While in **Driving data > General information** press **OK** on the multi-function steering wheel to switch between the 3 memories:¹⁾
 - **Since start:** The memory is deleted if the journey is interrupted for more than 2 hours.
 - **Since refuel:** Display and storage of the journey data and the consumption values collected. When refuelling, the memory is deleted.

- **Long-term:** This memory contains travel data up to a maximum of 19 hours and 59 minutes or 99 hours and 59 minutes, or up to a maximum of 1999.9 km or 9999.9 km. When one of these values is exceeded (varies depending on the version of the instrument cluster), the memory is deleted.

Delete journey data presets

- Select the memory you want to delete - either “**Since start**” or “**Long-term**”. The “**Since refuelling**” memory is only cleared when refuelling.
- Press and hold the **OK** button on the multi-function steering wheel for approximately 2 seconds.

Select the instructions

In the Infotainment system, in the menu Vehicle settings, you can display different travel data >>> page 35.

- **Current consumption:** The current fuel consumption display operates throughout the journey, in litres/100 km; and with the engine running and the vehicle stopped, in litres/hour.
- **Average consumption:** The average fuel consumption is displayed after driving for approximately 300 metres.

¹⁾ This will show all data on the display at the same time: distance travelled, average consumption, average speed and range.

- **Travelling time:** This indicates the hours (h) and minutes (min) since the ignition was switched on.
- **Range:**²⁾ Approximate distance in km that can still be travelled if the same driving style is maintained.
- **Distance travelled:** Distance covered in km (miles) after switching on the ignition.
- **Average speed:** The average speed will be shown after driving for approximately 100 metres.
- **Digital speed:** Current speed displayed in digital format.
- **Eco tips:** Recommendation messages are displayed on how to reduce consumption through good driving practices, e.g. **Air conditioning on: close the window.**



Setting the trip recorder (trip) to zero.

- While in **Driving data**, turn the right thumb-wheel of the multifunction steering wheel until **TRIP**.
- Keep the **OK** button on the multi-function steering wheel pressed for approximately 2 seconds.

Setting a speed warning

- Select the display **Warning** at --- km/h or **Warning** at --- mph.
- Press the **OK** button on the multi-function steering wheel to memorise the current speed and activate the warning.
- **Activate:** set the desired speed within 5 seconds by rotating the wheel on the multi-function steering wheel. Next, press the **OK** button again or wait for a few seconds. The speed is saved and the warning activated.
- **Deactivate:** press the **OK** button. The stored speed is deleted. The warning can be set for speeds of between 30 and 250 km/h (18 and 155 mph).

Oil temperature display


The engine reaches its operating temperature when, under normal driving conditions, the oil temperature is between **80°C** (176°F) and **120°C** (248°F). If a great effort is required from the engine and the outside temperature is high, the engine oil temperature may increase. This is not a problem as long as the warning lamps  or  **»» page 278** do not appear on the display.

Warning and information messages

The system runs a check on certain components and functions when the ignition is switched on and while the vehicle is moving. Faults are displayed on the instrument cluster display as red and yellow warning symbols **»» page 11** accompanied by messages and, depending on the case, even an audible warning. The representation of the messages and symbols may vary depending on the version of the instrument panel.

Existing faults can also be checked manually. To do this, open the **Vehicle status** **»» page 30** menu.

Priority 1 warning (in red)

The symbol lights up or flashes (in part accompanied by audible warnings).  **Stop driving!** Danger! Check the fault and eliminate the cause. If necessary, seek professional assistance.

Priority 2 warning (in yellow)

The symbol lights up or flashes (in part accompanied by audible warnings). Operating faults or the lack of operating fluids can cause damage to the vehicle or a fault. Check the faulty function as soon as possible. If necessary, seek professional assistance.

²⁾ Valid for the SEAT Digital Cockpit.

Reference to information in the owner's manual



Further information on any warnings can be found in the owner's manual.

Information message

It provides information about processes in the vehicle.

Date and time

Setting the time on the infotainment system

- Press  >  **Settings** >>> page 32.
- Select the menu option **Date and time**.
- **OR** set the date and time in the instrument cluster's **Service** menu.

Service Menu

In the Service menu various settings can be adjusted depending on the features.

Open the Service menu

Select the **Range** information profile while in the **Driving data** menu, and keep the **OK** key pressed on the multifunction steering wheel for approximately 4 seconds. When it is released, the **Service** menu will be displayed.

Now you can browse through the menu using the keys on the multifunction steering wheel as usual.

Restart the service interval indicator

Select the **Service** menu and follow the instructions on the instrument cluster display.

Reset the oil service

Select the **Reset Oil service** menu and follow the instructions on the instrument cluster display.

Identifying letters on engine (LDM)

Select the menu **Engine code**. The identifying letters of the engine will be shown on the instrument cluster display at the bottom left.

Setting the date and time

Select the Service menu and follow the instructions on the instrument cluster display.

Service intervals

The service interval indicator appears on the instrument cluster display and in the infotainment system.

There are different versions of instrument clusters and infotainment systems, so the versions and instructions on the screens may vary.

SEAT distinguishes between services with engine oil change (e.g. Oil change service) and services without engine oil change (e.g. Inspection).

In vehicles with **Services established by time or mileage**, the service intervals are already pre-defined.

In vehicles with **LongLife Service**, the intervals are determined individually. Thanks to technological progress, maintenance work has been greatly reduced. The oil only needs to be changed when the vehicle requires it. To calculate this change (max. 2 years), the vehicle's usage conditions and individual driving styles are considered. The advance warning first appears 20 days before the date established for the corresponding service. The kilometres (miles) remaining until the next service are always rounded up to the nearest 100 km (miles) and the time is given in complete days. The current service message cannot be viewed until 500 km after the last service. Prior to this, only lines are visible on the display.


Inspection reminder

If a service or an inspection has to be carried out soon, a **service reminder** will be displayed when the ignition is switched on.

The figure shows the kilometres that can still be travelled or the time until the next service.

Service due

When **the time for a service** or an **inspection** comes, an audible warning will be emitted when the ignition is switched on and the fixed


key symbol  may appear on the instrument cluster for a few seconds, along with one of the following messages:

- **Service now!**
- **Please have your vehicle inspected**
- **Oil change service due!**
- **Oil change service and inspection due!**

Consult a service notification

With the ignition switched on, the engine off and the vehicle at a standstill, the current service notification can be read:

Check the date of the current service on the infotainment system:

- Press the function button  **Vehicle > Settings > Service.**

Checking the date on the digital instrument cluster:

- The date of the service can only be read through the **Service >>> page 23** menu.

Resetting the service interval indicator

If the service was **not** carried out by a SEAT dealership, the display can be reset as follows:

- The service interval indicator can only be reset through the **Service >>> page 23** menu.

Do not restart the indicator between the service intervals, otherwise the information displayed will be incorrect.

If the oil change service is reset manually, the service interval indicator changes to a fixed service interval, also in vehicles with **Flexible oil change service.**

Note

- The service message disappears after a few seconds, when the engine is started or when the OK button is pressed on the multi-function steering wheel.
- In vehicles with the LongLife system in which the battery has been disconnected for a long period of time, it is not possible to calculate the date of the next service. Therefore the service interval indicator may not be correct. In this case, bear in mind the maximum permitted service intervals >>> page 302.
- If you reset the display manually, the next service interval will be indicated as in vehicles with fixed service intervals. For this reason we recommend that the service interval indicator be reset by an authorised dealer.

Drowsiness monitor

Introduction



Fig. 7 On the instrument cluster display: Drowsiness monitor symbol.

The drowsiness monitor informs the driver whether his or her driving behaviour is indicative of fatigue.

The drowsiness monitor determines the driver's driving behaviour and uses this information to assess driver fatigue. If the system detects that the driver is tired, it indicates this visually on the instrument cluster display by means of a control or warning lamp in combination with a supplementary text message. It also issues an audible warning >>> page 26. The text message on the instrument cluster display is displayed for 4 to 6 seconds.

Operating conditions

Driving behaviour is assessed only at speeds above 65 km/h and thereafter only at speeds above 60 km/h.

WARNING

The drowsiness monitor is no substitute for the driver's attention and only works within the limits of the system. Therefore, the drowsiness monitor may not detect that the driver is tired in all situations and may not give a warning or may give a delayed or unintended warning. There is a risk of accidents and serious or even fatal injuries.

- Always pay proper attention and do not rely solely on the system. The driver is responsible for his or her fitness to drive at all times.
- Note the limits of the system >>> page 25.
- Never drive a vehicle when you are tired.
- During long journeys, take regular and sufficient breaks.
- Follow the information on the instrument cluster display and respond as prompted. >>> page 26.

System limits affecting the drowsiness monitor

The drowsiness monitor has system-related limitations. The following conditions may limit the drowsiness monitor's operation, or prevent it from operating at all:

- Speeds below 60 km/h.
- Speeds over 130 km/h.
- Roads with many curves.
- Roads in poor condition.
- Adverse weather conditions.
- Roadworks.
- Sporty driving style.
- Towing a heavy or very long trailer >>> page 232.
- The driver is distracted.

Note

The drowsiness monitor has been developed for use only when driving on motorways and main roads in good condition.

Microsleep

No urgent warning is issued in case of microsleep.

Restarting the drowsiness monitor

The drowsiness monitor restarts in the following situations:

- If the ignition is switched off.
- The driver's seat belt is unbuckled and the driver's door is open.
- The vehicle has been stopped for more than 30 minutes.

Driving with the drowsiness monitor

Connection and disconnection

Depending on the country, the drowsiness monitor is activated whenever the vehicle's drive system is activated. In this case, the infotainment system displays an overview of the individual systems and automatically activated functions in the input menu.

If desired, you can switch off the drowsiness monitor manually in the infotainment system:

1. Open the **Assistance systems** menu.
2. Switch the drowsiness monitor on or off in the corresponding submenu >>> page 35..

Sensitivity adjustment

You can manually adjust the sensitivity of the drowsiness monitor and therefore influence how quickly the system reacts to your driving behaviour.

In the infotainment system:

1. Open the **Assistance systems** menu.
2. Open the **Drowsiness monitor**.
3. Select the sensitivity in the **Sensitivity** sub-menu »» page 35.


Concealing messages via the multi-function steering wheel

1. Press the **OK** button on the multifunction steering wheel.


Drowsiness monitor warning levels

If the system detects that the driver is tired, it indicates this visually on the instrument cluster display by means of a control or warning lamp in combination with a supplementary text message and an audible warning. The warning is issued at three levels.

Drowsiness monitor warning - Level 1


 The system has detected that the driver is becoming tired. An audible signal sounds. A white control lamp and a text message are shown on the instrument cluster display. Consider taking a break.

Drowsiness monitor warning - Level 2


 The system has detected that the driver is becoming increasingly tired. An audible signal sounds. A red warning lamp is shown

on the instrument cluster display together with a text message. Consider taking a break soon.

Drowsiness monitor warning - Level 3

 Serious risk identified. An audible signal sounds. A red warning lamp is shown on the instrument cluster display together with a text message. Serious traffic risk. Stop driving as soon as possible and proceed urgently to the nearest place where you can take a break.

Time-related information

 The drowsiness monitor detects that the driver has been driving for 4.5 hours without a break and without any recognised fatigue. A white control lamp and a text message are shown on the instrument cluster display. Consider taking a break.

Troubleshooting

 **Availability of the drowsiness monitor is restricted**

An audio signal sounds. A yellow control light appears along with a text message on the instrument cluster screen. The availability of the drowsiness monitor is restricted.

- Fault or malfunction. Deactivate and reactivate the vehicle drive system.
- If the problem persists, visit a duly qualified workshop. SEAT recommends that you visit an official dealer.



The drowsiness monitor is not available

An audio signal sounds. A yellow control lamp appears in combination with the yellow centre lamp. A text message is also shown on the instrument cluster screen and in the **vehicle status** menu.

- Fault or malfunction. Deactivate and reactivate the vehicle drive system. Check the drowsiness monitor settings in the infotainment system »» page 35.
- The system limits have been exceeded.
- If the problem persists, visit a duly qualified workshop. SEAT recommends that you visit an official dealer.

Road signs detection system

Introduction¹⁾

The dynamic road signs display records standard road signs using a camera located in the central upper area of the windscreen, housed in the compartment located on the base of the interior mirror. It provides information about speed limits and overtaking prohibitions.

Within its limitations, the system also displays a additional sign to indicate aspects such as temporary prohibitions. Even on routes without signs, the system can, if necessary, display the applicable speed limits.

Road sign recognition does not work in all countries. Keep this in mind when travelling abroad.

The dynamic road sign display system is activated whenever the ignition is switched on.

Shown on the display

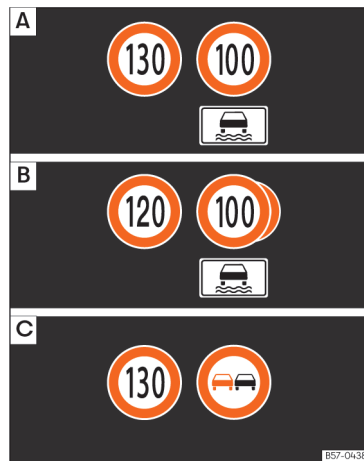


Fig. 8 On the instrument cluster display: examples of recognised speed limits or overtaking prohibitions with their respective additional signs.

In Germany, on motorways and normal roads for vehicles, besides speed limits and overtaking provisions the system also displays end of restriction signs. In all other countries the currently valid speed limit is displayed instead.

The road signs detected by the system are displayed on the instrument cluster display >>> Fig. 8 and, depending on the navigation system fitted in the vehicle, in the infotainment system as well.

Display of road signs

After checking and evaluating the information from the camera, the navigation system and the current vehicle data, the system displays up to three current road signs [B] with their additional signs.

- **First:** The sign that is currently valid for the driver is shown on the left side of the display. For example, a maximum speed limit of 130 km/h (100 mph) [A].
- **Second:** A sign valid only in certain circumstances, e.g. 100 km/h (60 mph) is shown second, together with the additional rain sign.
- **Additional sign:** Displays the circumstances (rain, times of day, fog, etc.) under which the displayed speed limit is in force.
- **Third:** Thirdly, a sign prohibiting overtaking is partially displayed. If there is no conditional speed limit and overtaking is prohibited, the latter sign will be displayed in second place [C].

¹⁾ Not available in all markets.

No entry sign

The road sign recognition system gives a warning on the instrument cluster when a no entry sign is passed on a one-way road or an entrance to a motorway or highway.

WARNING

The technology in the road sign detection system cannot change the limits imposed by the laws of physics and only works within the system's limits. The increased convenience provided by the dynamic road sign display system should not lead you to take any risks. The system is not a replacement for driver awareness.

- Adapt your speed and driving style to suit visibility, weather, road and traffic conditions.
- Poor visibility, darkness, snow, rain and fog may result in the system not displaying road signs, or not displaying them correctly.
- If the camera's field of view is dirty, covered or damaged, the operation of the system may be affected.

WARNING

The driving recommendations and traffic indications shown on the road sign detection system may differ from the actual current traffic situation.

- The system cannot recognise or display all road signs correctly.
- Road signs and traffic regulations have priority over the recommendations and displays provided by the system.

Limited operation

The road sign detection system has certain limitations. The following cases may cause the system to function in a limited way or not at all:

- Poor visibility, e.g. in snow, rain, fog or intense mist.
- Dazzling, e.g. caused by head-on traffic or by the sun.
- Driving at high speed.
- If the camera is covered or dirty.
- If the road signs are partially or totally obstructed, e.g. by trees, snow, dirt or other vehicles.
- Non-compliant road signs.
- Damaged or bent road signs.
- Variable message signs on signalling gantries (variable indication of road signs by LEDs or other lighting units).

- If outdated maps are used in the navigation system.
- Adhesives affixed to vehicles that depict road signs, e.g. speed limits on lorries.

Driving with the speed warning function

Operating conditions

The speed warning function gives warnings at speeds above 20 km/h.

Connection and disconnection

Depending on the country, the speed warning function is always activated when the ignition is switched on. In this case, the infotainment system displays an overview of the individual systems and automatically activated functions in the input menu.

If desired, you can deactivate the speed warning manually in the infotainment system:

1. Open the **Assistance systems** menu.
2. Switch the speed warning on or off in the corresponding submenu.

Activating and deactivating the audible warning

In the infotainment system:

1. Open the **Assistance systems** menu.
2. Open the **Speed Warning**.
3. Activate or deactivate the audible warning under the corresponding option
»» page 35.

Note

The audible warning is activated whenever the ignition is switched on.

Adjusting the warning thresholds

You can manually adjust the warning thresholds of the speed warning function.

In the infotainment system:

1. Open the **Assistance systems** menu.
2. Open the **Speed Warning**.
3. To select the level of the warning thresholds, tap √ in the **Overtaking warning**
»» page 35 menu option.

Note

When the vehicle's ignition is switched on, the warning thresholds for the speed warning are always reset to the default value.

Activation and deactivation of the speed change warning tone

The speed change warning tone provides the driver with audible information about a change in the speed limits. If desired, you can manually switch off the change tone.

In the infotainment system:

1. Open the **Assistance systems** menu.
2. Open the **Speed Warning**.
3. Activate or deactivate the change tone under the corresponding option
»» page 35.

Concealing fault messages via the multi-function steering wheel

1. Press the **OK** button on the multifunction steering wheel.

Trailer mode

For vehicles with a factory-installed towbar and a trailer with electrical connection to the vehicle, the recognition of traffic signs that may apply to the vehicle when towing a trailer, for example applicable speed limits and no overtaking signs, can be activated or deactivated in the vehicle settings menu in the infotainment system.

In trailer mode, the recognition of valid speed limits can be adjusted to suit the type of trailer and country-specific legal requirements.

In the infotainment system:

1. Open the **Assistance systems** menu.
2. Open **Trailer detection**.
3. To adapt the warning threshold to the trailer mode, tap on √ in the **Overtaking warning** menu option.

Speed warning function warning levels

If the system detects that the speed limit has been exceeded, it will indicate this visually on the instrument cluster display by flashing the speed limit detected by the system and, depending on the configuration, will also issue an audible warning. A warning is issued at two levels.



Fig. 9 On the instrument cluster display: violation of the detected speed limit (illustration).

Speed warning - Level 1

Speed limit violation detected. The speed limit detected by the system flashes continuously on the instrument cluster and, depending on the equipment, on the front display »» Fig. 9.

Speed warning - Level 2

Progressive violation of the speed limit has been detected.

An audible signal sounds. The speed limit detected by the system flashes continuously on the instrument cluster and, depending on the equipment, on the front display »» Fig. 9.

Note

- The second warning level is activated if the speed remains above the limit.
- The second warning level is cancelled again when the driver actively reduces the speed.

Troubleshooting

  Advanced road sign recognition is not available

A yellow control lamp appears on the instrument cluster display in combination with the central yellow lamp. A text message is also shown on the instrument cluster display and in the **vehicle status** menu.

Road sign detection system messages:

- **"Dynamic road sign assist: please clean the windscreen."**
 - The windscreen is dirty in the area of the camera or the camera view is impaired by weather conditions. Clean the windscreen »» page 305.
 - The camera's view is impaired by added parts or stickers. Keep the area around the camera clear »» page 135.
 - The camera has been moved or damaged, for example due to damage to the windscreen. Check whether the damage can be seen.
- **"Error: dynamic road sign assist"**
 - There is a fault in the system. Have the system checked by a specialised workshop.
- **"Speed warning is currently unavailable"**
 - The speed warning function of the road sign detection system is faulty. If the problem persists, have the system checked by a specialised workshop.
- **"Dynamic road sign assist currently restricted"**
 - The navigation system is not transmitting data. Check if the navigation system has updated maps.
 - **OR:** the vehicle is in a region not included on the navigation system's map. If the problem persists, have the system checked by a specialised workshop.

Outside the operating region for advanced road signs recognition

A message appears on the instrument cluster display with the following text **"Road sign assist: outside the usage area"**.

- No data available for this region. The advanced road signs recognition system is not supported in the country you are currently driving in.



Speed warning system partially deactivated

A white control lamp is shown on the instrument cluster display. The default configuration of the speed warning has been changed:

- Check whether the speed warning is switched off »» page 28.
- Check if the audible warning is activated »» page 28.
- Check if the default warning threshold has been changed »» page 28.

Instrument cluster operation

Introduction

With the ignition switched on, it is possible to read the different functions of the display by scrolling through the menus.

In vehicles with multifunction steering wheel, the multifunction display can only be operated with the steering wheel buttons.

Some menu options can only be read when the vehicle is at a standstill.

Instrument panel menus

The number of menus and information items available will depend on the vehicle's electronics and features.

- Vehicle status >>> page 22.
- Driving data >>> page 21.
- Assist systems.
 - Front Assist On/Off >>> page 148
 - ACC (only display) >>> page 143
 - Lane Assist On/Off >>> page 151
 - Travel Assist >>> page 153
 - Side Assist On/Off >>> page 156
 - Speed warning On/Off >>> page 28
- Navigation.
- Audio.
- Telephone.

WARNING

Distracting the driver in any way can lead to an accident and cause injuries.

- Never use the menus on the instrument panel display while the vehicle is in motion.

NOTICE

After charging or changing the 12-volt battery, check the system settings. If the power supply is interrupted, the system settings might be incorrect or deleted.

Operation using the multifunction steering wheel

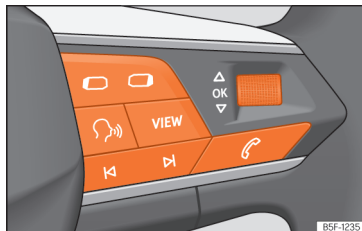




Fig. 10 Right side of multifunction steering wheel: buttons to the menus and informative indications on the instrument panel (depending on the version).

As long as a priority 1 >>> page 22 warning is active, it will not be possible to access any menu. Some warnings can be confirmed and hidden with the **OK** button of the multifunction steering wheel >>> Fig. 10.

Select a menu or an informative display

- Switch the ignition on.
- If a message or vehicle symbol is displayed, press the **OK** button >>> Fig. 10; several times if necessary.
- To change menus, use  or  buttons.
- To open the menu or the information displayed, press the **OK** button or wait a few seconds until the menu or the informative display opens automatically.

Changing menu settings

- In the menu displayed, turn the right thumb-wheel of the multifunction steering wheel until the desired option of the menu is highlighted. The option appears framed.
- Press the **OK** button to make the required modifications. A mark indicates that the system or function is activated.

Back to menu selection

- Press the  or  button.

Infotainment system operation and displays

Introduction

The infotainment system brings together important vehicle functions and systems into a single central control unit, e.g. air conditioning, menu settings, radio equipment and the navigation system.

The actual number of menus available and the name of the various options will depend on the vehicle's electronics and equipment.

General operating information

General information on the operation of the infotainment system, as well as on the warning and safety instructions that must be taken into account, is found in >>> **page 195**.

How to move through the different menus and select them

- Switch the ignition on.
- If the infotainment system is off, switch it on.
- The different menus are selected directly on the touch screen using texts, icons or buttons.

If the box is checked ✓, the function is activated.

Pressing the menu button < will always take you to the last menu used.

Any changes made using the settings menus are automatically saved on closing those menus

Scroll bar: Some menus and functions show more content above or below those displayed on the screen at that time, for example, long lists of settings. Press on the scroll bar and pull up or down.

Tutorial

The first time you connect the Infotainment system, a system tutorial will open with a brief description of the main functions and how to use it.

Help

In the **Help** menu can be found more information and tips for using the infotainment system.

WARNING

Any distraction may lead to an accident, with the risk of injury. Operating the Infotainment system while driving could distract you from traffic.

Note

After starting the engine with a 12-volt battery that is heavily discharged or recently replaced, some system settings such as time, date, personalised comfort settings, programming and user accounts might be al-

tered or deleted. Check and correct these settings when the battery is sufficiently charged.

Explanation of the function buttons

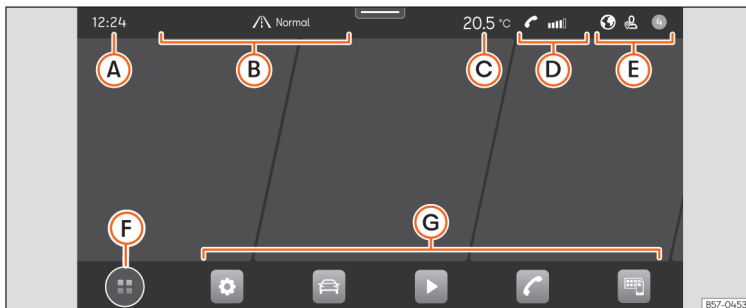


Fig. 11 Schematic representation: Overview of the possible function buttons on the screen.

Top part of the screen

- A** **Current time.**
- B** **Drive profile and navigation information.**
If the user has an active route, both the time and the distance to the destination are displayed. If there is no active route, the drive profile is displayed. On vehicles with no available drive profile, the current address is displayed whenever there is no active route.
- C** **Air conditioning information.** In vehicles with heated steering wheels or windscreen heating, the corresponding icon is displayed when these functions are enabled. If not, the current outside temperature is displayed.

- D** **Telephone information.** Information regarding your mobile device is displayed: available network signal strength, established Bluetooth connection, unanswered calls, new messages, battery status, etc.
- E** **System customisation based on user and notifications.** Some settings can be saved in the user accounts of the personalization function and can therefore be changed automatically when switching user accounts.

Bottom part of the screen

Valid for the infotainment system: Connect System.

- F** Main menu display mode:

- @**: main menu with the 6 main functions divided into 2 screens (3 + 3, customisable by the user by pressing on the function).
- ⊕**: main menu in tile mode [all functions of the Infotainment system].
- G** Direct accesses to the functions of the Infotainment system (up to 10 functions, 5 + 5, customisable by the user). By pressing on the icon, you can select/deselect the functions in question.

Initial configuration wizard

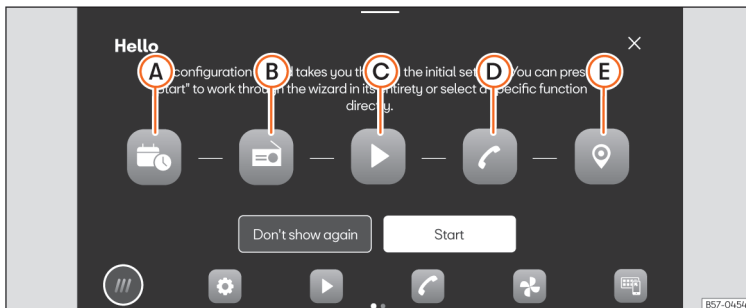


Fig. 12 Schematic representation: Initial configuration wizard

The initial configuration wizard will help you to set up your Infotainment system the first time you switch it on.

Whenever you switch on the infotainment system, the initial setup screen will be displayed
 >>> **Fig. 12** if any parameters have not been set (marked with "✓") or if the **Don't show again** function button has not been pressed.

Function buttons:

- A** Press to set date and time.
- B** Press to search and store to memory the radio stations that have the best reception at that moment.
- C** Press to go to the Online Media settings.
- D** Press to link your mobile phone to the Infotainment system.

- E** Press to select your home and work address using your current position or by manually entering an address.

Don't show again Disables the possibility of changing the settings of the Infotainment system. If you wish to perform the initial settings, you will need to access via **Settings**.

Start Starts up the Configuration Wizard.

End Once one or more settings have been applied, press to finalise the setup in the main menu of the wizard.

- X** Closes the Configuration Wizard.

Assistance systems and vehicle settings

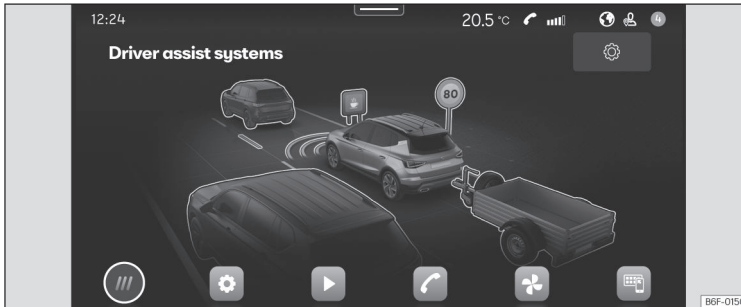


Fig. 13 Schematic representation: Assistance systems and vehicle settings

Clicking on **Driver assistance** from the main menu opens the menu of vehicle assistants and settings.

The number of assistance systems and settings depend on the version and the country in question.

- Park assist >>> **page 160**.
- Activate/deactivate ESC, stabilisation systems and brake assist >>> **page 132**.
- Activate / deactivate the Start-Stop system >>> **page 118**.
- Adaptive cruise control (ACC) >>> **page 143**.
- Lane Assist (lane departure warning system) >>> **page 151**.
- Emergency brake assistance system (Front Assist) >>> **page 148**.
- Fatigue detection.
- Speed warning system >>> **page 28**.
- Side assist >>> **page 156**.
- Lights >>> **page 88**.

Vehicle information

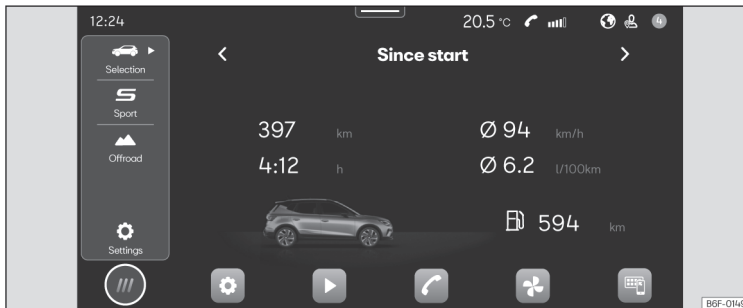


Fig. 14 Schematic representation: Vehicle information and status

Pressing **Vehicle > Selection** in the main menu opens the vehicle info menu with the following submenus:

- **Digital Cockpit:** The different options for displaying the information that will appear in the Digital Cockpit are shown **>>> page 16**.
- **Driving data:** The average consumption, average speed, distance travelled, trip duration and range are shown. It has 3 memories: "Since start", "Long-term" and "Since refuelling".

The "From departure" and "Total calculation" memories can be set to zero from the Infotainment system: **Vehicle > Settings > Instrument cluster > Reset data**.

- **Vehicle status:** The warnings regarding faults, incidents, memorisation of the tyre pressure or information about the next inspection service are displayed.

Safety

Safe driving

Safety first!

WARNING

- This manual contains important information about the operation of the vehicle, both for the driver and the passengers. The other sections of the on-board documentation also contain further information that you should be aware of for your own safety and for the safety of your passengers.
- Ensure that the on-board documentation is kept in the vehicle at all times. This is especially important when lending or selling the vehicle to another person.

Before driving

For your own safety and the safety of your passengers, always note the following points before every trip:

- Make sure that the vehicle's lights and turn signals are working properly.
- Check tyre pressure.
- Ensure that all windows provide a clear and good view of the surroundings.

- Make sure all luggage is secured >>> page 227.
- Make sure that no objects can interfere with the pedals.
- Adjust front seat, headrest and mirrors properly according to your size.
- Ensure that the passengers in the rear seats always have the headrests in the in-use position >>> page 85.
- Instruct passengers to adjust the headrests according to their height.
- Protect children with appropriate child seats and properly fastened seat belts >>> page 52.
- Assume the correct sitting position. Instruct your passengers also to assume a proper sitting position >>> page 38.
- Fasten your seat belt securely. Instruct your passengers also to fasten their seat belts properly >>> page 40.

Factors influencing safety

As a driver, you are responsible for yourself and your passengers.

- Always pay attention to traffic and do not get distracted by passengers or telephone calls.
- Never drive when your driving ability is impaired (e.g. by medication, alcohol, drugs).
- Observe traffic laws and speed limits.

- Always reduce your speed as appropriate for road, traffic and weather conditions.
- When travelling long distances, take breaks regularly - at least every two hours.
- If possible, avoid driving when you are tired or stressed.

WARNING

Driving under the influence of alcohol, drugs, medication or narcotics may result in severe accidents and even loss of life.





- **Alcohol, drugs, medication and narcotics may significantly alter perception, affect reaction times and safety while driving, which could result in the loss of control of the vehicle.**

Safety equipment

Never put your safety or the safety of your passengers in danger. In the event of an accident, the safety equipment may reduce the risk of injury. The following points cover part of the safety equipment in your SEAT¹⁾:

- Optimised seat belts for all seats.
- Seat belt tensioners on the driver, front passenger and rear side seats.
- Seat belt force limiters on the driver, front passenger and rear side seats.

¹⁾ Depending on the version/market.

- Red warning lamp  and, if applicable, seat belt status indication.
- Front airbags for driver and passenger.
- Side airbags for driver and passenger.
- Head airbags on both sides of the vehicle.
- Yellow airbag control lamp .
- Yellow warning lamp **PASSENGER AIR BAG OFF**  on the centre console.
- Yellow warning lamp **PASSENGER AIR BAG ON**  on the centre console.
- Control units and sensors.
- Optimised and height-adjustable headrests¹⁾.
- Adjustable steering column.
- ISOFIX/i-Size anchor points for child seats.
- Child seat top tether attachment points.

The safety equipment mentioned above works together to provide you and your passengers with the best possible protection in the event of an accident. However, these safety systems can only be effective if you and your passengers are sitting in a correct position and use this equipment properly.

Safety is everybody's business.

Correct sitting position of vehicle occupants

Correct position on the seat

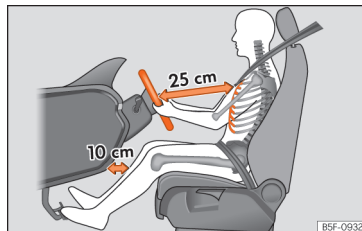


Fig. 15 The correct distance between the driver and the steering wheel must be at least 25 cm (10 inches).

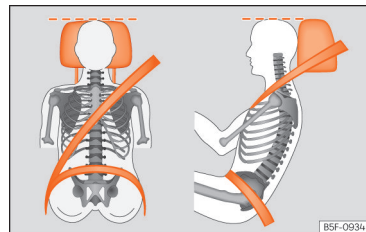


Fig. 16 Correct belt web and headrest positions

The correct sitting positions for the driver and passengers are shown below.

If your physical constitution prevents you from maintaining the correct sitting position, contact a specialised workshop for help with any special devices. The seat belt and airbag can only provide optimum protection if a correct sitting position is adopted. SEAT recommends taking your car in for technical service.

For your own safety and to reduce the risk of injury in the event of an accident or sudden braking or manoeuvre, SEAT recommend the following positions:

¹⁾ The front seats with built-in headrests do not require adjustment.

Valid for all vehicle occupants:

- Adjust the head restraint so that its upper edge is, as far as possible, at the same level as the top of your head, as close to eye level as possible¹⁾ »» page 85. Keep the back of your neck as close as possible to the headrest »» Fig. 16.
- Short people must fully lower the headrest completely²⁾, even if your head is below its upper edge.
- Tall people must fully raise the headrest²⁾.
- Always keep your feet in the footwell while the vehicle is in motion.
- Adjust and fasten your seat belt correctly »» page 40.

The following also applies to the driver:

- Move the seat backrest to an almost upright position so that your back rests completely against it.
- Adjust the steering wheel so that it is at a distance of at least 25 cm (10 inches) from the sternum »» Fig. 15 and can hold it with both hands on the sides, on the outside, with the arms slightly flexed.
- The steering wheel must always point towards the chest and never towards the face.

¹⁾ On seats with adjustable headrests.

- Adjust the seat lengthwise so that you can fully step on the pedals with your knees slightly bent and there is a distance between the knee area and the instrument panel of at least 10 cm (4 inches) »» Fig. 16.
- Adjust the height of the seat so that you can reach the top of the steering wheel.
- Always keep both feet in the footwell so that you have the vehicle under control at all times.

For the passenger, the following applies:

- Move the seat backrest to an almost upright position so that your back rests completely against it.
- Move the seat as far back as possible (minimum 25 cm between the chest and the instrument panel check translation). If you are sitting closer than 25 cm, the airbag system cannot protect you properly.

Number of seats

The vehicle has 5 seats, 2 in the front and 3 in the rear. All seats are fitted with a safety belt.

Check the official documentation for the number of occupants approved for your vehicle.

WARNING

Sitting in an incorrect position may increase the risk of severe or fatal injuries in the event of sudden braking or manoeuvring, in case of collision or accident and if the airbags deploy.

- Before starting the car, all passengers must be sitting in a correct position and stay like that for the entire journey. This also applies to a correct use of the seat belt.
- The maximum number of people in the vehicle is the same as the number of seats with seat belts.
- For children, always use a protection system that is approved and suited for their weight and height »» page 52.
- While driving, always keep your feet in the footwell. Never place them on the seat or the dash panel, for example, or outside the window. Otherwise the airbag and seat belt may offer insufficient protection and also increase the risk of injury in the event of an accident.

Risks of sitting in an incorrect position

If seat belts are worn incorrectly or not at all, the risk of severe or fatal injuries increases. Seat belts can provide optimal protection only if the belt web is properly worn. Incorrect sitting po-

sitions substantially reduce the protective function of seat belts and, therefore, increase the risk of severe or even fatal injuries. The risk of severe or fatal injuries is especially heightened when a deploying airbag strikes a vehicle occupant who has assumed an incorrect sitting position. The driver is responsible for all people, particularly children, inside the vehicle.

The following list contains examples of incorrect sitting positions that could be dangerous for all vehicle occupants.

When the vehicle is in motion:

- Never stand in the vehicle.
- Never stand on the seats.
- Never kneel on the seats.
- Never tilt your seat backrest too far to the rear.
- Never lean against the dash panel.
- Never lie on the rear seats.
- Never sit on the front edge of a seat.
- Never sit sideways.
- Never lean out of a window.
- Never put your feet out of a window.
- Never put your feet on the dash panel.
- Never place your feet on the bench or on the backrest of the seat.
- Never travel in a footwell.
- Never sit on the armrests.

- Never travel without wearing the seat belt.
- Never travel in the luggage compartment.

WARNING

Sitting in an incorrect position increases the risk of severe or fatal injuries in the event of accidents and sudden braking or manoeuvres.

- All occupants must sit correctly during the journey and wear the seat belt correctly.
- Vehicle occupants that are not sitting correctly, not wearing the seat belt or are not at a proper distance of the airbag risk suffering very serious or fatal injuries, especially if the airbags deploy and strike them.

Seat belts

Introduction



Fig. 17 Drivers with properly worn seat belts will not be thrown forward in the event of sudden braking.

Properly worn seat belts hold the occupants in the proper position. They also help prevent uncontrolled movements that may result in serious injury and reduce the risk of being thrown out of the vehicle in case of an accident.

Vehicle occupants wearing their seat belts correctly benefit greatly from the ability of the belts to absorb kinetic energy. In addition, the front part of your vehicle and other passive safety features (such as the airbag system) are designed to absorb the kinetic energy released in a collision. Taken together, all these features reduce the released kinetic energy and conse-

quently, the risk of injury. This is why it is so important to fasten seat belts before every trip, even when "just driving around the corner".

Ensure that your passengers wear their seat belts as well. Accident statistics have shown that wearing seat belts is an effective means of substantially reducing the risk of injury and improving the chances of survival when involved in a serious accident. Furthermore, properly worn seat belts improve the protection provided by airbags in the event of an accident. For this reason, wearing a seat belt is required by law in most countries.

Although your vehicle is equipped with airbags, the seat belts must be fastened and worn. The front airbags, for example, are only triggered in some cases of head-on collision. The front airbags will not be triggered during minor head-on or side collisions, rear-end collisions, overturns or accidents in which the airbag trigger threshold value in the control unit is not exceeded.

Important safety instructions for the use of seat belts

- Always wear the seat belt as described in this section.
- Ensure that the seat belts can be fastened at all times and are not damaged.

WARNING

- If seat belts are worn incorrectly or not at all, the risk of severe injuries increases. The optimal protection from seat belts can be achieved only if you use them properly.
- Never allow two passengers (even children) to share the same seat belt.
- Never unbuckle a seat belt while the vehicle is in motion. Risk of fatal injury.
- The seat belt should never lie on hard or fragile objects (such as glasses or pens, etc.) because this can cause injuries.
- Do not allow the seat belt to be damaged or jammed, or to rub on any sharp edges.
- Never wear the seat belt under the arm or in any other incorrect position.
- Bulky and unfastened clothing (such as an overcoat over a sweater) impairs the proper fit and function of the seat belts, reducing their ability to protect.
- The slot in the seat belt buckle must not be blocked with paper or other objects, as this can prevent the latch plate from engaging securely.
- Never use seat belt clips, fastening rings or similar items to alter the position of the belt webbing.
- Frayed or torn seat belts or damage to the connections, belt retractors or parts of the buckle could cause severe injuries in the

event of an accident. Therefore, you must check the condition of all seat belts at regular intervals.


- Seat belts which have been worn in an accident and have been stretched must be replaced by a specialised workshop. Renewal may be necessary even if there is no apparent damage. The belt anchorage should also be checked.
- Do not attempt to repair a damaged seat belt yourself. The seat belts must not be removed or modified in any way.
- The belts must be kept clean, otherwise the retractors may not work properly.

Seat belt buckled indication



Lights up red


The driver or passenger has not fastened the seat belt.


The control lamp  lights up to remind the driver to fasten their seat belt.

Before starting the vehicle:

- Fasten your seat belt securely.
- Instruct your passengers to fasten their seat belts properly before driving off.
- Protect children by using a child seat according to the child's height and weight
»» page 52.

When starting to drive, if the vehicle's speed exceeds approx. 25 km/h (15 mph) and the seat belts are not fastened or are unfastened while

driving, a warning sound will be heard for a few seconds. In addition, the warning lamp  on the instrument cluster display flashes.

The lamp  goes out when the driver and passenger seat belts are fastened with the ignition switched on.


Rear seat belts fastened display





Fig. 18 Instrument cluster: indication of the status of the rear seat seat belts.



Depending on the version of the model, when the ignition is switched on, the status display of the belts **>>> Fig. 18** informs the driver on the instrument panel display whether the occupants of the rear seats have their seat belts fastened.

Depending on the seat occupancy and the status of the seat belts, the following symbols light up in different colours:

 The white symbol indicates that the corresponding seat is empty.

 A green symbol indicates that the seat is occupied and the occupant is wearing the seat belt.

 A red symbol indicates that the seat is occupied and the occupant is not wearing the seat belt.

If a rear seat occupant unfastens his/her seat belt while driving, the  symbol lights up permanently in red for that seat. In addition, the red warning light  flashes on the instrument cluster screen. If you drive faster than approx. 25 km/h (15 mph), an audio signal sounds for a few seconds.

If a seat belt is fastened or unfastened while driving in any of the rear seats, the seat belt status is displayed for approximately 30 seconds.

Head-on collisions and the laws of physics

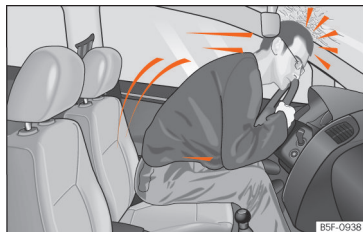


Fig. 19 A driver not wearing a seat belt may be thrown forward violently.



Fig. 20 Any rear seat occupants not wearing a seat belt may be thrown forward violently, hitting the driver who is wearing the seat belt.

The effects of the laws of physics in the case of a head-on collision are easy to explain: the moment a vehicle starts moving, a type of energy called "kinetic energy" starts acting on both the vehicle and its passengers.

The amount of "kinetic energy" depends on the speed of the vehicle and on the weight of the vehicle and of its passengers. The taller they are, the more energy there is to be "absorbed" in the event of an accident.

The most significant factor, however, is the speed of the vehicle. If the speed doubles from 25 km/h (15 mph) to 50 km/h (30 mph), for example, the corresponding kinetic energy is multiplied by four.

Even at speeds of 30 km/h (19 mph) to 50 km/h (30 mph), the forces acting on bodies in a collision can easily exceed one tonne (1000 kg). At greater speed these forces are even higher.

Vehicle occupants not wearing seat belts are not "attached" to the vehicle. In a head-on collision, they will move forward at the same speed their vehicle was travelling just before the impact. This example applies not only to head-on collisions, but to all accidents and collisions.

Even at low speeds the forces acting on the body in a collision are so great that it is not possible to brace oneself with one's hands. In the event of a head-on collision, vehicle occupants not wearing a seat belt will be thrown uncontrollably forward and will collide, for example, against the steering wheel, dash panel or windscreen »» Fig. 19.

It is also important for rear passengers to wear seat belts properly, as they could otherwise be thrown forward violently through the vehicle interior in an accident. If a rear seat occupant is not wearing a seat belt, they are not only endangering themselves but also the occupants of the front seats »» Fig. 20.

Fastening and unfastening the seat belt

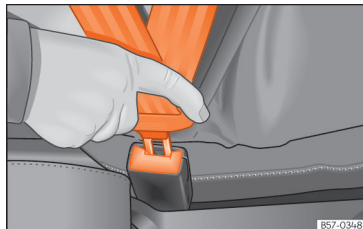


Fig. 21 Insert the latch plate of the seat belt into the buckle.

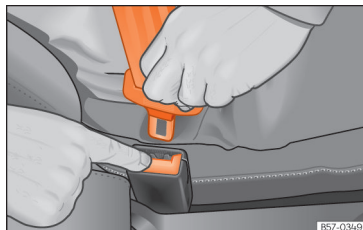


Fig. 22 Release the seat belt's latch plate.

Properly worn seat belts hold the vehicle occupants in the position that best protects them in the event of an accident or sudden braking »» △.

Fastening the seat belt

Fasten your seat belt before each trip.

- Adjust the front seat and headrest correctly »» page 38.
- Engage the seat backrest of the rear seat in an upright position »» △.
- Pull the latch plate and place the belt webbing evenly across your chest and lap. Do **not** twist the seat belt when doing so »» △.
- Insert the buckle plate in the buckle of the correct seat »» Fig. 21.
- Pull the belt to ensure that the latch plate is securely engaged in the buckle.

Releasing the seat belt

Only unfasten the seat belt when the vehicle has come to a standstill » » » .

- Press the red button on the buckle » » » **Fig. 22**. The latch plate is released from the buckle.
- Guide the belt back by hand so that it rolls up easily and does not damage the trim.

WARNING

- The seat belt cannot offer its full protection unless the seat backrest is in an upright position and the seat belt is worn correctly, according to your size.
- Unbuckling your seat belt while the vehicle is in motion can cause severe or fatal injuries in the event of an accident or sudden braking.
- The seat belt itself, or a loose seat belt, can cause severe injuries if the belt moves from hard areas of the body to soft areas (e.g. the stomach).

Correct position of the seat belt

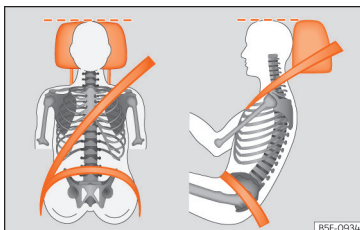


Fig. 23 Correct seat belt and headrest positions, viewed from front and the side.

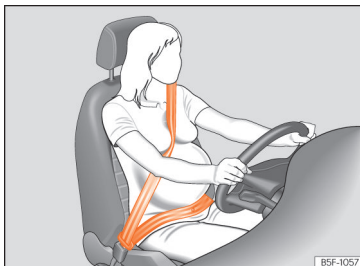


Fig. 24 Position of seat belt during pregnancy.

Seat belts offer their maximum protection in the event of an accident and reduce the risk of sustaining severe or fatal injuries only when they are properly positioned. Furthermore, if the webbing is correctly positioned, the seat belt

will hold the vehicle occupants in the optimum position to ensure the airbag provides the maximum protection. The seat belt must therefore always be worn and the webbing correctly positioned.

Incorrectly worn seat belts can cause severe or even fatal injuries » » » **page 38, Correct sitting position of vehicle occupants.**

- The shoulder part of the seat belt must lie on the centre of the shoulder, never across the neck or the arm, under the arm or behind the shoulder.
- The lap part of the seat belt must lie across the pelvis, never across the stomach.
- The seat belt must lie flat and fit comfortably. Pull the belt tight if necessary to take up any slack.

In the case of **pregnant women**, the seat belt should pass uniformly over the chest and as low as possible through the pelvic area with the strap flat so it does not press down on the abdomen; in addition, it must be used throughout the entire pregnancy » » » **Fig. 24**.

Adapting the position of the belt webbing to your size

The position of the seat belt can be adapted by adjusting the height of the front seats.

⚠ WARNING

An incorrectly worn seat belt web can cause severe or fatal injuries in the event of an accident.

- The shoulder part of the seat belt must lie on the centre of the shoulder, never across the neck or the arm.
- The seat belt must lie flat and fit comfortably on the torso
- The lap part of the seat belt must lie across the pelvis, never across the stomach. The seat belt must lie flat and fit comfortably on the pelvis. Pull the belt tight if necessary to take up any slack.
- In the case of pregnant women, the abdominal strap of the seat belt should pass as low as possible across the pelvic area, resting flat and “surrounding” the abdomen >>> Fig. 24.
- Do not twist the seat belt while it is fastened.
- Once the seat belt is positioned correctly, don't pull it away from your body with your hand.
- Do not lie the seat belt across rigid or fragile objects, e.g. glasses, pens or keys.
- Never use seat belt clips, retaining rings or similar instruments to alter the position of the belt webbing.

i Note

If your physical constitution prevents you from maintaining the correct position of the belt webbing, contact a specialised workshop for help with any special devices to ensure the optimum protection of the seat belt and airbag. SEAT recommends taking your car in for technical service.

Automatic retractor, tensioner and belt force limiter

Vehicle seat belts are part of the vehicle's safety system >>> page 38. This system has the following important functions:

Automatic belt retractor

The seat belt shoulder straps on the driver's and front passenger seats, as well as those on the rear side seats (and, depending on equipment, also the seat belt of the central rear seat) are fitted with automatic retractors. This device ensures complete freedom of movement when the shoulder strap is pulled gently or during normal driving. However, during sudden braking, when driving in the mountains, around bends and when accelerating, the retractor locks the seat belt if it extends rapidly.

Seat belt tensioner

The seat belts on the front seats and, depending on the equipment, side rear seats are fitted with tensioners.

The tensioners are activated by sensors in the event of severe head-on, side and rear collisions, and tension the seat belts in a direction opposite their extension.

If the seat belt is slack, the tensioner tightens it. This cushions the forward movement of occupants towards the impact.

The belt pre-tensioners work in combination with the airbag system. If the vehicle overturns, the pre-tensioners do not activate unless the head airbags are deployed.

When activated, a fine powder may be released. This is completely normal and it is not an indication of fire in the vehicle.

⚠ WARNING

The seatbelt pre-tensioners are only activated once and the system must be replaced if they are triggered.

- Have any triggered pretensioners and affected parts of the system replaced immediately with new parts approved by SEAT for this vehicle.
- Repairs and modifications to the vehicle should only be made by qualified specialist workshops. They have the necessary di-

agnostic equipment, repair information and tools, as well as qualified personnel. SEAT recommends a SEAT dealership.

- Never fit belt pretensioner parts removed from vehicles at the end of their useful life, or pretensioners from recycling plants to the vehicle.
- Never modify any component of the belt pretensioners.

Belt force limiter

Depending on the equipment and the country in question, in the event of an accident, the seat belt force limiter reduces the force the seat belt exerts on the body.

Note

- After certain driving situations, the reversible belt tensioners may be left permanently tensioned¹⁾. In this case, to loosen the belt, it must be removed manually while the vehicle is stationary and then replaced correctly.
- The relevant safety requirements must be observed if the vehicle or any components of the system are to be scrapped. Specialised workshops are aware of these requirements.

¹⁾ Only if fitted with the PreCrash System.

Maintenance and disposal of seat belt tensioners

The belt tensioners are components of the seat belts that are installed in the seats of your vehicle. If you work on the belt tensioners or remove and install parts of the system when performing other repair work, the seat belt may be damaged. The consequence may be that, in the event of an accident, the belt tensioners function incorrectly or may not function at all.

Regulations, which are known to the specialised workshops, must be observed to ensure that the effectiveness of the seat belt tensioner is not reduced and that removed parts do not cause any injuries or environmental pollution.

WARNING

Improper handling and home repairs to seat belts, automatic retractors and belt tensioners may increase the risk of serious or fatal injuries. The tensioners may not activate, even though they should, or they may activate unexpectedly.

- Never repair, adjust, or disassemble and reassemble seat belt components or tensioners. Always have this work carried out by a specialist workshop.
- Seat belts, tensioners and their automatic retractors cannot be repaired and have to be replaced.

For the sake of the environment

Airbag modules and belt tensioners may contain perchlorate.

Observe the legal requirements for their disposal.

Airbag system

Why is it so important to wear a seat belt and to sit correctly?

For the inflating airbags to achieve the best protection, the seat belt must always be worn properly and the correct sitting position must be assumed.

The airbag system is not a substitute for seat belts, but it is an integral part of the vehicle's overall passive safety system. Please bear in mind that the airbag system can only work effectively when the vehicle occupants are wearing their seat belts correctly and have adjusted the headrests properly. Therefore, it is most important to properly wear the seat belts at all times, not only because this is required by law in most countries, but also for your safety »» page 40, *Seat belts*.

The airbag inflates in a matter of seconds, so if you are not properly seated when the airbag is triggered, you may sustain fatal injuries. Therefore, it is essential that all vehicle occupants assume a correct sitting position while travelling.

Sharp braking before an accident may cause a passenger not wearing a seat belt to be thrown forward into the area of the deploying airbag. In this case, the inflating airbag may inflict critical or fatal injuries on the occupant. This also applies to children.

Always maintain the greatest possible distance between yourself and the front airbag. This way, the front airbags can completely deploy when triggered, providing their maximum protection.

The most important factors for triggering the airbag are the type of accident, the angle of impact and the vehicle speed.

Whether or not the airbags are activated depends primarily on the vehicle deceleration rate resulting from the collision and detected by the control unit. If the vehicle deceleration occurring during the collision and measured by the control unit remains below the specified reference values, the front, side and/or curtain airbags will not be triggered. Take into account that the visible damage in a vehicle involved in an accident, no matter how serious, is not a factor that determines whether or not the airbags are activated.

WARNING


Wearing the seat belt incorrectly or assuming an incorrect sitting position can lead to critical or fatal injuries

- All vehicle occupants, including children, who are not properly strapped in can sustain critical or fatal injuries if the airbag is triggered. Children up to 12 years old should always travel on the rear seat. Never transport children in the vehicle if they are not restrained or the restraint system is not appropriate for their age, size or weight.
- To reduce the risk of injury from an inflating airbag, always wear the seat belt properly >>> page 40.

Description of the airbag system

The airbag system offers additional protection for the occupants in combination with the seat belts.


The airbag system comprises the following modules (as per vehicle equipment):

- Electronic control unit
- Front airbags for driver and passenger
- Side airbags
- Head airbag
- Airbag control lamp  on the instrument panel >>> page 48

- Key-operated switch for front passenger airbag

- Control lamp for disabled/enabled status of the front passenger airbag.

The airbag system operation is monitored electronically. The airbag control lamp will illuminate for a few seconds every time the ignition is switched on (self-diagnosis).

There is a fault in the system if the control lamp :

- does not light up when the ignition is switched on >>> page 48,
- turns off after 4 seconds after the ignition is switched on,
- turns off and then lights up again after the ignition is switched on,
- illuminates or flashes while the vehicle is moving.

The airbag system is not triggered if:

- the ignition is switched off
- there is a minor frontal collision
- there is a minor side collision
- there is a rear-end collision
- in the event of the vehicle overturning if the dynamic characteristics measured by the control unit are too low,
- the impact speed is lower than the reference value programmed in the control unit.

WARNING

- The seat belts and airbags can only provide maximum protection if the occupants are seated correctly >>> page 38.
- If a fault has occurred in the airbag system, have the system checked immediately by a specialised workshop. Otherwise there is a danger that during a collision, the system may fail to trigger, or not trigger correctly.

Airbag activation

The airbags deploy extremely rapidly, within thousandths of a second, to provide additional protection in the event of an accident. A fine dust may develop when the airbag deploys. This is normal and it is not an indication of fire in the vehicle.

The airbag system is only ready to function when the ignition is on.

In special accidents instances, several airbags may activate at the same time.

In the event of minor head-on and side collisions, rear-end collisions, overturning or rollover of the vehicle, airbags **do not activate**.

Activation factors

The conditions that lead to the airbag system activating in each situation cannot be generalised. Some factors play an important role, such as the properties of the object the vehicle hits (hard/soft), angle of impact, vehicle speed, etc.

Deceleration trajectory is key for airbag activation.

The control unit analyses the collision trajectory and activates the respective restraint system.

If the deceleration rate is below the predefined reference value in the control unit the airbags will not be triggered, even though the accident may cause extensive damage to the car.

The following airbags are triggered in serious head-on collisions:

- Driver airbag.
- Front passenger front airbag

The following airbags are triggered in serious side-on collisions:

- Curtain (head) airbag on the side of the accident.
- Front side airbag on the side of the accident.

In an accident with airbag activation:

- the interior lights switch on (if the interior light switch is in the courtesy light position);
- the hazard warning lights switch on;
- all doors are unlocked;
- the fuel supply to the engine is cut;
- an emergency call is started.

Airbag system control lamps**Lights up on the instrument cluster**

Fault in the airbag system and seat belt tensioners. Have the system checked immediately by a specialised workshop.

**Lights up on the dash panel**



Front passenger airbag deactivated. Check if the airbag should be kept deactivated.

OR: Fault in the airbag system. Have the system checked immediately by a specialised workshop.




**ON Lights up on the dash panel**

Front passenger airbag activated. The control lamp turns off automatically 60 seconds after the ignition is switched on.

Several warning and control lamps light up for a few seconds when the ignition is switched on, signalling that the function is being verified. They will switch off after a few seconds.

If the airbag and seat belt tensioner system control lamp  remains on or flashes, it indicates a malfunction in the airbag and seat belt tensioner system >>> . Have the system checked immediately by a specialised workshop.

If the front passenger airbag has been deactivated, the warning lamp **OFF**  remains lit in the middle of the dash panel to remind you that the airbag is deactivated. If, with the front passen-

ger airbag deactivated, this lamp **does not remain lit** or if it is lit along with the control lamp  on the instrument cluster, there is a fault in the airbag system >>> . If the control lamp is flashing, there is a fault in the disabling of the airbag system >>> . Have the system checked immediately by a specialised workshop.

WARNING

In the event of a fault in the airbag and seat belt tensioner system, the airbags and seat belts may not trigger correctly, may fail to trigger or may even trigger unexpectedly.

- The vehicle occupants run the risk of sustaining severe or fatal injuries. Have the system checked immediately by a specialised workshop.
- Do not mount a child seat in the front passenger seat or remove the mounted child seat! The front passenger airbag may deploy during an accident in spite of the fault.

NOTICE

Always pay attention to any lit control lamps and to the corresponding descriptions and instructions to avoid damage to the vehicle or harm to the occupants.

Front airbags

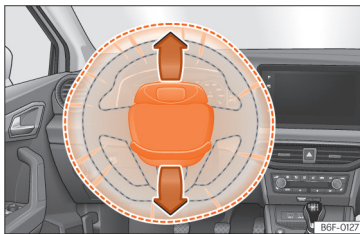


Fig. 25 Driver's airbag in the steering wheel.

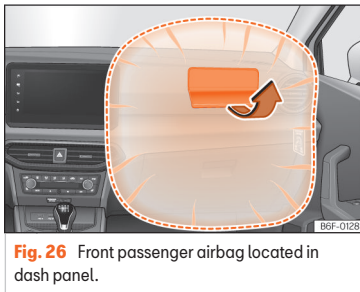



Fig. 26 Front passenger airbag located in dash panel.

The driver's front airbag is housed in the steering wheel and that of the front passenger, on the dash panel. Airbags are identified by the word "AIRBAG".

The airbag covers open and remain attached to the steering wheel and instrument panel when the driver and front passenger airbags are triggered, respectively >>> **Fig. 25**, >>> **Fig. 26**.

In conjunction with the seat belts, the front airbag system gives the front occupants additional protection for the head and chest in the event of a severe frontal collision >>> .

In addition, in certain head-on collisions, the head airbag is triggered on both sides of the vehicle.

Their special design allows the controlled escape of the propellant gas when an occupant puts pressure on the bag. Thus, the head and chest are protected by the airbag. After the collision, the airbag deflates sufficiently to allow visibility.

WARNING

- The deployment space between the front passengers and the airbags must not in any case be occupied by other passenger, pets and objects.
- The airbags provide protection for just one accident; replace them once they have deployed.
- It is also important not to attach any objects such as cup holders or telephone mountings to the surfaces covering the airbag units.

Activate and deactivate front passenger front airbag



Fig. 27 Switch for activating and deactivating the front passenger airbag.



Fig. 28 Centre of the instrument panel: control lamp for deactivated front passenger airbag in centre console.

Deactivate the front passenger front airbag only if you have to use a rear-facing child seat in the front passenger seat.

SEAT recommends fitting the child seat in the rear seat to avoid having to deactivate the front passenger airbag.

When the front passenger airbag is **deactivated**, this means that only the front passenger front airbag is deactivated. All the other airbags in the vehicle remain activated.

Deactivate and activate the front passenger front airbag

- Switch the ignition off.
- Open the passenger side door.
- Remove the key shaft from the vehicle key.
- Insert the key blade into the slot provided in the front passenger airbag disconnection switch >>> Fig. 27. About 3/4 of the key should enter; this is as far as it will go.
- Turn the key gently to change its position to **OFF** (deactivate) or to **ON** (activate). If you have difficulty, ensure that you have inserted the key as far as it will go.
- Close the front passenger door.
- When deactivating the airbag, switch the ignition on and check that the control lamp **OFF** remains lit >>> Fig. 28.
- When reactivating the airbag, check that when the ignition is switched on, the **OFF** control lamp does not light up and the **ON** lamp lights up for 60 seconds and then turns off.

⚠ WARNING

- The driver of the vehicle is responsible for disabling or switching on the airbag.
- Always switch off the ignition before disabling the front passenger airbag! Failure to do so could result in a fault in the airbag deactivation system.
- Never leave the key in the airbag disabling switch as it could get damaged or enable or disable the airbag during driving.
- If for any reason an airbag is deactivated, reactivate it as soon as possible so that it can fulfil its protective function.

Side airbags

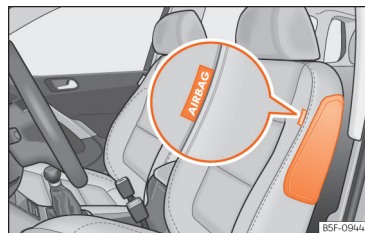


Fig. 29 Side airbag in driver's seat.

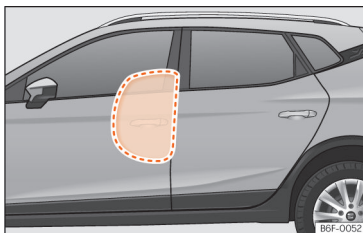


Fig. 30 Illustration of completely inflated side airbag on left side of vehicle.

The side airbags are located in the front seat backrests >>> Fig. 29 , >>> Fig. 30.

Its location is marked with the word "AIRBAG" on the upper part of the back of the seats or on the lower coverings with the word AIRBAG in relief.

In conjunction with the seat belts, the side airbag system provides additional protection for the upper body in the event of a severe side collision >>> ▲.

In a side collision, the side airbags reduce the risk of injury to passengers to the areas of the body facing the impact. In addition to their normal protection, the seat belts also hold the passengers in the event of a side collision; this is how these airbags provide maximum protection.

▲ WARNING

- If you do not wear a seat belt, if you lean forward, or are not seated correctly while the vehicle is in motion, you are at a greater risk of injury if the side airbag system is triggered in an accident.
- In order for the side airbags to provide their maximum protection, the prescribed sitting position must always be maintained with seat belts fastened while travelling.
- In a side-on collision the side airbags will not work if the sensors do not correctly measure the pressure increase on the interior of the doors, due to air escaping through the areas with holes or openings in the door panel.
- Never drive if the interior door panels have been removed or if the panels have not been correctly fitted.
- Occupants of the outer seats must never carry any objects or pets in the deployment space between them and the airbags, or allow children or other passengers to travel in this position. It is also important not to attach any accessories (such as cup holders) to the doors. This would impair the protection offered by the side airbags.
- Ensure that children are correctly seated in their seats and that their heads are not in the deployment zone of the side airbags >>> Fig. 30, as deploying airbags could hit them and cause serious injury.

- The built-in coat hooks should be used only for lightweight clothing. Do not leave any heavy or sharp-edged objects in the pockets.
- Great forces, such as hard blows or kicks, must not be exerted upon the backrest bolster because the system may be damaged. In this case, the side airbags would not be triggered.
- Under no circumstances should protective covers be fitted over seats with side airbags unless the covers have been approved for use in your vehicle. Because the airbag deploys from the side of the backrest, the use of conventional seat covers would obstruct the side airbag, seriously reducing the airbag's effectiveness.
- Any damage to the original seat upholstery or around the seams of the side airbag units must be repaired immediately by a specialised workshop.
- The airbags provide protection for just one accident; replace them once they have deployed.
- Any work on the side airbag system or removal and installation of the airbag components for other repairs (such as removal of the front seat) should only be performed by a specialised workshop. Otherwise, faults may occur during the airbag system operation.

Head-protection airbags

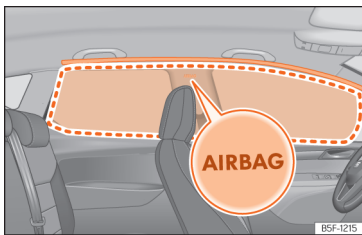


Fig. 31 Location and deployment area of the head-protection airbag.

Head-protection airbags are on both sides of the passenger compartment, above the doors >>> **Fig. 31** and their location is indicated with the word "AIRBAG".

In conjunction with the seat belts, the head-protection airbag system gives the vehicle occupants additional protection for the head and upper body in the event of a severe side collision >>> **△**.

The framed area is covered by the head-protection airbag when it is deployed (deployment area) >>> **Fig. 31**. Therefore, objects should never be placed or mounted in this area >>> **△**.

In the event of a side collision the curtain airbag is triggered on the impact side of the vehicle.

The head-protection airbags reduce the risk of injury to passengers in the front and rear side seats facing the impact.

△ WARNING

- In order for the head-protection airbags to provide their maximum protection, the prescribed sitting position must always be maintained with seat belts fastened while travelling.
- For safety reasons, the curtain airbag must be disabled in those vehicles fitted with a screen dividing the interior of the vehicle. See your technical service to make this adjustment.
- There must be no other persons, animals or objects between the occupants of the outer seats and the deployment space of the head-protection airbags so that the head-protection airbag can deploy completely without restriction and provide the greatest possible protection. Therefore, sun blinds which have not been expressly approved for use in your vehicle may not be attached to the side windows.
- Ensure that children are correctly seated in their seats and that their heads are not in the deployment zone of the head airbags >>> **Fig. 31**, as deploying airbags could hit them and cause serious injury.
- The built-in coat hooks should be used only for lightweight clothing. Do not leave any heavy or sharp-edged objects in the pockets. Please, do not hang the clothes on coat hangers.
- The airbags provide protection for just one accident; replace them once they have deployed.

- Any work on the head-protection airbag system or removal and installation of the airbag components for other repairs (such as removal of the roof lining) should only be performed by a specialised workshop. Otherwise, faults may occur during the airbag system operation.
- The side and head airbags are managed through sensors located in the interior of the front doors. To ensure the correct operation of the side and curtain airbags neither the doors nor the door panels should be modified in any way (e.g. fitting loudspeakers). If the front door is damaged, the airbag system may not work correctly. All work carried out on the front door must be done in a specialised workshop.

Transporting children safely

Introduction

For safety reasons, as we have learned from accident statistics, we recommend that children under 12 years of age travel in the rear seats. Depending on their age, height and weight, children travelling in rear seats must use a child seat or a seat belt. For safety reasons, the child seat should be installed in the rear seat, behind the front passenger seat or in the centre back seat.

The laws of physics involved and the forces acting in a collision apply also to children »» page 42. But unlike adults, children do not have fully developed muscle and bone structures. This means that children are subject to a greater risk of injury.

To reduce the risk of injuries, children must always use special child restraint systems when travelling in the vehicle.

We recommend the use of child safety products from the Genuine Accessories Programme, which includes systems for all ages (see www.seat.com).

These systems have been especially designed and approved and comply with the UN ECE R129 (i-Size) regulation.

- Rear-facing child seat (group 0+): ISOFIX and support leg (Britax Römer Baby-Safe 3 i-SIZE + Flex Base i-SENSE).
- Forward-facing child seat (group 1): ISOFIX AND Top Tether (Britax Römer TRIFIX 2 i-Size).
- Forward-facing child seat (group 2): seat belt and ISOFIX (Britax Römer KIDFIX i-Size). You must also use the seat's "Secure-Guard" seat-belt connection point and adjust the side impact protection system "SICT" (available on certain models), located in the seat backrest. Adjust only the "SICT" closest to the door. Please follow the child seat manufacturer's usage instructions.
- Forward-facing child seat (group 3): seat belt and ISOFIX (Britax Römer KIDFIX i-Size). Group 3 can use the seat with backrest or only the

seat base without the backrest (booster). The backrest of the child seat has an adult seat belt guide and a head restraint, meaning that the seat with the backrest offers better protection than boosters without backrests. SEAT recommends the use of child seats with backrests.

Follow the manufacturer's instructions and observe any statutory requirements when installing and using child seats. Always read and note »» page 54.

We recommend you always carry the manufacturer's Child Seat Instruction Manual together with the on-board documentation.

Child seats group classification



Fig. 3.2 Examples of child seats.

Use only child seats that are officially approved and suitable for the child.

These seats are subject to the ECE-R44 or ECE-R129 standards. ECE-R stands for: Economic Commission for Europe Regulation.

Child seats by weight group

The child seats are grouped into 5 categories:

Age group	Weight of the child
Group 0	Up to 10 kg
Group 0+	Up to 13 kg
Group 1	From 9 to 18 kg
Group 2	From 15 to 25 kg
Group 3	From 22 to 36 kg

Child seats that have been tested and approved under the ECE R44 or ECE-R129 standards bear the ECE-R44 or ECE-R129 test marks on the seat (the letter E in a circle with the test number below it).

Follow the manufacturer's instructions and observe any statutory requirements when installing and using child seats.

We recommend you to always include the manufacturer's Child Seat Instruction Manual together with the on-board documentation.

SEAT recommends you use child seats from the **Original Accessories Catalogue**. These child seats have been designed and tested for use in our vehicles. You can find the right child seat for your model and age group at our dealers.

Child seats by approval category

Child seats may have the approval category of universal, semi-universal, vehicle specific (all according to the ECE-R44 standard) or i-Size (according to the ECE-R129 standard).

- **Universal:** child seats with universal approval can be installed in all vehicles. There is no need to consult any list of models. In the case of universal approval for ISOFIX, the child seat is additionally provided with a Top Tether belt.
- **Semi-universal:** semi-universal approval, in addition to the standard requirements of universal approval, requires safety devices to lock the child seat, which require additional testing. Child seats with semi-universal approval include a list of vehicle models for which they can be installed.
- **Vehicle-specific:** vehicle-specific approval requires a dynamic test of the child seat for each vehicle model separately. Child seats with vehicle-specific approval also include a list of vehicle models for which they can be installed.
- **i-Size:** child seats with i-Size approval must meet the requirements prescribed in the ECE-R129 standard in relation to installation and

safety. Child seat manufacturers can tell you which seats have i-Size approval for this vehicle.

Fitting and using child seats



Fig. 33 Airbag sticker: on the passenger side sunshade blind.



Fig. 34 Airbag sticker: at the bottom of the passenger door frame.

Warnings about fitting a child seat


Take the following general warnings into account if you are going to fit a child seat. They are valid for all child seats regardless of their attachment system.

- Please read and follow the child seat manufacturer's operating instructions.
- The child seat should preferably be fitted to the rear seat behind the front passenger seat so that the child can exit the vehicle on the pavement side.
- Set the height of the seat belt such that it adapts to the child seat naturally, without twisting. The lowest position of the seat belt height regulator must be used with rear-facing child seats.
- To correctly use a child seat in the back, the front backrest must be adjusted so that there is no contact with the child seat in the back if it is rear facing. In the case of front facing restraint systems, the front backrest must be adjusted so that there is no contact with the child's feet.
- For a correct assembly of the child's seat on the rear seats, adjust or dismount the headrest, in order to prevent contact with the seat.
- If a semi-universal type seat is to be installed, in which the method of attachment to the car is through the seat belt and support bracket, it should never be installed in the central rear seat as the ground clearance is lower than in other places and the support bracket will not allow the seat to remain sufficiently stable.

Important information about the front passenger airbag

A sticker with important information about the passenger airbag is located on the passenger's sunshade blind and/or at the bottom of the passenger door frame »» Fig. 33, »» Fig. 34.

Read and always observe the safety information included in the following chapters:

- Safety distance with respect to the passenger airbag »» page 46.
- Objects between the passenger and the passenger side airbag »»  in *Front airbags* on page 49.

The passenger side front airbag, when enabled, is a serious risk for a rear-facing child since the airbag can strike the seat with such force that it can cause serious or fatal injuries. Children up to 12 years old should always travel on the rear seat.

Therefore we strongly recommend that you transport children on the rear seats. This is the safest location in the vehicle. Alternatively, the front passenger airbag can be disabled with a key-operated switch »» page 50. When transporting children, use a child seat suitable for the age and size of each child »» page 53.

WARNING

- If a child seat is secured to the front passenger seat, the risk to the child of sustaining critical or fatal injuries in the event of an accident increases.
- An inflating front passenger airbag can strike the rear-facing child seat and throw it with great force against the door, the roof or the backrest.
- Never install a rear-facing child seat on the front passenger seat unless the front passenger airbag has been disabled. Risk of potentially fatal injuries to the child! However, if necessary, the front passenger airbag must be deactivated»» page 50.
- For those vehicles that do not include a key lock switch to deactivate the airbag, the vehicle must be taken to a technical service. Do not forget to reconnect the airbag when an adult wants to sit in the front passenger seat.
- Never allow a child to be transported in a vehicle without being properly secured, or to stand up or kneel on a seat while travelling. In an accident, the child could be flung through the vehicle, causing possibly fatal injuries to themselves and to the other vehicle occupants.
- Never leave a child alone in the child seat or in the vehicle.

- Children who are less than 1.50 m tall must not wear a normal seat belt without a child seat, as this could cause injuries to the abdominal and neck areas during a sudden braking manoeuvre or in an accident.
- When a child seat is mounted in the rear seats, the door's child lock should be activated »» page 77.

Attachment systems

Depending on the country, different attachment systems are used for safely installing child seats.

Attachment systems overview

- **ISOFIX:** ISOFIX is a standardised attachment system allowing quick and safe attachment of child seats in the vehicle. ISOFIX attachment establishes a rigid connection between the child seat and the car body.

The child seat has two rigid attachment clips, called connectors. These connectors are fitted into the ISOFIX attachment rings found between the seat cushion and the backrest of the vehicle's back seat (on the sides). ISOFIX attachment systems are used mainly in Europe »» page 56. If necessary, ISOFIX attachment may have to be supplemented with a Top Tether belt or a support bracket.

- **Automatic three-point seat belt.** Whenever possible, it is preferable to attach the child seats with the ISOFIX system rather than attaching them with an automatic three-point seat belt »» page 59.

Additional attachment:

- **Top Tether:** the Top Tether belt is guided over the back of the rear seat and attached to an anchor point with a hook. Anchor points are located at the back of the rear seat backrest on the luggage compartment side »» page 59. The rings for retaining the Top Tether belt are marked with an anchor symbol.
- **Support bracket:** some child seats rest on the floor of the vehicle with a support bracket. The support bracket prevents the child seat from tipping forward in the event of impact. Child seats fitted with a support bracket should only be used in the passenger seat and side rear seats »» ⚠. For the assembly of this type

of seat you should also consult the list of approved vehicles for this assembly, available in the instructions for child restraint systems.

Recommended systems for attaching child seats

SEAT recommends attaching child seats as follows:

- **Baby carriers or rear facing child seats:** ISOFIX and support bracket or i-Size.
- **Forward-facing child seats:** ISOFIX and Top Tether.

WARNING

Incorrect use of the support bracket can cause serious or fatal injury.

- **Make sure the support bracket is correctly and safely installed.**
- **When the child seat base is supporting the weight of the child, the support leg must not be in the air or propped up with objects. Also ensure that the base of the child seat rests permanently on the surface of the vehicle's seat. The support leg of the child seat must not lift the base of the child seat off the surface of the vehicle's seat.**

Securing the child seat with the ISO-FIX or i-Size system

The marking of ISOFIX or i-Size anchor points depends on the equipment and the country in question.

To understand the compatibility of the ISOFIX or i-Size systems in the vehicle, check the table below.

Vehicle ISOFIX/i-Size positions

Weight group	Child seat orientation	Size class / ISOFIX class	Front passenger seat		Rear side seat	Rear central seat
			airbag enabled	airbag disabled		
Group 0: up to 10 kg	Rear facing	E / R1	X	X	IL	X
Group 0+: up to 13 kg	Rear facing	E / R1	X	X	IL	X
		D / R2	X	X	IL	X
		C / R3	X	X	IL	X
		D / R2	X	X	IL	X
Group I: 9 to 18 kg	Rear facing	C / R3	X	X	IL	X
		B / F2	X	X	IL, IUF	X
	Forward-facing	B1 / F2X	X	X	IL, IUF	X
		A / F3	X	X	IL, IUF	X
Group II: 15 to 25 kg	Forward-facing	-- / --	X	X	IL	X
Group III: 22 to 36 kg	Forward-facing	-- / --	X	X	IL	X
i-Size child seat	Rear facing	-- / R2	X	X	IUF	X
	Forward-facing	-- / B2, F2X	X	X	IUF	X
Booster	Forward-facing	-- / B2, B3	X	X	IB	X

- Size class:** The indication of class according to size corresponds to the authorised body weight for the child seat. In child seats with universal or semi-universal approval, the class according to size is indicated on the ECE approval label. The indication of class according to size is stated on the corresponding child seat.
- IUF:** Suitable for forward-facing ISOFIX / i-Size “universal” child restraint systems approved for use in this weight group.
- IL:** It is suitable for certain ISOFIX child restraint systems that can be for the specific vehicle, restricted or semi-universal categories. Take the child seat manufacturer's vehicle list into account.
- IB:** Seat suitable for installing an ISOFIX forward-facing group 2/3 booster seat as well as an i-size forward-facing child seat for children with a height of 100 to 150 cm.

- **X:** Position not suitable for ISOFIX or i-Size child restraint systems in this weight group or size class.

Securing the child seat with the ISOFIX or i-Size system

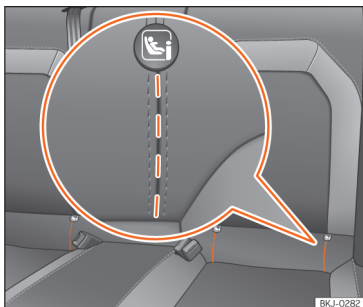


Fig. 35 Rear seat: slots pre-punched to access the ISOFIX / iSize securing rings.

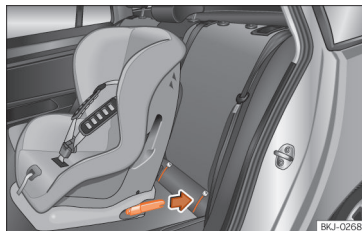


Fig. 36 Rear seats: fitting a child seat with the ISOFIX system.

You must follow the child seat manufacturer's instructions.

The location of the ISOFIX or i-Size anchor point is indicated by a symbol »» **Fig. 35**. In some vehicles, the rings are secured to the seat frame and, in others, they are secured to the rear floor.

- First open the cut-out section behind the marked grooves to access the securing rings »» **Fig. 35**.
- Press the child seat onto the ISOFIX or iSize securing rings until it is heard to engage securely »» **Fig. 36**. If the child seat is equipped with Top Tether anchor points, secure it to the correspondent ring »» **page 59**. Follow the child seat manufacturer's instructions.
- Pull on both sides of the child seat to ensure that it is properly anchored.

Child seats with the ISOFIX or i-Size and Top Tether attachment system can be purchased from technical services.

⚠ WARNING

The securing rings are designed only for use with ISOFIX or i-Size and Top Tether system child seats.

- Never secure other child seats that do not have ISOFIX, i-Size or Top Tether systems, or safety belts or any other objects to the securing rings – as this can result in potentially fatal injuries to the child.
- Ensure that the child seat is correctly secured to the ISOFIX or i-Size rings and the Top Tether.

Top Tether securing belts

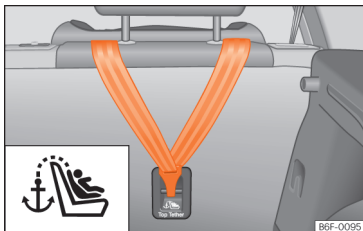



Fig. 37 Rear part of the rear seats: securing rings for the Top Tether belt.

Child seats with a Top Tether system are fitted with an additional belt for fastening to an anchor point in the vehicle. This anchor point is located on the rear of the rear seat backrest (identified with the symbol ) and provides better retention >>> **Fig. 37**.

The objective of this system is to reduce forward movements of the child seat in a head-on collision, to reduce the risk of injuries that may be caused to the child's head by impacting against any element of the inside of the vehicle.

Use of Top Tether on rear-facing child restraints

Currently, there are very few rear-facing child restraints with Top Tether. The car seat manufacturer's instructions for proper installation of the Top Tether should be read carefully and followed.

Locking the tether belt

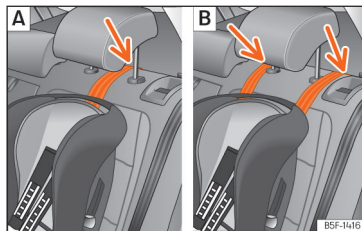


Fig. 38 Rear seats: adjustment and assembly according to the Top Tether belt.

- Deploy the Top Tether belt according to the child seat manufacturer's instructions.
- Position the belt under the headrest (according to the instructions of the seat itself, lift or remove the headrest if necessary) >>> **Fig. 38**.
- Slide the belt and secure it properly with the anchor on the rear seat backrest >>> **Fig. 37**.
- Tighten the belt securely according to the manufacturer's instructions.

Release the tether belt

- Loosen the belt according to the manufacturer's instructions.
- Press the lock and release it from the anchor bracket.

WARNING

Installing safety seats incorrectly will increase the risk of injury in the event of a collision.

- Never attach the tether belt to a fastening hook in the luggage compartment.
- Never attach or secure luggage or other items to the lower anchor points (ISOFIX) or Top Tether anchor points.

WARNING

Child restraint anchors are designed to support the loads of properly adjusted child restraint systems. Under no circumstances should they be used to attach adult seat belts, harnesses or other items or equipment to the vehicle.

Fitting a child seat using the seat belt

If you want to fit a universal approval category (U) child seat in your vehicle, you must check that the seat is approved for your vehicle.

You will find any necessary information on the child seat's orange ECE approval label.

The following table shows the different fitting options.

Weight group	Front passenger seat ^{a)}		Rear side seat	Rear central seat ^{b)}
	Airbag enabled ^{c)}	Airbag deactivated ^{c)}		
Group 0 up to 10 kg	X	U	U	U
Group 0+ up to 13 kg	X	U	U	U
Group I 9 to 18 kg	Rear-facing	X	U	U
	Forward-facing	U	X	U
Group II 15 to 25 kg	U	X	U	U
Group III 22 to 36 kg	U	X	U	U

X: Not compatible for the installation of seats install chairs in this configuration.

U: Suitable for universal restraint systems for use in this weight group.

^{a)} Compliance with current national legislation and the manufacturer's instructions is required when using or installing child seats.

^{b)} For semi-universal chairs where the securing system is the car safety belt and the support bracket, do not use them in the centre rear seat.

^{c)} Seats **without** height adjustment should be placed in their rearmost position. Seats **with** height adjustment should be placed in their rearmost and highest position.

Fitting a child seat using the seat belt

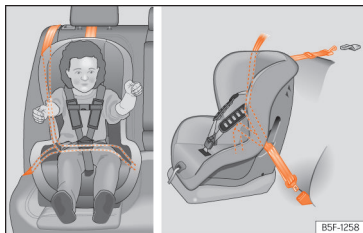


Fig. 39 On rear seats: installing a child seat.

- Put the seat belt in place and pass it through the child seat according to the instructions of the child seat manufacturer.
- Make sure that the seat belt is not twisted.
- Insert the latch plate into the seat's buckle until you hear the engagement click.

⚠ WARNING

When travelling, children must be secured in the vehicle with a restraint system suitable for age, weight and size.

- Always read and observe information and warnings concerning the use of child seats >>> page 54.

Fitting a child seat to the middle seat of the rear bench using the seat belt

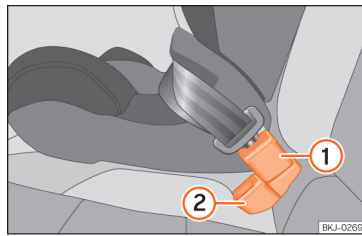


Fig. 40 Position of the belt buckle on the rear seat

- ① Belt buckle for the middle seat
 - ② Belt buckle for the side seat
- Child seats must always be fitted in the middle of a vehicle seat. Take into account these instructions to ensure that this is possible on the middle seat of the rear bench:
- Place the middle seat's belt buckle >>> Fig. 40 ① behind the side seat's belt buckle >>> Fig. 40 ②.
 - Plug the middle seat's seat belt into the middle seat's belt buckle >>> Fig. 40 ① and make sure it clicks in place.
 - For seat belts to be correctly fitted, the buckles must not be twisted >>> Fig. 40.

In case of emergency

Hazard warning lights



Fig. 41 Dashboard: switch for hazard warning lights.

The hazard warning lights are used to draw the attention of other road users to your vehicle in emergencies.

If your vehicle is stationary:

1. Park the vehicle at a safe distance from road traffic.
2. Press the button to switch on the hazard warning lights >>> ⚠.
3. Stop the engine.
4. Apply the parking brake.
5. Engage 1st gear in vehicles with a manual gearbox, or set the gear selector to the **P** position in vehicles with automatic transmission.

- Follow the legal provisions of each country (reflective vest, warning triangles, light beacon, etc.).
- Always carry the key with you when leaving the vehicle.

All turn signals flash simultaneously when the hazard warning lights are switched on. The two turn signal turn signal lamps $\blacktriangleleft\blacktriangleright$ and the turn signal lamp in the switch \triangle will flash at the same time. The simultaneous hazard warning lights also work when the ignition is switched off.

While the hazard warning lights are on, you can signal a direction or lane change, e.g. during towing, by operating the turn signal lever. The hazard warning lights remain switched off during this time.

Emergency braking warning

If the vehicle brakes suddenly and continuously at a speed of more than 80 km/h (50 mph), the brake light flashes several times per second to warn the vehicles driving behind. If you continue braking, the hazard warning lights will come on automatically when the vehicle comes to a standstill. They switch off automatically when the vehicle starts to move again.

WARNING

- The risk of an accident increases if your vehicle breaks down. Always use the hazard warning lights and a warning triangle (or light beacon, depending on the country) to draw the attention of other road users to your stationary vehicle.
- Never leave anybody inside the vehicle, particularly children or anybody who may need help. This is especially important when the doors are locked. Individuals locked in the vehicle can be exposed to very high or very low temperatures.
- Due to the high temperatures that the catalytic converter can reach, never park in an area where the catalytic converter could come into contact with highly inflammable materials, for example dry grass or spilt petrol. This could start a fire.

Note

- The 12-volt vehicle battery will run down if the hazard warning lights are left on for a long time (even if the ignition is switched off).
- The use of the hazard warning lights described here is subject to the relevant statutory requirements.

Behaviour in the event of an accident or fire

Actions to take in the event of a fire or accident

For your own safety and that of other passengers, the following points should be observed in the order given \ggg \triangle :

- Switch off the engine.
- If possible, switch on the hazard warning lights \ggg page 61.
- Follow the legal provisions of each country (reflective vest, warning triangles, light beacon, etc.).
- If necessary, get any people out of the hazard area and apply first aid.
- Notify the emergency services.
- Wait at a safe distance from the scene of the accident for the emergency services to arrive.
- In case of fire, do not attempt to extinguish the fire yourself or remain near the vehicle.

WARNING

For your own safety, do not ignore this important check list, otherwise accidents and serious injuries could occur.

- Always complete the operations on the check list and always bear in mind the general safety measures.

WARNING

In the event of fire, an explosion may occur and substances harmful to health may be released, which can cause serious injury.

- Never stay near the burning vehicle.

Information call, Assistance call and Emergency call service

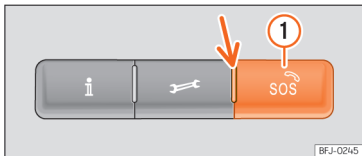


Fig. 4.2 On the roof console: controls for voice services

Depending on the equipment, an emergency call system may be located on the roof console.

The following voice services can be run by pressing the buttons **i**, **🔧** and **SOS** >>> **Fig. 4.2:**

- Information call.
- Assistance call.
- Emergency call service.

A built-in control unit establishes the connection.

When a voice service is activated, a connection is established with a phone line.

Control lamp.

There is a control lamp on the control >>> **Fig. 4.2** (arrow). It shows the following statuses:

- **Off:** the eCall service is not available.
- **Flashes in red, approx. 20 seconds after switching on the ignition:** the eCall service is deactivated.
- **Lights up red:** system failure. The eCall service is available with certain restrictions. SEAT suggests going to a specialised workshop.
- **Lights up green:** the eCall service is available. The system is ready to work in the vehicle.
- **Flashes green:** There is an ongoing voice connection.

🔧 Assistance call

With the breakdown call you can directly request specialised help in the event of a breakdown.

Parallel to the voice call, some vehicle data is transmitted, e.g. your current location.

i Information call

With an information call, a call is placed to the customer care service of SEAT. S.A.

Note

Breakdown service and information calls can incur an additional cost on your telephone bill.

SOS Types of emergency call

- **Public** (mandatory by law): emergency call made to the emergency services of the country you are driving in, in the language of that country. >>> **page 65.**
- **Private:** an emergency call that is made to a "SEAT call centre", which offers enhanced user service, such as service in the language selected in the infotainment system. At any time, the user can choose to cancel the *private emergency call* in order to be attended by the country's emergency services.

Private emergency call

If the private emergency call service is available in the vehicle's service portfolio, the emergency call service is activated by default for a limited period of time.

- The emergency call service can be used to organise help as quickly as possible in an emergency situation.
- When the emergency call service is activated, a connection is made to the SEAT emergency call centre.

- If an emergency call is made manually or, in the event of an accident, when the airbag or seatbelt pretensioner is triggered, the data relevant to the emergency call will be transmitted automatically, for example, the current location of the vehicle »» page 312.
- The telephone contact person communicates in the language set in the vehicle's Infotainment system. If this language is not available at the location where the emergency call is currently being made, English will be used.
- Additional components such as emergency call microphone, an emergency loudspeaker and an integrated battery which is separate from the integrated power supply, are installed to ensure operation even after a serious accident.
- The emergency call service can be deactivated permanently by a qualified specialist. SEAT recommends visiting a SEAT dealership.
- If the public emergency call system is available in the vehicle, the private emergency call service can be deactivated via the web or app, or by preventing data transmission in the Infotainment system, via the privacy mode »» page 189.

Starting an emergency call manually

1. Press and hold the emergency call button for a few seconds »» Fig. 42 ①.

The emergency call is activated and a voice connection is established with the emergency coordination centre.

The emergency call can also be activated manually via the Infotainment system

»» page 221.

If you press the emergency call button inadvertently, hang up the call immediately:

1. Press the emergency call button again until the control light stays green.

Note

Only press the emergency call button in the event of an emergency.

Automatic activation of an emergency call

The automatic emergency call is only activated if the ignition is switched on.

The connection to the SEAT emergency centre is automatically established in the following situations:

- Immediately after the airbags are triggered.
- Immediately after activation of the seatbelt pretensioner.

The automatic emergency call cannot be interrupted by pressing the emergency call button.

If enquiries from the SEAT emergency call centre remain unanswered, rescue measures are dispatched automatically.

Integrated battery

The integrated battery ensures that the emergency call system remains available for some time even if the 12-volt battery has been disconnected or has failed.

If the integrated battery discharges or is defective, a message stating this is displayed on the instrument cluster display. Go to a specialised workshop and ask for the battery to be replaced.

EDR data transmission »» page 312

When an emergency call is made, the available data are transmitted to the SEAT emergency call centre so that the necessary rescue measures can be determined.

Vehicle location data is continuously overwritten. This means that the vehicle is not subject to permanent monitoring.

The data related to the emergency call is only processed to ensure the correct operation of the emergency call system (eCall). The system will automatically delete the data related to the call a few hours after the call is activated.

The sent data includes:

- The vehicle's current position at the time the emergency call is activated.
- Vehicle identification number (VIN)
- Type of vehicle and type of drive.
- Type of activation (automatic or manual).
- Type of call.

- Direction in which the vehicle was travelling at the time the emergency call was activated.
- Moment of the collision.
- Estimated number of vehicle occupants.
- Language selected in the infotainment system.

WARNING

The following conditions may mean that it is not possible to make a public or private emergency call, either manually or automatically, or that it is only possible to a limited extent:

- The emergency call is made in an area with little or no mobile or GPS coverage.
- In areas with sufficient mobile and GPS signal reception, the mobile network of the telecommunication providers is not available. In this case, the emergency call, if available in the vehicle, uses the legally required emergency call system.
- In areas with sufficient mobile and satellite signal reception, a 2G/3G mobile telecommunication provider network is not available.
- In some countries, the emergency call service may not be available and depending on the location of the vehicle, the control lamp LEDs, and even the operation of the different types of calls, could behave in a specific way.
- There is no valid licence for the use of the emergency call service.

- The components of the vehicle required for the emergency phone call are damaged or do not get enough power.
- The emergency call service function has been deactivated via the web or the App. In this case, the emergency call, if available in the vehicle, is forwarded to the public emergency call service automatically.
- The emergency call service function has been deactivated by preventing the transmission of data (privacy mode). In this case, the emergency call, if available in the vehicle, calls the public emergency call system. If the private emergency call system cannot be executed for technical reasons, calls are forwarded to the public emergency call service automatically.
- The vehicle's ignition is not on.

Note

The operation of the emergency call system, which is required by law, may be limited if an infotainment system is retrofitted

Note

The emergency call, breakdown call and information service are only available in certain countries.

Note

Depending on the version, due to the shutdown of 2G/3G networks, there may be a delay in connecting the call to the emergency centre.

eCall emergency call service, required by law.

Depending on the equipment and the country, the vehicle may be fitted with an emergency call system. In some countries, the free public emergency call system is activated by default. The control element is located on the roof console »» Fig. 42.

With the emergency call, help can be organised as quickly as possible in emergency situations. A voice connection is established with a public rescue coordination centre. The telephone contact person communicates in the language of the country in which the vehicle is located. In addition, any legally required data relevant to emergency calls is automatically transmitted to the public rescue control centre, such as the vehicle's current location.

The required connection is made via a factory-installed control unit. Additional components such as an emergency call microphone, an emergency loudspeaker and an integrated battery which is independent of the integrated power supply, are required to ensure operation even after a serious accident.

Opening and closing

Set of vehicle keys

Vehicle key

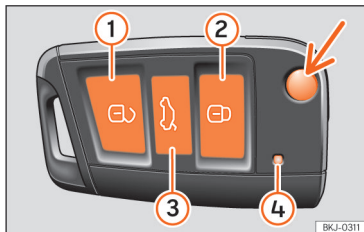


Fig. 43 Vehicle key



Fig. 44 Vehicle key with alarm button.

- ① Unlocks the vehicle.
- ② Locks the vehicle.

- ③ Unlocks only the rear lid.
Press the button until all the turn signals on the vehicle flash briefly.
You have 2 minutes to open the rear lid.
Once this time has passed, it will lock again. In addition, the lamp on the key flashes.
- ④ Control lamp.
- ⑤ Alarm button. Only press in the event of an emergency! When the alarm button is pressed, the vehicle's horn sounds and the turn signals light up for a short time. Press again to disconnect.

To fold and unfold the key blade, press the button »» Fig. 43 (arrow).

The vehicle can be locked and unlocked from a distance using the vehicle key »» page 71.

The vehicle key includes an emitter and battery. The receiver is in the interior of the vehicle. The range of the vehicle key with remote control and new battery is several metres around the vehicle.

If it is not possible to open or close the vehicle using the remote control key, this should be re-synchronised »» page 68 or the battery changed »» page 67.

Different keys belonging to the vehicle may be used.

Control lamp on the vehicle key

When a button is pressed briefly on the vehicle key, the control lamp (④) »» Fig. 43 flashes once briefly, but if pressed for a long period of time, it will flash several times, for example, when using the comfort opening.

If the vehicle key control lamp does not light up when the button is pressed, replace the key's battery »» page 67.

Spare key

To obtain a spare key and other vehicle keys, the vehicle chassis number is required.

Each new key contains a microchip which must be coded with the data from the vehicle's electronic immobiliser. A vehicle key will not work if it does not contain a microchip or the microchip has not been encoded. This is also true for keys which are specially cut for the vehicle.

The vehicle keys or new spare keys can be obtained from a SEAT Official Service, a specialised workshop or an approved key service qualified to create this kind of key.

New keys or spare keys must be synchronised before use »» page 68.

⚠ WARNING

- Never leave children or disabled persons in the vehicle. In case of emergency, they may not be able to leave the vehicle or manage on their own.
- An uncontrolled use of the key by third parties could activate a piece of electrical equipment (e.g. power windows), with the resulting accident hazard. The vehicle doors can be locked with the remote control key, making it difficult to get help in an emergency.
- Never leave the keys inside the vehicle. An unauthorised use of your vehicle could result in injury, damage or theft. Therefore always take the key with you when you leave the vehicle.
- Never remove the key from the ignition if the vehicle is in motion. Otherwise, the steering could suddenly block and it would be impossible to steer the vehicle.

ⓘ NOTICE

Do not leave the key near the *Wireless Charger* area as this may cause interference.

ⓘ NOTICE

All of the vehicle keys contain electronic components. Protect them from damage, impacts and humidity.

ⓘ Note

- Only use the key button when you require the corresponding function. Pushing the button unnecessarily could accidentally unlock the vehicle or trigger the alarm. It is also possible even when you are outside the radius of action.
- Key operation can be greatly influenced by overlapping radio signals close to the vehicle working in the same range of frequencies, for example, radio transmitters or mobile telephones.
- Obstacles between the remote control and the vehicle, bad weather conditions and discharged batteries can considerably reduce the range of the remote control.
- If the buttons of the vehicle key are pressed or one of the central locking buttons >>> page 72 is pressed repeatedly in short succession, the central locking briefly disconnects as protection against overloading. The vehicle is then unlocked. Lock it if necessary.
- Spare remote control keys are available at your Technical Service, where they must be matched to the locking system.

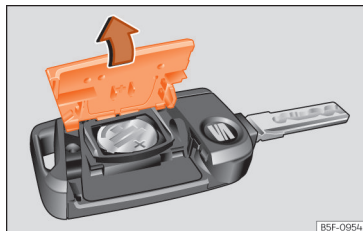
Changing the battery

Fig. 45 Vehicle key: opening the battery compartment.

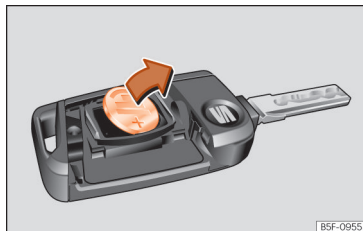


Fig. 46 Vehicle key: removing the battery.

SEAT recommends you ask a specialised workshop to replace the battery.

The battery is located at the back of the vehicle key, under a cover.

Changing the battery

- Unfold the vehicle key blade.
- Remove the cover from the back of the vehicle key in the direction of the arrow »» Fig. 45, »» ①.
- Remove the battery from the compartment with a suitable thin object »» Fig. 46.
- Fit a new button battery into the compartment »» ①.
- Press the cover onto the key housing until it clicks into place.

⚠ WARNING

Swallowing a battery with a diameter of 20 mm or any other button battery can cause serious injuries or even death within a very short time.

- Keep the vehicle key and key fobs with batteries out of reach of children.
- If you suspect that someone may have swallowed a battery, seek medical attention immediately.


ⓘ NOTICE


- If the battery is not changed correctly, the vehicle key may be damaged.
- Use of unsuitable batteries may damage the vehicle key. For this reason, always replace the dead battery with another of the same voltage, size and specifications.
- When fitting the battery, check that the polarity is correct.

♻ For the sake of the environment

Please dispose of your used batteries correctly and with respect for the environment.

Synchronize the vehicle key

If the  button is pressed frequently outside of the vehicle range, it is possible that the vehicle can no longer be locked or unlocked using the key. In this case, the key must be resynchronised as described below:

- Unfold the vehicle key blade »» page 66 .
- If necessary, remove the cover from the driver's door handle »» page 76.
- Press the  button on the vehicle key. Keep it inside the vehicle while doing this.
- Open the vehicle within one minute using the key blade. The key has been synchronised.
- If necessary, fit the cap.

Keyless Access system

Locking and unlocking with the Keyless Access system

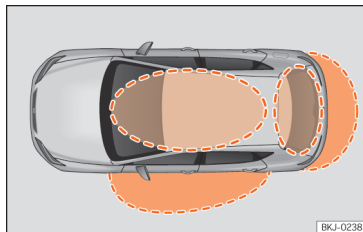


Fig. 47 Keyless Access: proximity zones.

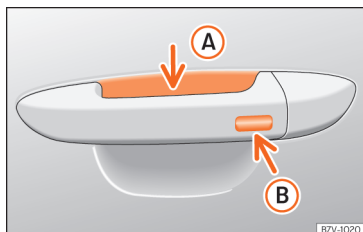


Fig. 48 Door handle: sensor surfaces.

»» Fig. 48

- Ⓐ Unlocking sensor surface on the inside of the door handle.

- Ⓑ Locking sensing surface on the outside of the door handle.

Depending on the equipment, the vehicle may have the Keyless Access system. This is a keyless locking and starting system that can unlock and lock the vehicle without actively using its key. For this, it is only necessary that there is a valid vehicle key in the detection area corresponding to the attempted access to the vehicle.

Unlocks the vehicle.

- Touch the sensor surface on the inside of the handle Ⓐ. All turn signals flash twice.

If selective opening is fitted, touching the sensor's surface twice unlocks the entire vehicle.

If the vehicle is not unlocked for an extended period, the function is deactivated. The function will reactivate the next time that the vehicle is unlocked with the remote control.

Locks the vehicle.

- Park the vehicle.
- Touch the sensor surface Ⓑ >>> Fig. 48 on the outside of the door handle. All turn signals flash once.


To check that the vehicle is properly locked, the unlocking function is deactivated for a few seconds.

Unlocking the rear lid

When the vehicle is locked, the rear lid automatically unlocks when it is opened if there is a vehicle key in its proximity zone. The rear lid locks again after closing.

Temporarily deactivating the Keyless Access system


The "Keyless Access" system's unlocking function can be temporarily deactivated:

- Move the gear lever to position **P** since otherwise the vehicle cannot be locked.
- Lock the vehicle using the  button on the vehicle key.
- Within 5 seconds, touch the sensor on the outside of the door handle once >>> Fig. 48 Ⓑ. Do not grip the handle while doing so. This temporarily deactivates the Keyless Access system.
- Check that it is deactivated by pulling on the door handle after at least 10 seconds. It should not be possible to open the door.

The next time, the vehicle can only be unlocked electronically with the vehicle key. After being unlocked the next time, the Keyless Access system will be activated again.

Comfort functions

To close all the electric windows using the comfort function, keep a finger on the locking sensor surface >>> Fig. 48 Ⓑ (arrow) of the door handle for a few seconds until the windows have closed.

How the **doors open** when touching the sensor surface on the door handle will depend on the settings that have been activated in the infotainment system, using the button  > **Settings** > **Opening and closing**.

Troubleshooting

The Keyless Access system does not work

The operation of the sensor surfaces may be limited if they are soiled.

- Clean the sensor surfaces.

All turn signals flash four times

The key that was last used is still inside the vehicle.


- Remove the key and lock the vehicle.

Automatic deactivation of the sensor surfaces

The sensor surfaces are deactivated in the following cases:

- If the vehicle is not unlocked or locked for a long period of time.
- If any of the sensor surfaces are activated unusually often.

To reactivate the sensor surfaces:

- Unlock the vehicle using the  button on the vehicle key.

NOTICE

The sensor surfaces on the door handles may activate if hit by a jet of water or high pressure steam if there is a valid vehicle key in the proximity area.

Note

If the message Keyless system faulty is displayed on the instrument cluster display, abnormalities may occur in the operation of the Keyless Access system. Contact a specialised workshop.

Note

If there is no vehicle key inside the vehicle or the system fails to detect one, a warning will display on the instrument cluster screen. This could happen if another radio frequency signal (e.g. mobile phone or wireless charger)... interferes with the key signal or if the key is covered by another object, e.g. a metal case

Central locking

Introduction

Central locking functions correctly when all the doors and the rear lid are correctly shut. If the driver's door is open, the vehicle cannot be locked with the key.

WARNING

The incorrect use of the central locking system may cause serious injuries.

- The central locking system will lock all doors. A vehicle locked from the inside can prevent any non-authorised individual from opening the doors and accessing the vehicle. Nevertheless, in case of emergency or accident, locked doors will complicate access to the vehicle interior to help the passengers.
- Never leave children or disabled people alone in the vehicle. The central locking button can be used to lock all the doors from within. Therefore, passengers will be locked inside the vehicle. Individuals locked in the vehicle can be exposed to very high or very low temperatures.
- Depending on the time of the year, temperatures inside a locked and closed vehicle can be extremely high or extremely low, resulting in serious injuries and illness or even death, particularly for young children.

- Never leave individuals locked in a closed and locked vehicle. In case of emergency, they may not be able to exit the vehicle by themselves or get help.

Description

Central locking allows all doors, the rear lid and the tank flap to be unlocked centrally:


- From outside, using the vehicle key
»» page 71.
- From outside with the Keyless Access system
»» page 68.
- From inside, by pushing the central locking button »» page 72.

Self-locking system to prevent involuntary unlocking

It is an anti-theft system and prevents the unintentional unlocking of the vehicle. If the vehicle is unlocked and none of the doors (including the boot) are opened within 45 seconds, it relocks automatically.

Automatic locking (Auto Lock)

The vehicle locks automatically at over a speed of approx. 15 km/h (9 mph). The fuel tank flap is unlocked so that you can refuel without getting out of the vehicle.

When the vehicle is locked, the control lamp  of the central locking button lights up yellow.

Automatic unlocking (Auto Unlock)

If one of the following conditions is met, all doors and the rear lid are unlocked automatically:

- With the vehicle stopped, the ignition is switched off or the ignition key is removed (depending on equipment).
- **EITHER:** the inside door handle has been pulled. This applies when driving at under 15 km/h (9 mph).
- **OR:** in the event of an accident and an airbag has been triggered >>> **page 73.**

Automatic unlocking allows third parties to access the interior of the vehicle to provide assistance if necessary.

Turn signals

The turn signals will flash twice when the vehicle is unlocked and once when the vehicle is locked.

If it does not flash, this indicates that one of the doors, the rear lid or the bonnet is not closed correctly.

Accidental lock-out

If you have left the key in the vehicle, it cannot be locked in the following cases:


- If the driver door is open, the vehicle cannot be locked with the central locking switch >>> **page 72.**

Lock the vehicle with the remote control key, when all the doors and the rear lid have been closed. This prevents the accidental locking of the vehicle.

Central locking settings


Central locking settings can be changed in the Infotainment system.


Selective unlocking of the doors

- Press the function button  > **Settings > Opening and closing > Central locking > Door unlocking.**

You can decide whether unlocking unlocks **all** doors, **one door** or **one side** of the vehicle.

In all the options, the fuel tank flap is also unlocked.

With the **One door** setting, when you press the  button on the remote control key once, only the driver door is unlocked. If that button is pressed twice, the rest of the doors and the rear lid will be unlocked.

If the  button is pressed, all the vehicle doors are locked. A confirmation signal will sound simultaneously (depending on the version).

Note

- **Never leave any valuable items in the vehicle unattended. Not even a locked vehicle is a safe.**
- **If the LED on the driver door sill lights up for about 30 seconds when the vehicle is locked, the central locking system or anti-theft alarm is not working properly. You should have the fault repaired at a SEAT Official Service or specialised workshop.**
- **The anti-theft alarm system's interior monitoring only works perfectly if the windows are closed.**

Unlock and lock with the key

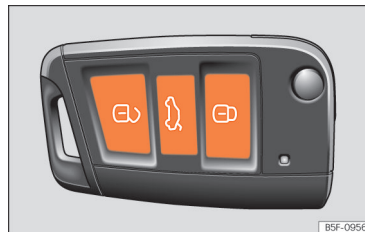







Fig. 49 Remote control key: keys.

- Lock: press the  button >>> **Fig. 49.**
- Locking the vehicle without the "Safe" security system: push the  button again and hold for 2 seconds.


- Unlock: press the  button.
- Unlocking the rear lid: hold down the  button for at least 1 second.

The vehicle will be locked again automatically if you do not open one of the doors or the rear lid within 45 seconds after unlocking the car. This function prevents the vehicle from remaining unlocked if the unlocking button is pressed by mistake. This does not apply if you press the  button for at least one second.


Selective unlocking system

The selective unlocking system allows you to only unlock the driver door and the fuel tank flap. All other doors and the rear lid remain locked.

Unlocking the driver's door and tank flap:

- Press (once) the  button on the remote control key or turn the key once in the opening direction.

Unlocking all the doors, the rear lid and the tank flap simultaneously:

- Within 5 seconds, press (twice) the  button on the remote control key, or turn the key twice within 5 seconds in the opening direction.

In vehicles with Infotainment system, you can programme the security central locking system directly **>>> page 70**.

WARNING

Observe the safety warnings **>>> page 73, Safe security system**.



Note

- For safety reasons it is advisable to only activate the remote control key when you can see the vehicle.
- Other functions of the remote control key **>>> page 79, Opening and closing the windows**.

Unlocking and locking from the inside



Fig. 50 Centre console: central locking switch.

- Lock: press the  button **>>> Fig. 50**.
- Unlock: Press the  button **>>> Fig. 50** again.


Please note the following when using the central locking switch to lock your vehicle:

- It is not possible to open the doors or the rear lid from the *outside* (for safety reasons, e.g. when stopped at traffic lights).
- The central locking button lamp lights up when all the doors are closed and locked.
- You can open the doors individually from the inside by pulling the inside door handle.
- The fuel tank flap is locked.
- In the event of an accident in which the air-bags inflate, doors locked from the inside will be automatically unlocked to facilitate access and assistance.

WARNING


- The central locking button also works with the ignition switched off, except when the "Safe" security system is activated.
- The central locking button does not operate if the vehicle is locked from the outside and the security system is switched on.
- Locked doors could delay assistance in an emergency. Do not leave anyone, especially children, in the vehicle.

Note

Your vehicle will lock automatically when it reaches a speed of approximately 15 km/h (9 mph) (Auto Lock) >>> page 70. You can unlock the vehicle again using the  key of the central locking button.

“Safe” security system


Depending on its equipment, the vehicle may be fitted with the “Safe” security system.

When the vehicle is locked, the “Safe” security system puts the door handles out of operation and hinders possible attempts by people to access the vehicle. The doors cannot be opened from inside >>> .

The instrument cluster may display an indication that the “Safe” security system is switched on.

Disabling the “Safe” security system

The “Safe” security system may be disabled in any of the following ways:

- Press the vehicle key button  again **within 2 seconds**.
- Touch the sensor surface on the outside of the door handle again **within 2 seconds** >>> page 68.
- Switch the ignition on.
- **OR:** deactivate interior monitoring and the anti-tow system >>> page 75.

Depending on the equipment, before locking the vehicle temporarily deactivate interior monitoring and the anti-tow system in the **Vehicle settings** menu of the infotainment system >>> page 75.

When the “Safe” security system is deactivated, the following needs to be taken into account:

- The vehicle can be unlocked and opened from the inside using an door handle.
- The anti-theft alarm is active >>> page 74.
- The interior monitoring system and the anti-tow system are disabled >>> page 75.

“Safe” status

The flashing frequency of the diode in the door sill immediately confirms the process. Initially, the diode flashes in a fast sequence for a brief period, then it stops for approximately 30 seconds and, lastly continues flashing slowly.

WARNING

Using the “Safe” security system negligently or without paying due attention can cause serious injuries in the event of an emergency.

- Never leave anyone inside the vehicle when you lock it with the key. When the “Safe” security system is active the doors cannot be opened from the inside!

Troubleshooting**The control lamp remains on**

The red LED on the driver’s door flashes at short intervals and then stays on. There is a fault in the locking system.

- Contact a specialised workshop. SEAT recommends visiting a SEAT dealership for this.

The turn signals do not flash

If the turn signals do not flash as a confirmation when the vehicle is locked:


- At least one door or the rear lid are not closed **or**
- The engine bonnet is not closed.

The vehicle locks automatically

If one of the following conditions is met, the vehicle re-locks automatically after approx. 45 seconds.

- The vehicle has been unlocked, but none of the doors or the rear lid have been opened.
- The ignition has not been switched on.

What happens when locking the vehicle with a second key

They key inside the vehicle is blocked and cannot be used to start the engine as soon as the vehicle is locked from the outside with a second key. To activate the key inside the vehicle to allow it to switch on the engine, press its  button.

Locking the vehicle after an airbag is triggered

When an airbag is triggered as a result of an accident, the vehicle is fully unlocked. Depending on the extent of the damage, the vehicle may be relocked after the accident as described below:

- Switch the ignition off.
- Open the driver's door and close it again.
- Lock the vehicle.

Note

If the 12-volt vehicle battery has little or no charge, or the vehicle key battery is almost or entirely out of charge, you will probably not be able to lock or unlock the vehicle with the Keyless Access system. The vehicle can be unlocked and locked manually »» page 76.

Note

If there is no vehicle key in the vehicle or the system does not detect it, a warning will be displayed on the instrument cluster. This could happen if any other radio frequency signal interferes with the key signal or if the key is covered by another object, e.g. a metal case.

Anti-theft alarm

Description

Depending on the equipment, the vehicle may be fitted with an anti-theft alarm.

The theft alarm monitors the doors, bonnet and rear lid.

The anti-theft alarm system activates automatically when the vehicle is locked.


If the vehicle is not opened electronically with a valid key, the alarm triggers and emits audio and light signals for a maximum of approx. 5 minutes.

When is the anti-theft alarm triggered?


- If a mechanically unlocked door is opened with the vehicle key, you have 15 seconds to switch on the ignition before the alarm is triggered (depending on markets, the 15 seconds waiting time disappears and the alarm is triggered immediately when the door is opened).
- If the bonnet is opened.
- If the rear lid is opened.
- If an invalid vehicle key is used.
- If there are movements inside the vehicle (in vehicles with interior monitoring »» page 75).
- If the vehicle is lifted or towed (for vehicles with an anti-tow system »» page 75).

- If the vehicle is transported on a ferry or by rail (in vehicles with an anti-tow system or interior monitoring »» page 75).
- If the 12-volt battery is disconnected.
- When a trailer connected to the theft alarm system is unhitched.

Switching off the alarm

- Unlock the vehicle with the vehicle key unlocking button .
- Grip the door handle.
- Switch the ignition on.

Note

- After 28 days, the indicator light will be switched off to prevent the battery from exhausting if the vehicle has been left parked for a long period of time. The alarm system remains activated.
- If, after the audible warning goes off, another monitored area is accessed (e.g. the rear lid is opened after a door has been opened), the alarm is triggered again.
- The anti-theft alarm is not activated when the vehicle is locked from within using the central locking button .
- If the driver door is unlocked mechanically with the key, only the driver door is unlocked, the rest of the doors remain locked. Only when the ignition has been turned on will the

other doors be available - but not unlocked - and the central locking button will be activated.

- Vehicle monitoring remains active even if the battery is disconnected or not working for any reason.

Interior monitoring and anti-tow system

If movement is detected in the vehicle interior while the vehicle is locked, the interior monitoring triggers the alarm.


If it detects that the vehicle is being lifted, the anti-tow system triggers the alarm.

Switching on the interior monitoring and the anti-tow systems


- Lock the vehicle. When the anti-theft alarm is activated, the interior monitoring and the anti-tow system are as well.

Depending on the equipment, the use of a partition net can affect the operation of the interior monitoring system.

Temporarily switching off the interior monitoring and anti-tow systems

- Unlock the vehicle.
- Press the  button twice on the remote control or perform the locking movement twice with the key in the cylinder. The interior monitoring and the anti-tow systems will be deactivated. The alarm system remains activated.

Disconnect through the infotainment system

- Press the function button  > **Settings** > **Opening and closing** > **Central locking** > **Interior monitoring**.

The interior monitoring and anti-tow system remain deactivated until the next time the vehicle is locked.

To avoid false alarms, deactivate interior monitoring and the anti-tow system in the following situations:

- When people or animals remain inside the vehicle.
- When the vehicle is to be loaded onto another means of transport, transported or towed.
- When the vehicle is to be left in a car wash or is to be parked in a double-decker garage.

Risk of false interior monitoring alarms

The interior monitoring system will only operate correctly if the vehicle is completely locked. Please bear in mind all legal provisions. The following situations may cause a false alarm:

- If one or more windows are partially or completely open.
- If light objects are left inside the vehicle, e.g. loose paper or items hanging from the interior mirror.
- If the vibrate function of a mobile left inside the vehicle is activated.

Note

- It is not possible to permanently deactivate the interior monitoring and anti-tow systems.
- If any doors or the rear lid are open when the anti-theft alarm is activated, only the alarm will be activated. The interior monitoring and anti-tow systems will only activate once all of the doors and the rear lid are closed.
- When the interior monitoring and anti-tow systems are switched off, the "Safe" security system is also switched off >>> page 73.

Doors

Introduction

The doors and rear lid can be locked manually and partially opened, for example if the key or the central locking is damaged.

⚠ WARNING

Opening and closing doors carelessly can cause serious injury.

- If the vehicle is locked from the outside with the "Safe" security system, the doors can no longer be opened from the inside.
- Never leave children or disabled people alone in the car. They could be trapped in the car in an emergency and will not be able to get themselves to safety.
- Depending on the time of the year, temperatures inside a locked and closed vehicle can be extremely high or extremely low, resulting in serious injuries and illness or even death, particularly for young children.

⚠ WARNING

Getting in the way of the doors and the rear lid is dangerous and can lead to serious injury.

- Open and close the doors and the rear lid only when there is nobody in the way.

ⓘ NOTICE

In certain weather conditions, ice or snow may accumulate on the lower front part of the doors between the door frame and the door; do not force the doors open until you are sure that there is no ice or snow.

ⓘ NOTICE

When opening and closing in an emergency, carefully disassemble components and then reassemble them carefully to avoid damage to the vehicle.

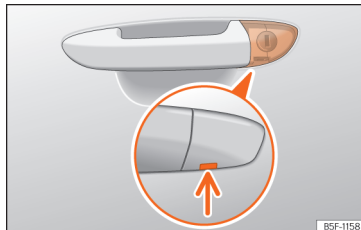
Emergency unlocking or locking of the driver's door

Fig. 51 Driver's door handle: hidden lock cylinder.

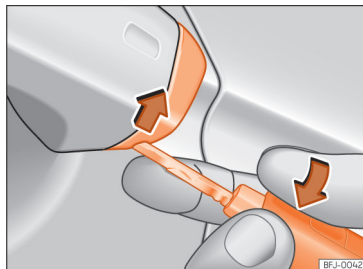


Fig. 52 Driver's door handle: pry the cover open.

If the central locking system should fail to operate, the driver's door can still be locked and unlocked by turning the key in the lock.

As a general rule, when the driver's door is locked manually all other doors are locked. When it is unlocked manually, only the driver's door opens. Please observe the instructions relating to the anti-theft alarm system **>>> page 74.**

- Unfold the vehicle key blade.
- Insert the key blade into the lower opening in the cover on the driver's door handle then remove the cover upwards **>>> Fig. 52.**
- Insert the key blade into the lock cylinder to unlock or lock the vehicle.

Special characteristics

- The anti-theft alarm will remain active when vehicles are unlocked. However, the alarm will not be triggered ››› page 74.
- After the driver's door is opened, you have 15 seconds to switch on the ignition. Once this time has elapsed, the alarm is triggered.
- Switch the ignition on. The electronic immobilizer recognises a valid vehicle key and deactivates the anti-theft alarm system.

Note

The anti-theft alarm is not activated when the vehicle is locked manually using the key blade ››› page 70.

Emergency lock of doors without lock cylinders



Fig. 53 Locking the door manually.

If the central locking system fails or the vehicle's battery goes flat, doors with no lock cylinder will have to be locked separately.

The emergency lock is located on the front of the front passenger's door and the rear doors. It can only be seen if the door is open.

- Pull the cap out of the opening.
- Insert the key in the inside slot and turn it to the right as far as it will go (if the door is on the right side) or to the left (if the door is on the left side).
- Replace the cap.

Once the door has been closed it can no longer be opened from the outside. Pull the interior door handle once to unlock and open the door.

Child lock

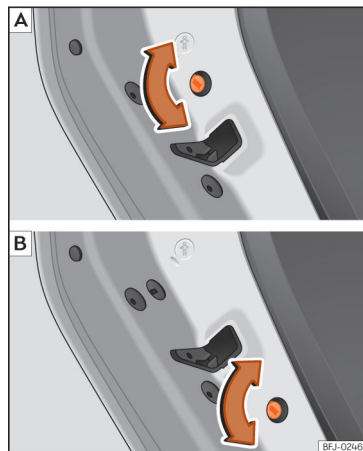


Fig. 54 Child safety lock on the left door [symmetrical on the right door]. Depending on the version or country, the vehicle is fitted with variant **A** or variant **B**.

The child lock prevents the rear doors being opened from the inside. Its function is to prevent children from inadvertently opening a single door while the vehicle is in motion.

This function is separate from the vehicle's electronic unlocking/locking systems. It only works on the rear doors. It can only be activated and deactivated manually, as described below.

Activating the child lock

- Unlock the vehicle and open the door on which the child safety lock is to be activated.
- With the door open, turn the slot with the vehicle key clockwise for the left doors »» Fig. 54 and anticlockwise for the right doors.

When the child lock is activated, the doors can only be opened from the outside.

Deactivating the child lock

- Unlock the vehicle and open the door from which you want to remove the child lock.
- With the door open, turn the slot with the vehicle key anticlockwise for the left doors »» Fig. 54 and clockwise for the right doors.

WARNING

The doors cannot be opened from the inside when the child lock is activated. This means that people may be locked inside the vehicle. In an emergency, they may not be able to leave the vehicle independently or save themselves.

- Never leave children or persons in need of assistance unattended in the vehicle when the doors are locked.

WARNING

If children, persons requiring assistance or animals are left unattended inside the vehicle, they could be exposed to very high or very low temperatures. There is a risk of serious or fatal injuries.

- Never leave children, persons in need of assistance or animals unattended in the vehicle.

Rear lid

Introduction

The rear lid unlocks and locks together with the doors.

On vehicles with the Keyless Access start/locking system, the rear lid automatically unlocks when it is opened »» page 68.

WARNING

Careless and unsuitable locking, opening and closing of the rear lid can cause accidents and serious injury.

- Do not close the rear lid by pushing it down with your hand on the rear window. The glass could smash. Risk of injury!
- Ensure the rear lid is locked after closing it. If not, it may open unexpectedly while driving.

- Never open or close the rear lid carelessly or in an uncontrolled manner, as this could cause serious injuries to you or third parties. Make sure that no person or object is in the way of the rear lid as it closes or opens.

- Never drive with the rear lid open or half-closed, exhaust gases may penetrate into the interior of the vehicle. Danger of poisoning!

- Never open the rear lid if there is cargo, e.g. bicycles, attached to it. The rear lid may close by itself due to the additional weight. If necessary, remove the cargo first or hold the rear lid.

- Never leave the vehicle unattended or allow children to play inside or next to it, especially if the rear lid is open. Children could enter the luggage compartment, close the rear lid and become trapped. A locked vehicle can reach extremely high and low temperatures, depending on the time of year, thus causing serious injuries, illness or even death.

NOTICE

- Before opening or closing the rear lid, make sure that there is enough space to open or close it, e.g. when pulling a trailer or in a garage.

- Never use the rear wiper or rear spoiler to secure cargo or as a handhold. This could cause damage that could lead to the breakage of the rear wiper or spoiler.

Note

Before closing the rear lid, make sure that the key has not been left inside the luggage compartment.

Opening and closing the rear lid

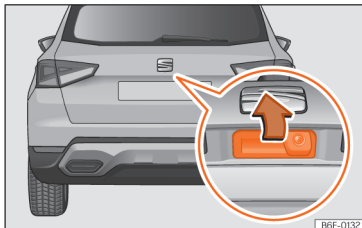




Fig. 55 Rear lid: opening from the outside.

To lock or unlock the rear lid, press the  or  buttons on the vehicle key.

Opening and closing

- *Open*: place slight pressure on the handle. The rear lid opens automatically >>> **Fig. 55**.
- *Close*: grip the rear lid by one of the handles on the interior trim and move it downwards to close.

If the doors are locked, the rear lid is also locked.

A warning appears on the instrument panel display if the rear lid is open or not properly closed.

The rear lid locks automatically while driving.

When the outside temperature is around freezing, the opening mechanism cannot always raise the rear lid. Lift the rear lid by hand.

Note

If the rear lid is not opened within a few minutes of being unlocked, it re-locks automatically.

Emergency unlocking of the rear lid

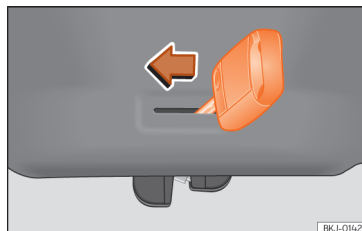


Fig. 56 Luggage compartment: manual release.

The rear lid can be unlocked from inside in the event of an emergency (e.g. if the 12 volt battery is flat).

There is a groove in the luggage compartment allowing access to the emergency opening mechanism.

Unlocking the rear lid from inside the luggage compartment

- Insert the key blade into the slot and move the key in the direction of the arrow until the lock unlocks >>> **Fig. 56**.

Window controls

Opening and closing the windows

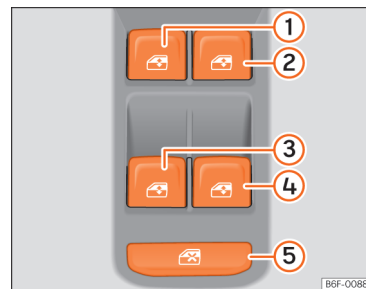




Fig. 57 Detail of the driver's door: window controls.

- Open the window: press button 
- Close the window: pull button 

Buttons on the driver's door

- ① Left-hand front door window
- ② Right-hand front door window
- ③ Left-hand rear door window
- ④ Right-hand rear door window
- ⑤ Safety control for deactivating the window control buttons on the rear doors

Both front and rear windows can be operated from the controls on the driver's door. The other doors have a separate control for each window.

Always close the windows completely when the vehicle is parked or out of sight **>>> ⚠**.


You can use the electric windows for approx. 10 minutes after switching off the ignition if neither the driver's door nor the front passenger door have been opened and the ignition key has not been removed (depending on the equipment).

Safety switch 

The safety control **>>> Fig. 57 ⑤** on the driver's door can be used to disable the electric window buttons on the rear doors.

Safety control not pressed: the buttons on the rear doors are activated.


Safety control pressed: the buttons on the rear doors are deactivated.

The safety control symbol  lights up in yellow if the buttons on the rear doors are switched off.

Comfort opening and closing¹⁾


The windows can be opened and closed from the outside using the vehicle key:

Convenience opening:

- Press and hold the  button on the remote control key until all the windows have reached the desired position.


- **OR:** Keep the key in the driver's door in the "open" position until all the windows open to the desired position.

Convenience closing:

- Press and hold the  button on the remote control key until all the windows are closed **>>> ⚠**.

- **OR:** Keep the key in the driver's door in the "lock" position until all the windows are closed.

- **OR:** using the Keyless Access system (only locking): Press and hold the locking sensor surface **>>> Fig. 48 B** (arrow) on the door handle for several seconds to close the windows. If you stop touching the sensing surface, the locking function is interrupted.

In the infotainment system different settings can be adjusted using the function button  **> Settings > Opening and closing > Window operation > Convenience opening.**

One-touch opening and closing

Automatic raising and lowering fully opens and closes the windows. It is not necessary to press and hold the appropriate window button for this purpose.

For the automatic raising function: pull the button for the corresponding window upwards until it reaches the second position.

For the automatic lowering function: push the button for the corresponding window downwards until it reaches the second position.

Stop automatic movement: push or pull on the button of the corresponding window.

Resetting the automatic raising/lowering function


If the 12-volt battery is disconnected or discharged when the windows are not completely closed, the electric window automatic raising and lowering function deactivates and has to be reset:

- Switch the ignition on.
- Close all doors and windows.
- Pull the corresponding window button upwards and hold it in this position for a few seconds.
- Release the button, pull it up again and hold it in this position. This resets the automatic raising and lowering function.

¹⁾ Not available in vehicles without the "Safe" **>>> page 73** system.

The function can be reset for a single window or for several windows at the same time.

WARNING

Observe the safety warnings >>>  in *Introduction* on page 76.

- Improper use of the power windows can cause injury.
- Never close windows carelessly or in an uncontrolled manner, as this could cause serious injuries to you or third parties. Therefore, make sure that no one is in the way of the moving windows.
- If the ignition is switched on, electrical equipment such as the power windows could activate, which can cause injury.
- The vehicle doors can be locked with the remote control key, making it difficult to get help in an emergency.
- Therefore always take the key with you when you leave the vehicle.
- The power windows are only deactivated when the ignition is switched off and one of the front doors is opened.
- If necessary, deactivate the rear power windows with the safety control. Make sure that they have actually been deactivated.
- For safety reasons, you should only unlock and lock the vehicle with the remote control key when you are approximately 2 metres away from the vehicle. When pressing the lock button, always monitor the movement


of the windows to avoid accidents. Releasing the button immediately interrupts the closing process.


Note

If the window is not able to close because it is stiff or because of an obstruction, the window will automatically open again >>> page 81. In this case, check why the window could not be closed before trying again.

Window anti-trap function

The roll-back function reduces the risk of injury when the power windows close.


If a window encounters resistance or an obstacle when closing, it will reopen immediately >>> .

- Check why the window does not close.
- Try closing the window again.
- If the closing process is interrupted again, the anti-trap function stops working for a few seconds.
- If the window still cannot be closed, it will stop in the corresponding position. Pulling the button again within a few seconds closes the window **without the anti-trap function** >>> .

Closing the windows without the anti-trap function

- Try to close the window again by pulling the button without releasing it, within a few seconds. **The anti-trap function will be deactivated!**
- If the closing process takes longer than a few seconds, the anti-trap function is activated again. The window will stop again if it encounters resistance or an obstacle, and will reopen automatically.
- If the window will still not close, visit a specialised workshop.

WARNING

Observe the safety warnings >>>  in *Opening and closing the windows* on page 81.

- The roll-back function does not prevent fingers or other parts of the body getting pinched against the window frame. Risk of accident.

Note

The anti-trap function also works when the windows are closed with the comfort function using the vehicle key.

Steering wheel

Multifunction steering wheel

Functions

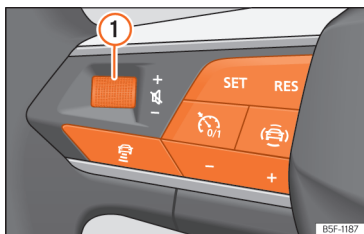


Fig. 58 Controls on the steering wheel.

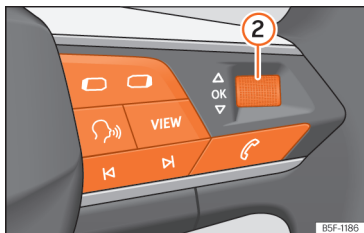


Fig. 59 Controls on the steering wheel.

The steering wheel includes multifunction modules from where it is possible to control the audio, telephone, navigation, voice control and assist functions without the driver needing to be distracted from the road.

Buttons available depending on the version

①	<p><i>Turn:</i> Turn volume up/down. <i>Press:</i> Mute volume.</p>
②	<p><i>Turn:</i> Search in the instrument panel menu. In Navigation mode, turn to zoom in/out of the map in the instrument cluster.</p> <p><i>Press:</i> Select the highlighted option in the instrument cluster</p>
	<p><i>Radio:</i> Search for the previous/next station.</p> <p><i>Media:</i> Short press: previous/next track; long press: fast forward/rewind.</p>
	Activate phone menu (answer call, end call).
	Switch between media and radio sources.
	Change the instrument panel menu (previous/next).
	Enable/disable voice control.
VIEW	Change instrument cluster views »» page 16

	Switching ACC on or off »» page 143 / Cruise control »» page 139 / Speed limiter »» page 141 / Travel Assist »» page 153.
SET	Activate ACC / Travel Assist / Speed limiter
RES	Reset programmed speed.
+ -	+ : Increase programmed speed. - : Decrease programmed speed.
	Select Travel Assist / ACC.
	Open the driver assistants menu in the instrument cluster.
	Modify the programmed ACC distance

Steering wheel position adjustment

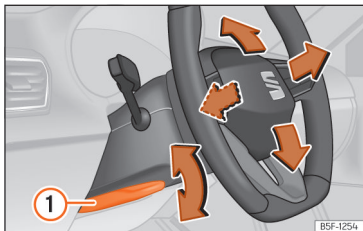


Fig. 60 Lever in the lower left side of the steering column.

Adjust the steering wheel before your trip and only when the vehicle is stationary.

- Pull lever >>> Fig. 60 ① down, move the steering wheel to the desired position and lift the lever back up until it locks.

⚠ WARNING

Incorrect use of the steering wheel adjustment function and an incorrect adjustment of the steering wheel can result in severe or fatal injury.

- After adjusting the steering column, push lever >>> Fig. 60 ① firmly upwards so that the steering wheel does not accidentally change position while driving.

- Never adjust the steering wheel while the vehicle is in motion. If you need to adjust the steering wheel while the vehicle is in motion, stop safely and make the proper adjustment.
- The adjusted steering wheel should be facing your chest and not your face so as not to hinder the driver's front airbag protection in the event of an accident.
- When driving, always hold the steering wheel with both hands on the outside of the ring at the 9 o'clock and 3 o'clock positions to reduce injuries when the driver's front airbag deploys.
- Never hold the steering wheel at the 12 o'clock position or in any other manner (e.g. in the centre of the steering wheel). In such cases, if the driver's airbag deploys, you may sustain injuries to your arms, hands and head.

Seats and headrests

Front seats

Manual adjustment of the front seats

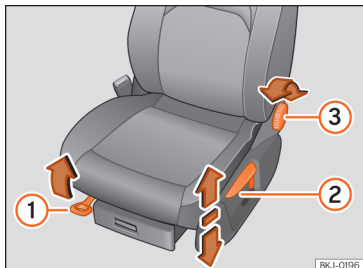


Fig. 61 Front seats: manual seat adjustment.

- 1 Pull the lever to move the seat forwards or backwards. The seat must engage when the lever is released!
- 2 Move the lever up or down to adjust the seat height; several times if necessary.
- 3 Without leaning on the seat backrest, turn the wheel to adjust the backrest.

Rear seats

Folding down and raising the rear seat backrest

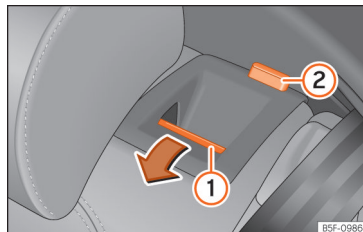


Fig. 62 Rear seat: folding down the backrest.

The rear seat backrest is split and each part be lowered separately to extend the luggage compartment.

Folding the backrest forwards

- Fully lower the rear headrests >>> page 85.
- Press the unlock button >>> Fig. 62 1 forwards and at the same time fold the backrest down. The rear seat backrest is not engaged when the red marking of the button 2 is visible.

Converting the table to a seat

- Raise and lock in the back rest. The red marking on button 2 should no longer be visible when the backrest is properly secured.

⚠ WARNING

Serious injuries can be caused if the rear seat backrest is lowered or lifted without due care and attention.

- Never lower or lift the rear seat backrest while driving.
- Do not trap or damage the seat belt when raising the rear seat backrest.
- When lowering or lifting the rear seat backrest, keep your hands, fingers, feet and other body parts out of its path.
- For the rear seat belts to offer the necessary protection all the parts of the rear backrest must be properly engaged. This is particularly important in the case of the centre rear seat. If someone is seated in a seat whose backrest is not properly engaged they will fly forward, along with the backrest, during an accident or a sudden driving or braking manoeuvre.
- A red mark on button 2 warns that the rear backrest is not engaged. Always check that the red marking is not visible when the backrest is in the upright position.
- When the rear seat backrest is lowered or is not properly engaged nobody else can travel in the corresponding seats (not even a child).

NOTICE

Serious damage can be caused to the vehicle and other objects if the rear seat backrest is lowered or lifted without due care and attention.

- Before lowering the rear seat backrest, always adjust the front seats so that neither the head restraints nor the cushions of the rear backrest can hit them.

Headrest

Introduction

The headrest adjustment and removal options are described below. Always make sure that the seats are correctly adjusted »» page 38.

All seats are fitted with a headrest. The central rear headrest is only intended for the central seat of the rear bench. Therefore, do not install it on any other seat.

Correct adjustment of the headrest¹⁾

Adjust the headrest so that its upper edge is at the same level as the top of your head, as close as possible to eye level. Keep the back of your head always as close to the headrest as possible.

¹⁾ On seats with adjustable headrests.

Adjusting the headrest for short people¹⁾

Lower the headrest completely, even if your head is below its upper edge. In the lowest position, there may be a small distance between the headrest and the backrest.

Adjusting the headrest for tall people¹⁾

Raise the headrest to the highest position.

WARNING

If travelling with the headrests removed or improperly adjusted, the risk of severe or fatal injuries in the event of accidents and sudden braking or manoeuvres increases.

- Always travel with the headrest correctly installed and adjusted.
- To decrease the risk of neck injuries in the event of an accident, adjust the headrest correctly based on your height, always making sure that its upper edge is at the same height as the top of the head, as close as possible to eye level. Keep the back of your head always as close to the headrest as possible and centred.
- Never adjust the headrest while the vehicle is in motion.
- Under no circumstances should the rear passengers travel while the headrests are in the non-use position.

NOTICE

When assembling and disassembling the headrests, do not allow them to come into contact with the vehicle's ceiling liner, the back rest of the front seat or other parts of the vehicles. Any such contact could damage the vehicle.

Adjusting the headrests

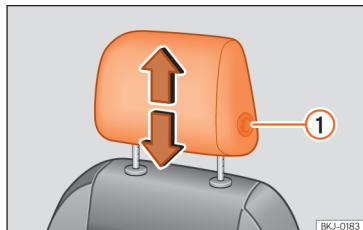


Fig. 63 Front seat: adjusting the headrest.

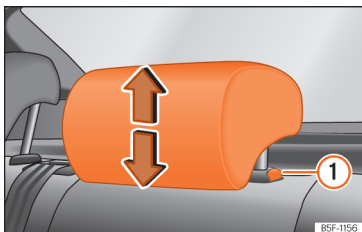


Fig. 64 Rear headrest: adjusting the headrest.

Adjusting the height of the headrests¹⁾

- Grab the sides of the headrests with both hands and push upwards to the desired position. To lower it, repeat the same action, pressing the button on the side ① »» Fig. 63, »» Fig. 64.
- The headrest must lock correctly in one position.

Removing and fitting the headrests

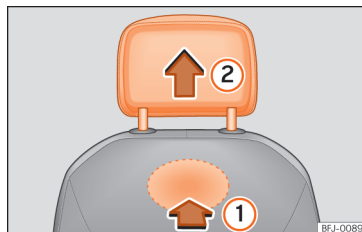


Fig. 65 Front headrest: removal.

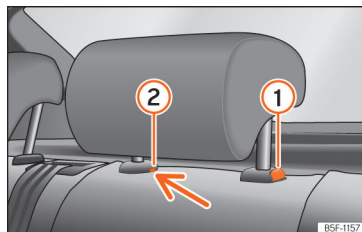


Fig. 66 Rear headrest: removal.

Removing the front headrests¹⁾

- Lower the headrest if necessary.
- To unlock it, look for the button underneath the headrest and press in the direction of the arrow »» Fig. 65 ①.
- Remove the headrest in the direction of the arrow ②.

Fitting the front headrests


- Place the headrest in the correct position on the guides of the corresponding backrest and insert it.
- Press the headrest downwards until the bars lock.
- Adjust the headrest according to the instructions on the correct position of the seat.

Removing the rear headrests

To remove the headrest, the corresponding backrest must be partially folded forward.


- Unlock the backrest »» page 84.
- Move the headrest upwards to its highest position.
- Press button »» Fig. 66 ①, while simultaneously pressing on the safety hole ② with a flat screwdriver a maximum of 5 mm wide, and remove the headrest.

¹⁾ On seats with adjustable headrests.

- Move the backrest until it engages properly
»»  in *Folding down and raising the rear seat backrest* on page 84.

Fitting the rear headrests

To mount the external headrests, the corresponding backrest must be partially folded forward.

- Unlock the backrest »» page 84.
- Insert the headrest bars into the guides until they are heard to engage. It should not be possible to remove the headrest from the backrest.
- Move the backrest until it engages properly
»»  in *Folding down and raising the rear seat backrest* on page 84.

WARNING

Remove the rear headrests only when it is necessary to fit a child seat. After removing a child seat, refit the headrest immediately.

Lights

Vehicle lighting

Indicator lamps



Lights up yellow

There is a total or partial failure of the exterior lighting.



Lights up yellow

Rear fog light on.



Lights up green

Left or right turn signal. The control lamp flashes twice as fast when a turn signal is faulty.

Hazard warning lights on >>> page 61.



Lights up green

Trailer turn signals.



Lights up blue

Main beam on or flasher on >>> page 90.



Lights up blue

The Light Assist system is on >>> page 91.

Lights control

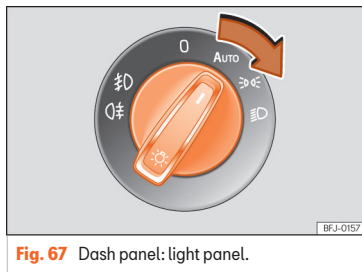


Fig. 67 Dash panel: light panel.

Turning on the lights

- Turn on the ignition and turn the light switch to the desired position >>> **Fig. 67**:

AUTO Automatic control of dipped beam headlights and daytime running lights.

☞☞ Side lights and daytime running lights on.

☞☞ Dipped beam headlight on.

0 Daytime running lights on.

Turning off the lights

- Turn off the ignition and turn the light switch to the desired position:

0 Lights off.

AUTO The “Coming home” and “Leaving home” surround lighting may be switched on.

☞☞ Side lights on.

☞☞ Dipped beam headlight off.

It is always the driver's responsibility to ensure that the vehicle is driven with the correct headlamp settings and the correct lights.

Side lights

When the side light ☞☞ is switched on, the side lights in both headlights, certain areas of the rear light clusters, the number plate light and the button lights on the instrument cluster turn on. The automatic dipped beam activates as of a speed of approx. 10 km/h (6 mph).

Automatic dipped beam headlight control **AUTO**

When the light control is in position **AUTO**, the vehicle's lighting and the lighting of the instruments and controls turn on and off under the following conditions:

- The light sensor has detected darkness.
- The wiper has been on for some time.

The automatic dipped beam is only an auxiliary function and cannot always identify all situations that may arise during driving with sufficient precision.

Cornering light function

The *cornering* light is an additional function to the dipped beam to improve lighting of the side of the road when cornering at low speeds.

When the dipped beam is on, a static cornering light comes on when driving at speeds below about 40 km/h (25 mph) or on very tight bends.

- If the steering wheel is turned or the turn signal is switched on, the front fog light gradually turns on. Once the turn has been made, the *cornering* light progressively turns off.
- When engaging reverse gear, both front fog lights turn on.

Daytime running lights

Daytime running lights can increase vehicle visibility when driving during the day.

The daytime running lights switch on every time the ignition is switched on, if the switch is in positions **0** or **AUTO**, according to the level of exterior lighting.

Motorway light

The function is switched on and off via the corresponding Infotainment system menu.

- **Activation:** when going above 110 km/h (68 mph) for more than 10 seconds, the dipped beam raises slightly to increase the driver's visibility distance.
- **Deactivation:** when the speed of the vehicle is reduced below 100 km/h (62 mph), the dipped beam immediately returns to its normal position.

Warning buzzers to warn that the lights have not been switched off

If the ignition is not switched on or the vehicle key is not in the ignition (depending on the equipment) an audible warning signal is heard in the following cases: this will remind you to turn the light off.

- When the parking light is on >>> page 90.
- When the light switch is in position >>> or >>.

If the exit lighting is switched on ("Coming Home" function), when you leave the vehicle there will be no audio warning to warn you that the lights are still on.

⚠ WARNING

Accidents can occur if the road is not well lit and other road users cannot see the vehicle or see it with difficulty.

- The automatic dipped beam control (**AUTO**) only switches on the dipped beam when there are no changes in brightness, and not, for example when it is foggy.

⚠ WARNING

The side light or daytime running light does not provide sufficient illumination to see the road properly or to be seen by drivers of other vehicles.

- Always switch on the dipped beam headlight at night, in rainy weather or when visibility is poor.
- Daytime running lights must never be used when the road is poorly lit due to weather or lighting conditions.
- On vehicles with tail lights with bulbs, switching on the daytime running lights does not switch on the tail lights. A vehicle without tail lights may not be seen by other drivers in the dark, in case of rain or unfavourable visibility conditions.

⚠ WARNING

Other road users may be distracted and dazzled if the headlights are set too high and used inappropriately. This could cause an accident, with serious consequences.

- Always make sure that the headlights are correctly adjusted.

Note

- The relevant legislation in each country must be observed when using the vehicle's lights.
- The dipped beam headlights will only work with the ignition on. When the ignition is switched off, the side light automatically turns on.

Fog lights

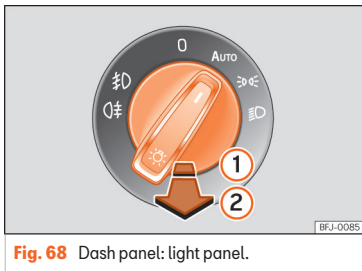


Fig. 68 Dash panel: light panel.

The warning lamps D and D also show, on the light switch or instrument cluster, when the fog lights are on.

The fog lights can be switched on with the light control in position D , D or **AUTO** when the ignition is switched on:

- **Turning on the fog lights** D : pull the light switch to its first position \ggg Fig. 68 ①.
- **Turning on the rear fog light** D : pull the light switch fully out ②.
- To switch off the fog lights, press the light switch or turn it to position 0.

Note

The rear fog light can dazzle drivers behind you. You should use the rear fog light only when visibility is very poor.

Turn signal and main beam lever

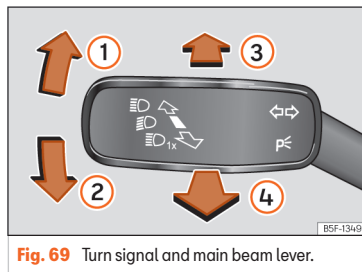


Fig. 69 Turn signal and main beam lever.

Move the lever to the required position:

- ① Right turn light or right-hand parking light (ignition switched off).
- ② Left turn light or left-hand parking light (ignition switched off).

- ③ Turning on the main beam. The control lamp D lights up on the instrument cluster.
- ④ The headlight flasher turns on when the lever is pulled. The control lamp D lights up on the instrument cluster.

Place the lever in rest position to turn off the corresponding function.

Convenience turn signals

When the ignition is switched on, move the lever as far as possible upwards or downwards and release the lever. The turn signal will flash three times.

To switch off the convenience turn signal early, immediately move the lever in the opposite direction until you feel resistance and release it.

The convenience turn signals are switched on and off in the infotainment system using the function button D > **Settings** > **Lighting** > **Lighting assistant** > **Convenience turn signals**.

Parking light P

The parking lights will only work with the ignition off. If said light is on, an audible warning will sound while the driver door is open.

- Switch the ignition off.
- Move the turn signal lever up or down.

When the parking light is switched on, the front side light and the tail light on the corresponding side of the vehicle turn on.

WARNING

Using turn signals inappropriately, not using them or forgetting to turn them off can confuse other road users. This could cause an accident with serious consequences.

- Always give warning of lane changes, overtaking or turning manoeuvres by activating the turn signals well in advance.
- As soon as the lane change, overtaking or turning manoeuvre is complete, switch off the turn signal.

WARNING

Improper use of the main beam can cause accidents and serious injuries, as it can distract and dazzle other drivers.


Note

- When you turn the ignition off without having turned the turn signals off, an audible signal sounds while the driver door is open. It is intended to remind you to turn off the turn signals, unless you want to leave the parking light on.
- If the convenience turn signals are on (three flashes) and the convenience turn signal on the opposite side is activated, the active side stops flashing and only flashes once on the newly selected side.


- The turn signal only works when the ignition is switched on. The turn signals only work when the ignition is switched on.
- The *main beam* can only be switched on when the dipped beam is switched on.
- If a trailer turn signal fails, the indicator light (trailer turn signals) stops flashing, instead of flashing the turn signal at double speed in the vehicle.
- In cold or wet weather conditions, the headlights, tail lights and turn signals may be temporarily fogged from the inside. This is normal and has no effect on the service life of the vehicle's lighting system.
- The parking light does not activate automatically if the left- or right-hand turn signal is left on and the ignition is disconnected.



Main beam assist (Light Assist)

The main beam assist automatically prevents glare from affecting vehicles moving in the opposite direction or ahead in the same direction. In addition, the main beam assist detects illuminated areas and disconnects the main beam headlight when passing populated areas.


Within its limitations, the assist system automatically connects or disconnects the main beam headlight depending on the environmental and traffic conditions, as well as the speed >>> .

(A) Switching on the main beam assist

- Turn on the ignition and turn the light switch to position **AUTO**.
- From the neutral position, press the turn signal and main beam headlights lever forwards >>> Fig. 69 .

When the main beam assist is switched on, the control lamp  on the instrument cluster display turns on. When the main beam is on, the blue main beam control lamp  on the instrument cluster switches on.

Switching the main beam assist off

- Turn the headlight switch to a position other than **AUTO**.
- **EITHER:** if main beam assist is on, pull the turn signal light and main beam headlights lever back >>> Fig. 69 .
- **OR:** if the main beam assistant is on, but the main beam **does not** turn on, press the turn signal and main beam lever forwards to turn the main beam on manually. Pull the turn signal and main beam lever back to switch off the main beam manually, if necessary.
- **OR:** switch off the ignition.

System limitations

In the following cases, the main beam headlight must be switched off manually because the main beam assist will not disconnect it on time or disconnect it at all:

- On insufficiently lit roads with highly reflective signs.
- If road users have insufficient lighting, e.g. pedestrians or cyclists.
- On tight curves, when the traffic in the opposite direction is partially hidden, on pronounced slopes or inclinations.
- On roads with traffic in the opposite direction and with a central reservation barrier where the driver can see over it e.g. lorry drivers.
- In case of fog, snow or heavy rainfall.
- In case of swirling dust or sand.
- If the windscreen is damaged in the camera's field of vision.
- If the camera's field of vision is misted up, dirty or covered by a sticker, snow or ice.
- If the camera is damaged or if the power supply has been cut off.

WARNING

The comfort features of the main beam assist must not lead you to take any risks. The system is not a replacement for driver concentration.

- You must always control the main beam yourself and adapt it to the light, visibility and traffic conditions.
- The main beam regulator may not recognise all driving situations correctly and may operate with limitations in certain circumstances.

- When the camera's field of view is dirty, covered or damaged, the operation of the main beam regulator may be affected. This also applies when the vehicle's lighting installation is modified, e.g. when additional headlamps are installed.

NOTICE

To avoid affecting the operation of the system, take the following points into consideration:

- Clean the field of vision of the camera regularly and make sure it is free of snow and ice.
- Do not cover the field of vision of the camera.
- Check that the windscreen is not damaged in the area of the camera's field of view.

Note

- The headlight flasher can be turned on and off manually at any time with the turn signal and main beam lever >>> page 90.
- If there are objects that radiate light in the camera's area of influence, e.g. a portable navigation system, this may affect the operation of the main beam assist system.

“Coming home” and “Leaving home” function (exterior orientation lighting)

The “Coming home” and “Leaving home” function lights up the vehicle's immediate surroundings when getting into and out of it in the dark.

This light is automatically controlled by a light sensor.

Turning on the “Leaving home” light

- Unlocks the vehicle (if the light switch is in position **AUTO** and the light sensor detects darkness).

Turning off the “Leaving home” light

- It turns off automatically once the lights off delay time has elapsed.
- **OR:** lock the vehicle.
- **OR:** rotate the light switch to position **0**.
- **OR:** switch on the ignition.

Turning on the “Coming home” light

- Switch the ignition off.

The “Coming Home” light turns on if the light control is in position **AUTO** and the light sensor detects darkness.

The lights-off delay countdown starts when the last door or rear lid of the vehicle is closed.

Turning off the “Coming home” light

- It switches off automatically after the set lights-off delay time has elapsed.
- **EITHER:** it is automatically deactivated if, 30 seconds after the function has been activated, any vehicle door or the rear lid is still open.
- **OR:** rotate the light switch to position 0.
- **OR:** switch on the ignition.

“Coming home” and “Leaving home” settings

The duration of the lights-off delay can be set in the vehicle settings menu of the infotainment system, where the function can also be activated and deactivated » page 35.

Headlight range control



Fig. 70 Next to the steering wheel: headlight range control regulator.

The headlight range control » Fig. 70 adapts the headlight's beam according to the vehicle's load level. This gives the driver optimum visibility and ensures that the headlights do not dazzle oncoming drivers » Δ.

The headlights can only be adjusted when the dipped beam is switched on.

To adjust, turn the control » Fig. 70:

Value	Vehicle load status ^{a)}
–	Two front occupants, luggage compartment empty
1	All seats occupied, luggage compartment empty
2	All seats occupied, luggage compartment full. With trailer and minimum drawbar load.
3	Driver only, luggage compartment full. With trailer and maximum drawbar load.

^{a)} If the vehicle load does not correspond to those shown in the table, it is possible to select intermediate positions.

Dynamic headlight range control

The control is not fitted to vehicles with dynamic headlight range control. The headlight range is automatically adjusted according to the vehicle load status when they are switched on.

⚠ WARNING

Heavy objects in the vehicle may mean that the headlights dazzle and distract other drivers. This could cause an accident, with serious consequences.

- **Adjust the light beam to the vehicle load status so that it does not blind other drivers.**

Driving abroad

The light beam of the dipped beam lights is asymmetric: the side of the road on which you are driving is lit more intensely.

When a car that is manufactured in a country that drives on the right travels to a country that drives on the left (or vice versa), it is normally necessary to cover part of the headlight bulbs with stickers or to change the adjustment of the headlights to avoid dazzling other drivers.

In such cases, the regulations specify certain light values that must be complied with for designated points of the light distribution. This is known as “Tourist light”.

The light distribution of the headlights allows the specific “tourist light” values to be met without the need for stickers or changes being made to the settings.

For ECOLED headlamps, it is necessary to lower the mechanical adjustment of the headlamps by 0.15° [2.6 cm at 10 m]. To do this, open the bonnet and adjust the vertical adjustment screws on both headlights. When the vehicle

returns to its country of origin, the mechanical adjustment must be reset to its original status. If you do not have experience with this type of adjustment, SEAT recommends that you go to a technical service centre.

Note

“Tourist light” is only allowed temporarily. If you are planning a long stay in a country that drives on the other side, you should take the vehicle to an Authorised Technical Service to change the headlights.

Interior lights

Lighting of the instrument cluster, displays and controls

The brightness of the instrument and control lighting can be adjusted in the infotainment system:

- Select  > **Settings** > **Lighting** > **Vehicle interior lighting**; OR  > **Interior settings** > **Lighting** > **Instrument cluster**.

The set intensity automatically adapts to changes in ambient brightness in the vehicle.

When the automatic dipped beam light **AUTO** is turned on, a sensor automatically turns the dipped beam light on or off, along with the instrument and control lighting, depending on the ambient brightness.


In some cases, e.g. when driving through a tunnel without the automatic dipped beam light **AUTO** function switched on, the instrument cluster lighting may even switch off. The objective of this function is to provide the driver with a visual indication that he or she should activate the dipped beam. If your vehicle is fitted with a digital instrument cluster, the message **Turn on the lights** will be displayed on the instrument cluster.

Interior and reading lights



Fig. 71 Detail of headliner: front interior lighting.

 Turning the interior lights on or off.

 **OFF** Door contact connection. The interior lights come on automatically when you unlock the vehicle, open a door or remove the key from the ignition. The light goes out

a few seconds after closing all the doors, when locking the vehicle or connecting the ignition.

 Turning the reading light on and off



The light controls may vary depending on the vehicle version.



Luggage compartment lighting

The light is activated when the rear lid is open, even when the ignition and lights are turned off. For this reason, ensure that the rear lid is always closed.

Background lighting

The background lighting lights up the area of the centre console and the footwell area and, depending on the version, the front door panels and the air vents as well.

It will be switched on at full brightness when the doors are opened and the lights will be dimmed during driving, when the light selector is in ,  or **AUTO**.

The brightness and colour of the background lighting can be adjusted in the infotainment menu using the function button  > **Settings** > **Background lighting**; OR  > **Background lighting**.

Note

If not all the doors are closed, the interior lights will switch off after approx. 10 minutes, providing the ignition has been turned off and the door contact is connected. This prevents the battery from discharging.

Visibility

Windscreen wiper and rear window wiper systems

Wiper lever

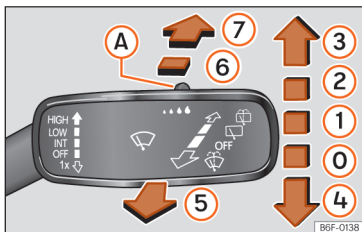


Fig. 72 Operation of windscreen wipers and rear window wiper system.

Move the lever to the required position:

OFF ① Windscreen wipers off.

INT ① Intermittent wiping of the windscreen or activates the rain sensor. The intermittent wiping of the windscreen depends on the speed at which you are driving. The faster the speed, the more frequent the wiping.

LOW ② Slow wipe.

HIGH ③ Fast wipe.

1x ④ Short wipe. Pressing the lever for longer accelerates wiping.

⑤ Pull the lever to switch on the automatic windscreen washer/wiper. The Climatronic switches on air recirculation for approx. 30 seconds to prevent the smell of windscreen washer fluid from entering the vehicle interior.

⑥ Switches on the intermittent rear window wiper. The wiper operates at intervals of approx. 6 seconds.

⑦ Pressing and holding the lever turns on the automatic rear window washer/wiper.

A A Control for adjusting the duration of the wiping intervals (vehicles without rain and light sensors) or the sensitivity of the rain sensor.

⚠ WARNING

If insufficient antifreeze is added to the washer fluid, it could freeze on the glass and impair visibility.

- Do not use the wiper system in winter temperatures without first heating the windscreen with the heating and ventilation system. Windscreen washer fluid could freeze on the windscreen and impair forward visibility.

⚠ WARNING

The use of worn or dirty wiper blades reduces visibility and increases the risk of serious accidents and injuries.

- Replace the wiper blades whenever they are in poor condition or worn out and no longer clean the windows sufficiently » page 252.

ⓘ NOTICE

Before driving off and before switching on the ignition, check the following aspects of the wiper blades and the wiper motor to prevent damage to the glass:

- The wiper lever is in the neutral position.
- You have removed or cleared any snow and ice from the wiper blades and windows.
- You have carefully removed any wiper blades that may have frozen from the window. SEAT recommends an de-icer spray for this purpose.

ⓘ NOTICE

Turn of the wiper before the glass is completely dry. Using the wipers while dry can damage the glass.

Note

- When the vehicle stops while the wiper is on, the wiper switches to operating temporarily at the next lower wiping level.
- In winter, the service position of the wipers can be useful to make it easier to lift the wipers off the windscreen when the vehicle is going to be left stationary >>> page 252.

Wiper functions

Automatic rear window wipe

The rear wiper switches on automatically when the wiper is switched on and reverse gear is engaged. The automatic rear window wiper activation when engaging reverse gear can be activated and deactivated in the infotainment system, in the vehicle settings menu >>> page 35.

Note

The windscreen will be wiped again approximately 5 seconds after the windscreen washer has been activated, provided the vehicle is moving ("drip" function). If you activate the wipers less than 3 seconds after the "drip" function, a new wash sequence will begin without performing the last wipe. For the "drip" function to work again, you have to turn the ignition off and then on again.

Note

The wiper will try to wipe away any obstacles that are on the windscreen. The wiper will stop moving if the obstacle is still blocking its path. Remove the obstacle and switch on the wiper again.

Rain and light sensor

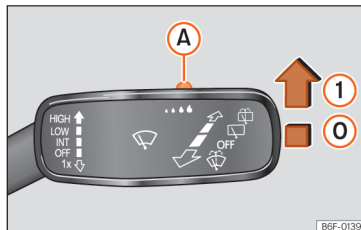


Fig. 73 Windscreen wipers lever: adjust the rain sensor **A**.

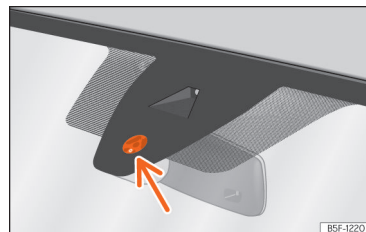


Fig. 74 Sensitive surface of the rain sensor.

The rain sensor controls the frequency of the windscreen wiper intervals, depending on the amount of rain >>> .

Push the lever to the desired position >>> **Fig. 73**.

- 0** Rain sensor deactivated.
- 1** Rain sensor active; automatic wiping if necessary.
- A** Setting sensitivity level of rain sensor:
 - Set control to the right: high sensitivity.
 - Set control to the left: low sensitivity.

When the ignition is switched off and then back on, the rain sensor stays on and starts operating again when the windscreen wipers are in position >>> **Fig. 73** **1** and the vehicle is travelling at more than 16 km/h [10 mph].

Abnormal operation of the rain and light sensor

The possible causes of anomalies and erroneous interpretations *in the sensitive surface area* »» Fig. 74 of the rain sensor are, among others:

- **Damaged wipers:** a film of water on the damaged blades may lengthen the activation time, reduce the washing intervals or result in a fast and continuous wipe.
- **Insects:** the impact of insects may cause the wiper to activate.
- **Salt on the road:** in winter, salt spread on the roads may cause an excessively long wipe when the windscreen is almost dry.
- **Dirt:** dry dust, wax, coating on glass (Lotus effect) or traces of detergent (car wash) may reduce the effectiveness of the rain sensor or make it react more slowly, later or not at all. Regularly clean the sensitive surface of the rain sensor »» Fig. 74 (arrow) and check for possible damage to the wiper blades.
- **Windscreen crack:** the impact of a stone will trigger a single wipe cycle with the rain sensor on. The rain sensor then detects the reduction of the sensor surface and adjusts itself. The behaviour of the sensor may vary depending on the size of the stone impact.

WARNING

The rain sensor may not detect rain sufficiently and may not activate the windscreen wipers.

- If necessary, switch on the windscreen wipers manually when water hinders the view through the windscreen.

Note

- The use of an alcohol-based glass cleaner is recommended to remove waxes and coatings.
- Do not put stickers on the windscreen in front of the rain sensor. This can cause alterations or failures.

Mirrors

General safety instructions

The exterior and interior mirrors allow the driver to observe vehicles driving behind and adapt his or her driving behaviour accordingly.

For safe driving, it is important for the driver to adjust the exterior mirrors and interior mirror correctly before setting off.

When looking through the exterior mirrors and the interior mirror, it is not possible to see the entire area behind and to the sides of the vehi-

cle. These areas outside the field of view are known as the blind spot. Other road users and objects may be in the blind spot.

WARNING

Adjusting the exterior mirrors and interior mirror while driving can distract the driver. This could cause accidents and lead to serious injuries

- Only adjust the exterior mirrors and interior mirror when the vehicle is stationary.
- When parking, changing lanes, overtaking or turning, always keep a close eye on your surroundings, as other road users or objects may also be in the blind spot.
- Always make sure that the mirrors are adjusted correctly and that visibility to the rear is not reduced by ice, snow, fogging or other objects.

WARNING

A failure to accurately estimate the distance to vehicles driving behind can lead to serious accidents and injuries.

- Curved (convex or aspherical) mirrors increase the field of view and objects in them appear smaller and further away.
- Curved mirrors do not allow you to precisely calculate the distance to vehicles driving behind, so using them when changing lanes could cause serious accidents and injuries.

- If possible, use the interior mirror to precisely calculate the distance to vehicles driving behind you, or to other objects.
- Always make sure you have sufficient visibility to the rear.

⚠ WARNING

The automatic anti-dazzle mirrors contain an electrolyte fluid which could leak if the mirror is broken.

- If it gets out, the electrolyte fluid can irritate the skin, eyes and respiratory organs, particularly in the case of people with asthma or similar diseases. Immediately inhale enough fresh air and get out of the vehicle, or open all windows and doors if this is not possible.
- If the electrolyte fluid comes into contact with your eyes or skin, immediately rinse the affected area with plenty of water for at least 15 minutes and seek medical advice.
- If the fluid comes into contact with footwear or clothing, rinse immediately with plenty of water for at least 15 minutes. Clean thoroughly before using the footwear or clothing in question again.
- If the electrolyte fluid is swallowed, immediately rinse the mouth with plenty of water for at least 15 minutes. Do not induce vomiting unless advised by a doctor. Immediately seek medical attention.

ⓘ NOTICE

Electrolyte fluid may leak if the automatic anti-dazzle mirror is broken. This liquid attacks plastic surfaces. Therefore, it should be cleaned as fast as possible with a damp sponge or similar.

Interior mirror

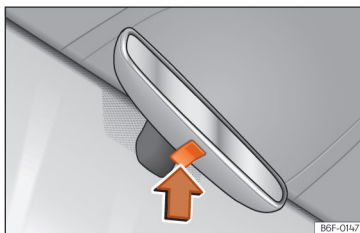


Fig. 75 Manual anti-dazzle function for interior mirror

Manual anti-dazzle function for interior interior mirror

- To darken the interior mirror, press the mirror button upwards »»» **Fig. 75** (arrow).
- To return to the basic position, press the back of the button.

Interior mirror with automatic anti-dazzle function

When the ignition is switched on, the sensors in the mirror measure the light falling on it from behind and in front.

The interior mirror automatically darkens based on the measured values.

If the light falling onto the sensors is blocked or interrupted, e.g. by a sunshade blind or hanging objects, the automatic anti-dazzle interior mirror does not work or does not work properly. Similarly, the use of portable navigation devices attached to the windscreen or close to the automatic anti-dazzle interior mirror can affect the operation of the sensors »»» ⚠.

The automatic anti-dazzle function is deactivated in certain situations, e.g. when reverse gear is engaged.

⚠ WARNING

Light from screens of portable navigation devices can cause malfunctions of the automatic anti-dazzle interior mirror and may cause serious accidents and injuries.

- Abnormal operation of the automatic anti-dazzle function may result in it being impossible to use the interior mirror to precisely calculate the distance to vehicles driving behind, or to other objects.

Adjusting the exterior mirrors

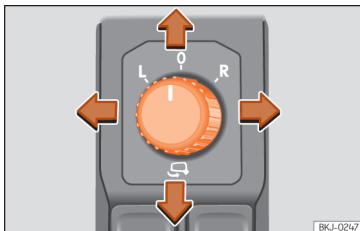



Fig. 76 Driver's door detail: exterior mirror control.


Turn the control to the corresponding position:

L/R Moving the control to the desired position adjusts the mirrors on the driver's side (L, left) and on the passenger's side (R, right) in the desired direction.

 Fold-in mirror function.


0 The exterior mirror cannot be adjusted and all functions are deactivated.

Heated exterior mirrors

- Press the demisting switch  next to the air conditioning controls >>> page 102.
- The mirrors only defog for a few minutes to avoid unnecessary battery drain.

- Press again to reactivate the function if necessary.
- The heating of the exterior mirrors is activated based on the outside temperature.


Folding the exterior mirrors when locking the vehicle

Button  > **Settings > Mirrors and wipers > Mirrors** in the infotainment system can be used to select the folding of external mirrors when the vehicle is parked and locked >>> page 35.

When the vehicle is locked or unlocked from the outside, the exterior mirrors may fold in or out automatically, depending on the equipment.

If the rotary control of the electric exterior mirrors is in the folded position, the exterior mirrors remain folded.

Manually folding the exterior mirrors

The vehicle's exterior mirrors can be folded in. To do this, press the mirror housing towards the vehicle >>> .

NOTICE

The electrically folding exterior mirrors must only be operated electrically, not by hand, as this could damage their electric drive.

NOTICE

Before washing the vehicle in an automatic car wash, please make sure that the exterior mirrors are folded in to prevent them from being damaged.

Note

- If the electrical adjustment should fail to operate, both of the mirrors can be adjusted by hand by lightly pressing the edge of the mirror glass.
- The folding function on the exterior mirrors will not activate at speeds over 40 km/h [25 mph].

WARNING

Folding the exterior mirrors in and out carelessly can cause injury.

- Only fold or unfold the exterior mirror if there is no one in the path of the mirror.
- When moving the mirror, be careful not to pinch your fingers between the mirror and the mirror holder.

Sun protection

Sun blind

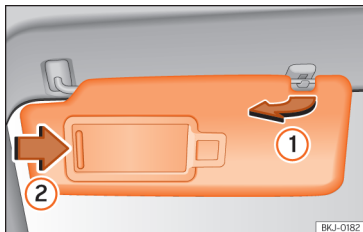


Fig. 77 Sun visor

Options for adjusting driver and front passenger sun visors

- Lower the sun visor towards the windscreen.
- The sun visor can be pulled out of its mounting and turned towards the door >>> **Fig. 77** ①.
- Swing the sun visor towards the door, longitudinally backwards.

There is a vanity mirror on the sun visor, with a cover. When the cover is opened ② a light comes on.

The lamp goes out when the vanity mirror cover is closed or the sun visor is pushed back up.

⚠ WARNING

Folded sun blinds can reduce visibility.

- Always store sun blinds and visors in their housing when not in use.

i Note

The light above the sun visor automatically switches off after a few minutes in certain conditions. This prevents the battery from discharging.

Air conditioning

Heating, ventilation and cooling

Introduction

Depending on the vehicle's equipment, several systems may have been fitted:

- The **heating and ventilation** heats and ventilates the vehicle interior. It cannot cool.
- The **manual air conditioning system** heats, cools and dehumidifies the air.
- The **Climatronic** is an automatic air conditioner that heats, cools and dehumidifies the air.

With the Climatronic's automatic mode it is possible to automatically regulate the air temperature, distribution and flow to achieve optimal thermal comfort.

To switch a specific function on, press the appropriate button. Press the button again to switch off the function.

The illuminated LEDs next to the buttons indicate that the function is switched on.

Economic use of the air conditioning

When the air conditioning is switched on, the compressor consumes engine power and has influence on fuel consumption.

The air conditioner operates most effectively with the windows closed. However, if the vehicle interior has become excessively hot due to being exposed to the sun, it will cool down faster if you open the windows for a moment.

Dust and pollen filter

The dust and pollen filter with its activated charcoal cartridge serves as a barrier against impurities in the air being carried into the vehicle interior.

The dust and pollen filter must be changed regularly so that air conditioner performance is not adversely affected.

If the filter loses efficiency prematurely due to use in areas with very high levels of air pollution, the filter must be changed more frequently than stated in the Service Schedule.

Air vents

To ensure proper heating, cooling and ventilation in the vehicle interior, the air vents must remain open.

There are other additional, non-adjustable air vents in the dash panel, in the footwells and in the rear area of the vehicle interior.

WARNING

Reduced visibility through the windows increases the risk of serious accidents.

- Always ensure that all windows are free of ice and snow, and that they are not fogged, so as to maintain good visibility of everything outside.
- Only drive when you have good visibility.
- Always ensure that you use the air conditioner and heated rear window to maintain good visibility.
- Never leave the air recirculation on for a long period of time. If the cooling system is switched off and air recirculation mode switched on, the windows can mist over very quickly, considerably limiting visibility.
- Switch air recirculation mode off when it is not required.

NOTICE

Food, medicines and other objects sensitive to heat or cold may be damaged or made unsuitable for use by the air coming from the vents.

- Never place food, medicines or other temperature-sensitive objects close to the air vents.

 Note

- When the cooling system is turned off, air coming from the outside will not be dried. To prevent fogging of the windows, SEAT recommends leaving the cooling system turned on. To do this, press the function button **A/C**. The icon should light up.
- The maximum heat output required to defrost windows as quickly as possible is only available when the engine has reached its normal running temperature.
- Keep the air intake slots in front of the windscreen free of snow, ice and leaves to ensure heating and cooling are not impaired, and to prevent the windows from misting over.
- The air from the vents flows through the vehicle interior and is extracted through slots in the luggage compartment designed for this purpose. Therefore, you should avoid obstructing these slots with any kind of object.
- It is advisable to turn on the air conditioning at least once a month, to lubricate the system gaskets and prevent leaks. If a decrease in the cooling capacity is detected, a Technical Service should be consulted to check the system.
- When the engine is under extreme strain, switch off the compressor for a moment.

Climatronic controls and functions



Fig. 78 On the centre console: Climatronic controls.

Temperature ① / ②


The temperature of the right and left sides can be adjusted separately using the adjusters. The selected temperature is shown on the the climate control panel display.


SYNC Synchronizes the driver's temperature settings to the passenger side. Activates the temperature regulator for the passenger side to set a different temperature.

AUTO In this mode, the system automatically regulates the interior temperature, fan speed and air distribution for optimal thermal comfort. The **AUTO** mode will deactivate as soon as manual changes are made to the fan speed, air distribution, windscreen demisting or air recirculation.


A/C Switches the cooling system on or off. The cooling mode cools and dehumidifies the air.

 Adjust the fan power.

 The defrost/demisting function removes ice and fog from the windscreen. The air is dehumidified and the fan is set to high.

 The heated rear window only works when the engine is running and switches off automatically after a maximum of 10 minutes. It should be switched off as soon as the glass is demisted. Lower electricity consumption has a positive effect on fuel consumption. To avoid possible damage to the battery, the automatic temporary disconnection of this function is possible, and it comes back on when normal operating conditions are re-established.




 Switches the air recirculation mode on and off »» page 106.

 Switches seat heating on and off »» page 106.

OFF Switch off the air conditioning system. If the fan is manually set to **0**, it also switches off.

Air distribution

The air flow is automatically adjusted in a comfortable way. It can also be manually distributed to the desired zone by pressing the corresponding button:

-  The airflow is directed towards the chest
-  The airflow is directed towards the footwell.
-  The airflow is directed at the windscreen.

Manual air conditioning controls / Heating and fresh air system

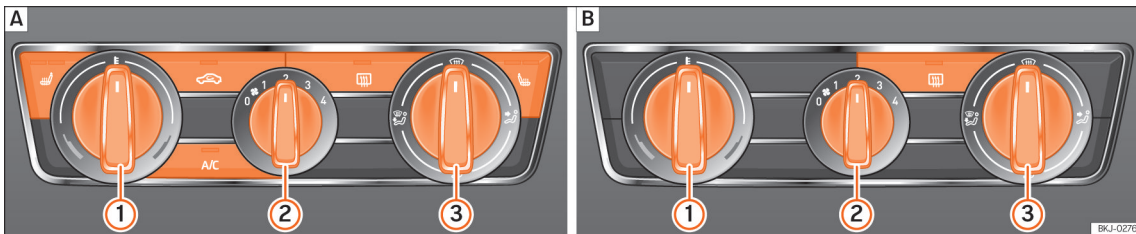


Fig. 79 In the centre console: **A** controls for the manual air conditioning; **B** heating and fresh air system controls.

Cooling mode A/C

Manual air conditioning: Press the button to switch the cooling system on or off.

Temperature ①

Turn the control to adjust the temperature.

Heating and fresh air system: The temperature cannot be lower than that of the exterior air temperature, as this system cannot cool or dehumidify the air.

Fan

Turning the regulator ② sets the fan power.

At level 0 the fan and manual air conditioning are disconnected. Level 4 is the maximum.

Air distribution

Turning regulator ③ distributes the air to the desired zone:

- The airflow is directed towards the chest
- The airflow is directed towards the footwell.
- The airflow is directed towards the windscreen and the footwell area.

Defrost/demist function

Manual air conditioning: When the control ③ is in position the air flow is directed at the windscreen and air recirculation is disconnected automatically or not activated. Increase the fan power to clear the windscreen of condensation as soon as possible. To dehumidify the air, the cooling system will automatically switch on.

Rear window heating

This only works when the engine is running and switches off automatically after a maximum of 10 minutes.

It should be switched off as soon as the glass is demisted. Lower electricity consumption has a positive effect on fuel consumption.

To avoid possible damage to the battery, the automatic temporary disconnection of this function is possible, and it comes back on when normal operating conditions are re-established.

Air recirculation

>>> page 106

Seat heating

>>> page 106

Air recirculation


Air recirculation mode prevents the ambient air from entering the interior.

When the outside temperature is very high, you can select air recirculation for a short period of time to refresh the vehicle interior more quickly.

For safety reasons, air recirculation is switched off in the following situations:

- When the button  is pressed or the air distributor is turned to .

Switching air recirculation on and off

- Press the  button to switch air recirculation on or off.

WARNING

Stuffy or stale air will increase fatigue and reduce driver concentration possibly resulting in a serious accident.

- **Never leave the fresh air fan turned off or use the air recirculation for long periods of time; the air in the vehicle interior will not be refreshed.**

NOTICE

In vehicles with an air conditioner, do not smoke when air recirculation is switched on. The smoke may be deposited on the cooling evaporator and on the active combination filter and cause permanent unpleasant odours.







Note

When the outside temperature is very high, briefly switching on the air recirculation mode helps to cool the vehicle interior more quickly.

Seat heating

The front seats have three levels of electric heating.

Controlling seat heating

- Press  or  on the control panel to turn on the seat heating at maximum power.
- Press the  or  button repeatedly to adjust it to the required level.
- To turn off seat heating, press  or  several times until no LEDs are lit.

If the ignition is switched on again in approx. the next 10 minutes, the driver seat heating is automatically turned on to the level set the last time.

Cases in which heat seating should not be switched on

Do not switch seat heating on if any of the following conditions are met:

- The seat is occupied by a person with limited perception of pain or temperature.
- The seat is not occupied.
- The seat has a cover.
- A child seat has been installed on the seat.
- The seat cushion is wet or damp.
- The outdoor or indoor temperature is higher than +25°C (77°F).

WARNING

People who cannot perceive pain or temperature because of medications, paralysis or chronic diseases (e.g. diabetes) or have a limited perception of these, may suffer burns to the back, buttocks or legs when using seat heating.

- **People with limited pain and temperature thresholds must never use seat heating.**
- **If an abnormality in the device's temperature control is detected, have it checked by a specialist workshop.**

WARNING

If the fabric of the cushion is wet, this can adversely affect the operation of the seat heating, increasing the risk of burns.

- Make sure the seat cushion is dry prior to using the seat heater.
- Do not sit on the seat with clothing that is wet or damp.
- Do not leave clothing that is wet or damp on the seat.
- Do not spill liquids on the seat.

NOTICE

- To avoid damaging the heating elements of the seat heaters, do not kneel on the seat or apply sharp pressure to a single point on the seat cushion or backrest.
- Liquids, sharp objects and insulating materials (e.g. covers or child seats) can damage the seat heating.
- In the event of odours, switch off seat heating immediately and have it inspected by a specialised workshop.
- If the original seat upholstery is replaced by another material, seat heating may overheat or its operation may be limited.

For the sake of the environment

Seat heating should remain on only when needed. Otherwise, it is unnecessary energy consumption.

Troubleshooting

The cooling system cannot be switched on or its operation is limited

If the air conditioning system cannot be switched on, this may be caused by the following:

- The engine is not running.
- The fan is switched off.
- The air conditioner fuse has blown.
- The outside temperature is lower than approximately 0°C (+32°F).
- The air conditioner compressor has been temporarily switched off because the engine coolant temperature is too high.
- Another fault in the vehicle. Have the air conditioner checked by a specialised workshop.

The heating and fresh air system cannot be switched on or operates in a limited way


- The heating and fresh air system and the defrost function operate best when the engine is hot.
- If the fault continues, consult a specialised workshop.

The windows are misted up

Windows mist up when they are cooler than the ambient temperature and the air is very damp. Cold air can absorb less moisture than hot air, so the windows mist up more often in cold weather.

- The air vent in front of the windscreen keeps it free of ice, snow and leaves, which improves the performance of the heating and cooling systems.
- The air grooves located at the rear of the luggage compartment must be kept clear to allow the air to circulate through the vehicle from front to back.
- Switch on the demist function.

Change the temperature unit (Climatronic)

The temperature display can be changed from Celsius to Fahrenheit on the Infotainment System display using the function button  > **Settings** > **Units**.

Water or water vapour under the vehicle

If the humidity and temperature outside the vehicle are high, **condensation** can drip off the evaporator in the cooling system and form a pool underneath the vehicle. This is normal and does not indicate a leak!


Note

After starting the engine, any residual humidity in the air conditioner could mist over the windscreen. Switch on the defrost function as soon as possible to clear the windscreen of condensation.

Driving

Driving indications

Pedals

- Make sure that you can always press the pedals without any problems.
- Ensure that the pedals can return unimpaired to their initial positions.
- Ensure that the floor mats are securely fastened during the trip and do not obstruct the pedals >>> .

Only use floor mats which leave the pedals clear and which are secured to prevent them from slipping. You can obtain suitable floor mats from a specialised dealership. Fasteners for floor mats are fitted in the footwells.

Wear suitable footwear

Always wear shoes which support your feet properly and give you a good feeling for the pedals.

WARNING

- Restricting pedal operation can lead to critical situations while driving.
- Never lay or fit floor mats or other floor coverings over the original floor mats. This would reduce the pedal area and could obstruct the pedals. Risk of accident.

- Never place objects in the driver footwell. An object could move into the pedal area and impair pedal operation.

Selecting the optimal gear

Depending on the equipment on the instrument cluster display, a recommendation is shown with the gear that should be engaged to optimise consumption.

On vehicles with *automatic transmission*, it is only displayed when driving in Tiptronic mode >>> page 123.

No recommendation will appear if the optimal gear is engaged. The current gear will be displayed.

Display	Meaning
3	Optimum gear.
4 ▶ 5	Changing to a higher gear is recommended.
2 ▶ 1	Changing to a lower gear is recommended.

Information regarding the “cleanliness” of the particulate filter

When the exhaust system detects that the particulate filter is close to saturation, this system's self-cleaning function recommends the optimal gear for that function >>> page 249.

WARNING

The gear change recommendation is an auxiliary function and in no case should be a substitute for careful driving.

- Responsibility for selecting the correct gear, depending on the circumstances, rests solely with the driver.

For the sake of the environment

Selecting the correct gear can help to save fuel.

Note

The recommended gear display turns off when you are no longer in tiptronic mode.

Economical and environmentally friendly driving

Fuel consumption, environmental pollution and wear to the engine, brakes and tyres all depend largely on driving style. Consumption can be reduced between 10-15% with an efficient driving style. The following section gives you some tips on lessening the impact on the environment and reducing your operating costs at the same time.

Active cylinder management (ACT®)

Depending on vehicle equipment, the active cylinder management (ACT®) may deactivate some of the engine cylinders if the driving situation does not require too much power. The number of active cylinders can be seen on the instrument panel display »» page 16.

Foresight when driving

If you think ahead when driving, you will need to brake less and thus accelerate less. Take advantage of the inertia of the vehicle whenever possible, with a **gear engaged**. This takes advantage of the engine braking effect, reducing wear on the brakes and tyres. Emissions and fuel consumption will drop to zero.

Changing gear to save energy

An effective way of saving is to change *in advance* to a higher gear.

Manual gearbox: change from first to second gear as soon as possible. Choosing the correct gear saves fuel. Select the highest possible gear suitable for the driving situation (the engine should continue to run with cyclical regularity).

Automatic transmission: accelerate gradually and without reaching the “kick-down” position.

Avoid driving at high speed

Avoid travelling at your vehicle's top speed, whenever possible. Fuel consumption, emission of harmful gases and noise pollution multiply as speed is increased. Driving at moderate speeds will help to save fuel.

Reduce idling time

In vehicles with the Start-Stop system idling is automatically reduced. In vehicles without the Start-Stop system it is worth switching off the engine, for example, at level crossings and at traffic lights that remain red for long periods of time. When an engine has reached operating temperature, and depending on the cylinder capacity, keeping it switched off for a minimum of about 5 seconds already saves more than the amount of fuel necessary for restarting.

The engine takes a long time to warm up when it is idling. Mechanical wear and pollutant emissions are also especially high during this initial warm-up phase. It is therefore best to drive off immediately after starting the engine. Avoid running the engine at high speed.

Regular maintenance

Regular servicing helps in saving fuel even before the engine is started. A well-serviced engine gives you the benefit of **improved fuel efficiency** as well as maximum reliability and an enhanced resale value. A badly serviced engine can consume up to 10% more fuel than necessary.

Avoid short journeys

The engine and catalytic converter need to reach their optimal **operating temperature** in order to minimise fuel consumption and emissions.

A cold engine consumes a disproportionate amount of fuel. The engine reaches its working temperature after about four kilometres (2.5 miles), when fuel consumption will return to a normal level.

Check tyre pressure

Always make sure the tyres are inflated to the correct pressures »» page 287 to save fuel. If the pressure is below half bar, fuel consumption may increase by 5%. Due to the greater rolling resistance, under-inflation also increases tyre wear and impairs handling.

Do not use winter tyres all year round as they increase fuel consumption by up to 10%.

Avoid carrying unnecessary loads

Given that every kilo of extra **weight** will increase the fuel consumption, it is advisable make sure that no unnecessary loads are being transported.

Since the luggage rack increases the **aerodynamic drag** of the vehicle, you should remove it when not needed. At speeds of 100-120 km/h (62-75 mph), this will achieve fuel savings of 12%.

Save electrical energy

The engine drives the alternator, thereby generating electricity. This implies that any increase in power consumption also increases fuel consumption! For this reason, switch off any unneeded electrical devices. Devices that use a lot of electricity include the blower at a high setting, the rear window heating or the seat heating.

Note

- If you have the Start-Stop system, it is recommended that it should not be disconnected.
- It is recommended that you close the windows when driving at more than 60 km/h (37 mph).
- Do not drive with your foot resting on the clutch pedal, as the pressure can make the plate slip. This causes wear and can damage the clutch plate.
- Do not ride the clutch on a hill, use the brake. The fuel consumption will be lower and you will prevent the clutch plate from being damaged.
- Use the engine brake on downhill by changing to the gear that is best suited for the gradient. Fuel consumption will be "zero" and the brakes will not suffer.

Driving with a loaded vehicle

In order to achieve appropriate driving characteristics when the vehicle is loaded, please note the following:

- Place all luggage securely >>> page 227.
- Accelerate with particular care and precaution.
- Avoid sharp braking and sudden manoeuvres.
- Brake earlier than usual.
- If applicable, please note the information about the roof rack >>> page 230.

WARNING

Loads that move around could seriously endanger the vehicle's stability and safety, extend the braking distance during hard or emergency braking and lead to serious accidents and injuries.

- Secure the load correctly to prevent it from moving around.
- Secure heavy objects with suitable lashing straps or tie-down belts.
- Ensure that the rear seat backrests are securely engaged.

Driving with the rear lid open

Driving with the rear lid open is particularly dangerous. Secure all objects and the open rear lid correctly and take any necessary measures.

Driving with the rear lid open increases the aerodynamic drag of the vehicle, along with fuel consumption. It is therefore recommended that you do not drive with the rear lid open.

WARNING

Driving with the rear lid unlocked or open can cause serious injury.

- Always drive with the rear lid closed.
- Place all objects securely inside the luggage compartment. Otherwise, loose objects could fall out of the luggage compartment and injure road users driving behind.
- Always drive carefully and with special care and anticipation.
- Avoid braking and sudden manoeuvres, as the open rear lid could move uncontrollably.
- When transporting objects that protrude from the luggage compartment, mark them accordingly to warn other road users. Please bear in mind all legal provisions.
- Never use the rear lid to support or secure objects protruding from the luggage compartment.

- If a luggage rack is fitted on the rear lid, remove it and the load when you have to drive with the rear lid open.

NOTICE

An open rear lid changes the height and, in some cases, the length of the vehicle.

Note

Depending on the country, it may be forbidden to drive with the rear lid open. Please observe the legal regulations of the country in question.

Driving on flooded roads

To prevent damage to the vehicle driving on flooded roads, take the following into account:

- Water should **never** come above the lower edge of the bodywork.
- Drive at pedestrian speed.
- Never stop the vehicle in the water, drive in reverse or stop the engine.
- Vehicles driving in the opposite direction form waves that can raise the water level so high that your vehicle will not be able to cross the water safely.

WARNING

After driving through flooded zones, braking effectiveness can decrease if the brake discs or pads are damp >>> page 130.

Note

- Driving through flooded areas may severely damage vehicle components such as the engine, drive train or electrical system.
- Avoid driving through salt water (corrosion) >>> page 305.
- Whenever driving through water, the Start-Stop system must be switched off >>> page 118.

Running in

Please observe the instructions for running-in new components.

Running-in the engine

A new engine must be driven through a run-in period during its first 1500 kilometres (1000 miles). During its first few hours of running, the internal friction in the engine is greater than later on when all the moving parts have bedded down.

How the vehicle is driven for the first 1500 km (1000 miles) influences the future engine performance. Throughout the life of the vehicle, it should be driven at a moderate speed (espe-

cially when the engine is cold) to reduce engine wear and increase its useful life. Never drive at extremely low engine speeds. Always engage a lower gear when the engine works "irregularly". **For the first 1000 km or 600 miles, please note:**

- Do not use full throttle.
- Do not force the engine above two thirds of its maximum speed.
- Do not tow a trailer.

Between 1000 and 1500 kilometres (600 to 1000 miles), gradually increase power until reaching the maximum speed and high engine speeds.

Running in new tyres and brake pads

- Replacement of wheel rims and new tyres >>> page 286.
- Information about brakes >>> page 130.



For the sake of the environment

If the engine is run in gently, the life of the engine will be increased and the engine oil consumption reduced.

Off-roader?

Your SEAT vehicle is not an off-roader: in fact, the ground clearance is not enough to be used as such. Avoid consequently rough tracks and uneven terrain.

Trips abroad

The vehicle has been manufactured for a specific country and meets the approval regulations in force in that country at the time it was manufactured.

If you are going to use the vehicle abroad temporarily or for a short period of time, please observe the relevant instructions.

Some countries have special safety regulations and provisions that the vehicle may not comply with. Before travelling abroad, SEAT recommends that you seek information from one of your dealers about the legal provisions in force in your destination country.

If you are going to sell the vehicle in another country or use it there for a longer period of time, please observe the legal regulations in force in the country in question.

In some cases it may be necessary to install or remove certain equipment at a later date, and to deactivate certain functions. Sets and types of services may also be affected. In particular, this can occur if the vehicle is to be used in another climatic region for a long period of time.

Due to the different frequency bands around the world, the factory-fitted infotainment system may not work in another country.

With petrol vehicles, it should be ensured that lead-free petrol is available throughout the journey. Seek information about service station networks selling unleaded fuel.

SEAT importers and distributors will provide information about the technical preparation that your vehicle requires and also about necessary maintenance and repair possibilities.

WARNING

As altitude increases, air density decreases. Due to the reduced air density, engine performance may be reduced and vehicle components may be damaged during prolonged operation at very high altitudes. Reduced engine power can lead to accidents and serious or fatal injuries, e.g. when overtaking.

- Before travelling abroad, especially at altitudes above 3,000 m [approx. 9,843 ft] above sea level, please contact a SEAT dealer for more information.

NOTICE

SEAT does not accept liability for any damage to the vehicle due to the use of a lower quality fuel, an inadequate service or the non-availability of genuine spare parts.

Starting and stopping the engine.

Ignition lock

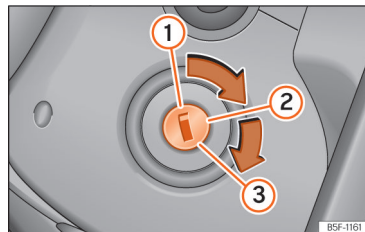


Fig. 80 Ignition lock

Key positions:

- ① Ignition off. The key can be removed from the vehicle.
- ② Ignition is switched on.
- ③ Starting the engine.

Locking and unlocking the steering wheel

- Lock the steering wheel: remove the key from the ignition and turn the wheel until it locks. Depending on the country, in vehicles with automatic transmission, in order to remove the key, move the gear shift to the **P** position. If necessary, press the gear shift locking button and release it.

- Unlock the steering wheel: put the key into the ignition and turn it at the same time as the steering wheel in the direction indicated by the arrow. If it is not possible to turn the steering wheel, it may be because it is locked.

Start-Stop system

If the vehicle is stopped and the Start-Stop system switches off the engine, the ignition remains switched on.

Automatic transmission: before leaving the vehicle, make sure that the ignition is switched off and the selector lever is in position **P**.

⚠ WARNING

- Always remove the key from the ignition when leaving the vehicle, even if only for a short period. This is especially important if children or disabled people are left alone in the vehicle. They could accidentally start the engine or operate electrical equipment, resulting in an accident.
- The ignition key must **NOT** be removed from the lock until the vehicle comes to a standstill. Otherwise, the steering could be immediately locked, causing an accident risk.

ⓘ NOTICE

Always remove the ignition key when leaving the vehicle, as it may discharge the battery if it is kept in for a long period of time.

ⓘ Note

- If it is difficult to turn the ignition key to the position ②, move the steering wheel to both sides to release the steering lock.
- If the vehicle battery is disconnected and reconnected, the key must remain in the position ② for around 5 seconds before starting up.
- *Vehicles with automatic transmission:* depending on the country, after switching off the ignition, you can only remove the ignition key if the selector lever is in position **P** (parking lock). Next, the selector lever is locked.

Switching the ignition on/off



Fig. 81 In the lower part of the centre console: start button.

The engine can be started with a start button (Press & Drive). To do so, there must be a valid key inside the vehicle in the area of the front or rear seats, or on the centre console.

In vehicles with the Keyless Access system, the engine can also be started with the key in the luggage compartment.

Opening the driver's door **when exiting the vehicle** activates the electronic lock on the steering column if the ignition is disabled.


Switching the ignition on/off

If you only want to switch on the ignition (without starting the engine):

- *Vehicles with a manual gearbox:* briefly press the start button once **without pressing** the brake or clutch pedal.
- *Vehicles with automatic gearbox:* briefly press the start button once **without pressing** the brake pedal.

The starter button text **START ENGINE STOP** flashes like a heartbeat when the system is preset for switching the ignition on and off.

Automatic ignition disconnection

If the driver leaves the vehicle, taking the key with them but leaving the ignition on, the ignition does not switch off automatically. The ignition is switched off by pressing the lock button on the remote control  or by pressing the sensor surface on the door lever. >>> page 68

Automatic deactivation of the ignition on vehicles with the Start-Stop system

The ignition is switched off automatically when the vehicle is stopped and the automatic engine shutdown is active, if:

- the driver's seat belt is not fastened,
- the driver does not step on any pedal,
- the driver door is opened.

After automatically turning off the ignition, if the dipped beam D is on, the side light remains on for approx. 30 minutes (if the battery has enough charge). If the driver locks the vehicle or manually turns off the light, the side light goes out.

Engine restart feature

If no key is detected inside the vehicle after the engine stops, you will only have 5 seconds to restart it. A warning will display on the dash panel screen.

After this interval, it will not be possible to start the engine without a valid key inside the vehicle.

Function "My Beat"

For vehicles with a convenience key there is the "My Beat" function. This feature provides an additional indication of the vehicle ignition system.

When entering the vehicle, the start button \ggg **Fig. 81** flashes to draw attention to it.

When the ignition is on/off, the engine start button flashes.

With the ignition is switched off, the start button goes off after a few seconds.

With the engine running, the start button light stays on, indicating that the engine is running. The time elapsed between the moment the user starts the engine with the start button and the lighting changes from flashing to fixed will depend on specific engine size characteristics. When the start button is used to stop the engine, the button starts flashing again.

In vehicles **with the Start-Stop system**, the "My Beat" function also offers additional information:

- When the engine stops during the Stop phase, the light of the start button stays on, as the Start-Stop system remains active even though the engine is off.
- When the engine cannot be started again with the Start-Stop system \ggg page 118 and needs to be started manually, the start button flashes to indicate this situation.

WARNING

When switching on the ignition, do not press the brake or clutch pedal, otherwise the engine could start immediately.

WARNING

If vehicle keys are used negligently or without due care, this may cause accidents and serious injury.

- Never leave any key inside the vehicle when you leave it. Otherwise, a child or unauthorised person could lock the vehicle, start the engine or connect the ignition and operate any of the electrical equipment.

Note

- Before leaving the vehicle, always disconnect the ignition and, if appropriate, take into account the instructions on the screen of the dash panel.
- If the vehicle is stationary for a long time with the engine off and the ignition on, the vehicle battery might be discharged and it might not be possible to start the engine.
- If during the STOP phase you press the START ENGINE STOP button, the ignition is switched off and the push-button flashes.
- If the following indication appears on the instrument cluster display: "Start-Stop system deactivated: Start the engine manually"; the button START ENGINE STOP will flash.

Starting the engine

Before starting the engine

- *Vehicles with manual gearboxes:* put the gear lever in neutral, press the clutch pedal and keep it in this position until the engine starts.
- *Vehicles with automatic transmission:* put the lever in position **P** or **N**.

Vehicles with ignition locks

- Turn the key to position >>> **Fig. 80 ②**.
- Keep turning the key to position >>> **Fig. 80 ③** without pressing the accelerator.
- Once the engine starts, release the key. When it is released, the key returns to position **②**.
- If the engine does not start, stop and wait for around 1 minute to try again.

Vehicles with start buttons

- Press and hold the brake pedal until the engine starts.
- Press the start button >>> **Fig. 81** without pressing the accelerator. There must be a valid key in the vehicle for the engine to start. After starting the engine, the lighting of the **START ENGINE STOP** button changes to permanently on to indicate that the engine is running.
- Once the engine starts, release the start button.

- If the engine does not start, stop and wait for around 1 minute to try again. If necessary, perform an emergency start >>> **page 118**.

WARNING

Do not keep the engine running in confined spaces, as there is a danger of poisoning.

- The exhaust gases contain carbon monoxide, an odourless and colourless poisonous gas that can cause loss of consciousness and death.

WARNING

Do not get out of the vehicle with the engine running, especially if a gear is engaged. The vehicle could then suddenly move or something strange could happen that would cause damage, fire or serious injury.

WARNING

Never use cold start sprays, they could explode or cause the engine to run at high revs. Doing this risks injury.

NOTICE

- The starter motor or the engine may be damaged if you try to start the engine while driving or if you restart it immediately after switching it off.
- When the engine is cold, you should avoid high engine speeds, driving at full throttle and over-loading the engine. Risk of engine damage.


For the sake of the environment

Do not warm-up the engine by running the engine with the vehicle stationary. Start off immediately, driving gently. This helps the engine reach operating temperature faster and reduces emissions.

Note

- Electrical components with a high power consumption are switched off temporarily when the engine starts.
- When starting with a cold engine, noise levels may briefly increase. This is quite normal, and no cause for concern.

Turning off the engine

- Bring the vehicle to a full stop >>> .
- With manual transmission, press the clutch all the way down. If the vehicle is automatic, set the selector lever to the **P** position.

- Apply the parking brake.
- *Vehicles with ignition locks:* Turn the key to position >>> **Fig. 80 ①**.
- *Vehicles with start buttons:* Briefly press the start button >>> **Fig. 80**.

Emergency shutdown

If the engine does not switch off after briefly pressing the start button, an emergency shutdown must be carried out:

- Press the start button twice within 3 seconds or press it once for more than 1 second .

WARNING

Never switch off the engine while the vehicle is in motion. This could cause loss of control of the vehicle, accidents and serious injury.

- The airbags and seatbelt pretensioners do not work when the ignition is switched off.
- The brake servo does not work when the engine is switched off. Therefore, when the engine is switched off, the brake pedal has to be pressed harder to stop the vehicle.
- The power steering does not work when the engine is switched off. When the engine is switched off, more force is required to turn the steering wheel.
- If the ignition is switched off, the steering column lock may activate, leaving the vehicle impossible to control.

- **Never remove the key from the ignition while the vehicle is in motion. This could lock the steering and make it impossible to control the vehicle. Accident risk!**

WARNING

Always take the key with you when leaving the vehicle. This is particularly important if there are children in the vehicle, as they might otherwise be able to start the engine or use power-operated equipment (e.g. the power windows), which could cause injuries.

NOTICE

- **If the vehicle is stopped and the Start-Stop system switches off the engine, the ignition remains switched on. Before leaving the vehicle, make sure that the ignition is switched off, otherwise the battery will discharge.**
- **If the vehicle has been driven at high engine speed for a long period of time, the engine may overheat when switched off. To avoid damaging the engine, let it run for about two minutes in neutral before stopping it.**

Note

After stopping the engine, the radiator fan may continue to run for up to 10 minutes, even with the ignition switched off. It may also start up again if the coolant temperature rises due to heat building-up under the

engine compartment or if the engine gets even hotter due to prolonged exposure to sunlight.

Electronic immobilizer

The electronic immobiliser helps to prevent the engine from being started with an unauthorised key and, consequently, the vehicle being put in motion.

The vehicle key has an integrated chip which automatically deactivates the electronic immobiliser if there is a valid key inside the vehicle interior.

The electronic immobiliser is automatically activated when there is no longer a valid key inside the vehicle.

For this reason, the engine can only be started with a properly coded Original SEAT key. This type of keys can be purchased from a SEAT dealer.

NOTICE

A perfect operation of the vehicle is ensured if genuine SEAT keys are used.

Emergency starting function



Fig. 82 On the right of the steering column: emergency start.

If no valid key is detected inside the vehicle, an emergency start-up will be required. The relevant message will appear in the dash panel display. This may happen when, for example, the vehicle key battery is very low.

- Immediately after pushing the starter button, keep the key next to the right trim of the steering column »» Fig. 82, as close as possible to the Kessy logo.
- The ignition connects and the engine starts automatically.

Start-Stop system

Description and operation



The Start-Stop system helps you to save fuel and reduce CO₂ emissions.

In Start-Stop mode, the engine will automatically switch off when the vehicle stops or is stopping. The ignition remains switched on. The engine automatically switches back on when required.

In this scenario, the light of the START ENGINE STOP button remains lit.¹⁾

When the ignition is switched on, the Start-Stop function is automatically activated.

Indicator lamps

-  The Start-Stop system is available, the automatic engine shutdown is active.
-  The Start-Stop system is not available or has been disconnected.

Stopping and starting the engine

Vehicles with a manual gearbox:

- When the vehicle is stopped, put it into neutral and release the clutch pedal. The engine will stop. The warning lamp (A) will light up on

the display. The engine may be stopped before the vehicle comes to a standstill (approximately 7 km/h).

- When you depress the clutch pedal, the engine will start again. The indicator lamp goes out.

Vehicles with an automatic gearbox:

- Brake until the vehicle stops and keep your foot on the brake pedal. The engine will stop. The warning lamp (A) will appear on the display. The engine can be stopped before stopping completely (approximately 7 or 2 km/h depending on the vehicle's gearbox).
- When you take your foot off the brake pedal the engine will start up again. The indicator lamp goes out.


Basic requirements for the start/stop mode



- The driver door must be closed.
- The driver's seat belt must be fastened.
- The bonnet must be closed.
- The engine has reached operating temperature.
- The reverse gear must not be engaged.
- The vehicle must not be on a very steep slope.

¹⁾ Only in vehicles with Keyless Access.

The engine does not turn off for various reasons


Before stopping the vehicle, the system verifies whether certain conditions are met. The engine **does not** switch off, in the following situations for example:

- The engine has not yet reached the required temperature for the Start-Stop mode.
- The temperature selected on the climate control has not been reached.
- If maximum (HI) or minimum (LO) temperature is requested in the air conditioner.
- De-icing function button  activated.
- Park assist is switched on.
- The battery is very low.
- The steering wheel is overly turned or is being turned.
- If there is a danger of misting.
- After engaging reverse gear.
- In case of a very steep gradient.

 is displayed on the instrument cluster screen; it is also displayed in the driver information system, START  STOP.

The engine starts by itself

When stopped, the normal system mode may be interrupted in the following situations. The engine restarts without the driver's intervention.

- The interior temperature differs from the temperature selected on the climate control.
- Defrost function button activated .
- The brake is pressed several times in a row.
- The battery is not charged enough.
- High electricity consumption.

Additional information related to the automatic gearbox

The engine stops when the selector lever is in **D**, **N** and **S**, as well as in Tiptronic mode. With the selector lever in **P**, the engine will also remain switched off when you take your foot off the brake pedal.

In order to start the engine up again the accelerator must be pressed, or another gear engaged or the brake released.

If the selector lever is placed in **R** while stopped, the engine will start up again.

Change from **D** to **P** to prevent the engine from accidentally starting when passing through **R**.

Additional information about vehicles with Adaptive Cruise Control (ACC)

In vehicles with ACC function, the engine will start up again in certain operating conditions if the radar sensor detects that the vehicle ahead drives off again.

WARNING

- **Never switch the engine off until the vehicle is stationary. The operation of the brake and steering will not be fully guaranteed. More force will be needed to turn the steering wheel or to brake. You could suffer an accident and even serious injuries.**
- **To avoid injury, make sure that the Start-Stop system is switched off when working in the engine compartment >>> page 120.**

NOTICE

The Start-Stop system must always be switched off when driving through flooded areas >>> page 112.

Note

- **In vehicles with an automatic gearbox, you can control whether the engine should switch off or not by reducing or increasing the brake force applied. While the vehicle remains stopped, the engine will not stop if the brake pedal is slightly pressed, in traffic jams with frequent stopping and starting for example. As soon as strong pressure is applied to the brake pedal, the engine will stop.**
- **When stopped, the brake pedal must be kept pressed to ensure that the vehicle does not move.**
- **If the engine "stalls" with a manual gearbox, it can be directly started up again by immediately pressing the clutch pedal.**

- If the lever is placed in position D, N or S after engaging reverse gear, 10 km/h (6 mph) in a forwards direction must be reached for the system to be in a condition to stop the engine.

Manually connecting and disconnecting the Start-Stop system

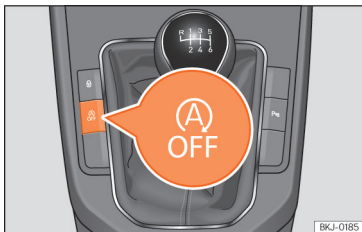



Fig. 83 Centre console: Start-Stop system button.

If you do not wish to use the system, you can switch it off manually:

- To manually switch on/off the Start-Stop system, press the  button >>> **Fig. 83**

The button symbol  remains lit up in yellow when the system is switched off.

Note

The system switches on every time the engine is turned off voluntarily.

Troubleshooting

Indications for the driver on the instrument cluster screen

"Start-Stop system deactivated. Start the engine manually"

- This indication shows that the Start-Stop system **cannot** restart the engine.

This happens for 2 reasons: if the driver's door has been opened or if the driver has unbuckled the seat belt.

"Start-Stop system: Fault! Function not available"

- There is a fault in the Start-Stop system. Take the vehicle to a workshop to have the fault repaired.

Manual gearbox

Changing gears

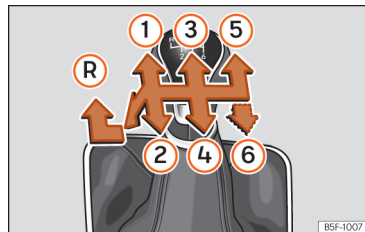


Fig. 84 Gear shift pattern of a 5 or 6-speed manual gearbox.

Gear positions are indicated on the gear lever >>> **Fig. 84.**

- Depress the clutch and keep your foot as far as it will go.
- Move the gear lever to the desired position.
- Release the clutch.

Engaging reverse gear

Only engage reverse gear when the vehicle is stopped.

- Depress the clutch and keep your foot as far as it will go.
- With the gear lever in neutral, push it down, move it all the way to the left and then forwards to select reverse gear »» Fig. 84 (R).
- Release the clutch.

Changing to lower gears

When driving, you should always change down through the gears progressively, i.e. to the gear immediately below when engine RPM is not too high »» ⚠. Skipping one or several gears when changing down through the gears at high speed or high RPM can cause damage to the clutch and gearbox, even if the clutch is depressed »» Ⓞ.

⚠ WARNING

If the engine is running, the vehicle starts moving as soon as a gear is engaged and the clutch pedal is released. This also happens if the electronic parking brake is switched on.

- Never engage reverse gear while the vehicle is in motion.

⚠ WARNING

Changing down through the gears incorrectly by selecting a gear that is too low can lead to loss of control of the vehicle and cause accidents and serious injuries.

ⓘ NOTICE

Engaging a gear that is too low when driving at high speed or at high engine RPM can cause considerable damage to the clutch and gearbox. This can happen even if the clutch pedal is kept depressed and the gear is not engaged.

ⓘ NOTICE

Consider the following to avoid damage and premature wear:

- Do not rest your hand on the gear lever while driving. The pressure exerted by the hand is transmitted to the gearbox forks.
- Do not rest your foot on the clutch pedal; even if the pressure seems insignificant, it can cause premature wear of the clutch disc. Use the footrest when not changing gears.
- Make sure the vehicle is completely stopped before engaging reverse gear.
- When changing gears, always fully depress the clutch.
- Do not "ride" the clutch with the engine running when the vehicle is stopped on an uphill slope.

DSG automatic transmission

Introduction

Your vehicle is equipped with an electronically controlled manual gearbox. Torque between the engine and the gearbox is transmitted via two independent clutches. They replace the torque converter found on conventional automatic gearboxes and allow for smooth, uninterrupted acceleration of the vehicle.

The **Tiptronic** system allows the driver to change gears *manually* »» page 123, *Changing gear in Tiptronic mode*.

Gear selector positions

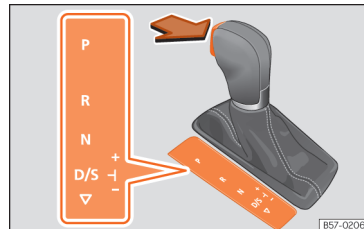



Fig. 85 Selector lever lock.


The selector lever position is shown when the corresponding sign lights up. With the selector lever in the manual gearbox positions **M**, **D** and **S**, the engaged gear is also shown on the display.

P - Parking lock

When the lever is put in this position, the drive wheels are locked. The lever should only be put in **P** when the vehicle is stationary >>> .

To put the lever in **P** or take it out of **P**, the locking button must be pressed and held and the brake pedal pressed simultaneously.


R - Reverse gear

Reverse gear must be engaged only when the vehicle is stationary and the engine is idling >>> .

To move the lever to position **R**, the lock button must be pressed and held while pressing the brake pedal at the same time. The reverse lights come on when the lever is in the **R** position with the ignition on.

N - Neutral

In this position, the gear is in neutral.

Press the brake pedal to move the lever from **N** to **D/S** when the vehicle is stationary or at speeds below 3 km/h (2 mph) >>> .

D/S - Permanent forward drive position

The lever in the **D/S** position enables the gears to be operated in normal mode (**D**) or sport mode (**S**). To select Sport mode **S**, move the lever backwards. Pushing the lever again will select normal mode **D**. The selected driving mode is shown on the instrument panel display.

In **normal mode (D)**, the gearbox selects the best gear ratio. This depends on the engine load, speed and the dynamic regulation program (DRP).

Sport mode (S) should be selected for a sporty driving style. This setting makes use of the engine's maximum power output. When accelerating, gear shifting operations are perceptible.

Under certain circumstances (e.g. on mountain roads) it can be advantageous to switch tip-tronic mode >>> **page 123**, to adapt the gears to suit the road conditions.

Selector lever lock

In **P** or **N**, the lever lock prevents a gear range from being engaged, and prevents the vehicle from moving off accidentally.

To release the gear lever lock, press and hold the brake pedal with the ignition on. At the same time, press the lever lock in the direction of the arrow >>> **Fig. 85**.

As a reminder to the driver, when the lever is in positions **P** or **N** the following indication will be shown on the screen:

When stationary, apply foot brake while selecting a gear.

The lever is not locked if it is moved quickly through position **N** (e.g. when shifting from **R** to **D**). This means, for example, that a stuck vehicle can be assisted by "swinging it". The lever lock engages automatically if the brake pedal is not pressed and the lever is in position **N** for more than about one second at a speed of less than 5 km/h (3 mph).

Ignition key removal lock

Once the ignition has been turned off, the key may be removed only if the gear selector is in position **P**. While the key is not in the ignition, the selector lever is locked in position **P**.

WARNING

- Take care not to press the accelerator pedal when the vehicle is stopped. The vehicle could start moving immediately (in some cases even if the parking brake is engaged) resulting in the risk of an accident.
- Never move the lever to **R** or **P** when driving. Failure to follow this instruction could result in an accident or failure.
- With the lever in any position (except **P**), the foot brake must be pushed down whenever the engine is running. This is because an automatic gearbox still transmits power even at idling speed.

- Do not accelerate while selecting a gear, with the car stationary and the engine running. Failure to follow this instruction could result in an accident.
- The driver must never leave the vehicle while the engine is running and with a gear engaged. Apply the parking brake and select the parking lock [P].

Note

- If the lever is moved accidentally to N when driving, release the accelerator and let the engine speed drop to idling before selecting gear range D or S again.
- Should the power supply to the lever be interrupted in position P, it will not be possible to move the lever. If this should happen the manual release can be used >>> page 126.

Note

- If the lever lock does not engage, there is a fault. The transmission is interrupted to prevent the vehicle from moving accidentally. Follow the procedure below in order for the lever lock to engage again:
 - With 6-speed gearbox: depress and release the brake pedal.
 - With 7-speed gearbox: depress the brake pedal. Move the lever to position P or N and subsequently engage a gear.

- If a gear has been selected, the vehicle does not move forwards or back. Proceed to the next mode:
 - If the vehicle does not move in the desired direction, the gear ratio may not be correctly engaged by the system. Depress the brake pedal and reselect the gear range.
 - If the vehicle still does not move in the desired direction, there is a system failure. Seek specialist help and have the system checked.

Changing gear in Tiptronic mode

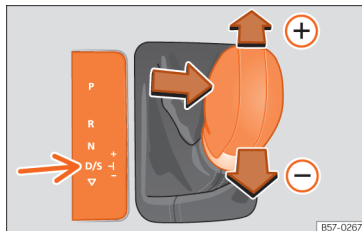


Fig. 86 Lever in the Tiptronic position

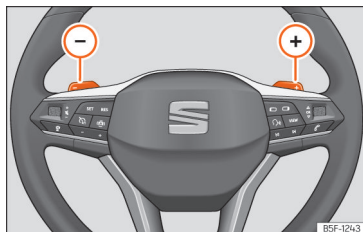


Fig. 87 Steering wheel: automatic gearbox levers

Tiptronic gives the driver the option to change gears manually.

When you change to the Tiptronic programme, the vehicle remains in the currently selected gear. This is possible as long as the system is not changing gear automatically due to a traffic situation.



Using Tiptronic with the selector lever

It is possible to change to Tiptronic mode, both when the vehicle is stopped and while driving.

- Starting from the **D/S** position, move the lever to the right. The instrument panel will show whether the lever is in manual or Tiptronic mode (e.g. **M4**).
- Move the lever forwards (+) or backwards (-) to change up or down a gear >>> **Fig. 86**.
- To exit Tiptronic mode, move the lever to the left.

Using Tiptronic with the steering wheel paddles

The gearshift paddles can be used when the selector lever is in the **D/S** or **M** (Tiptronic) positions.

- Press the  gear shift paddle to change up a gear **>>> Fig. 87.**
- Press the  gear shift paddle to change down a gear.
- To exit the Tiptronic mode, pull the right-hand lever towards the steering wheel for approximately 1 second or move the lever to the left.

If the paddles are not operated for some time and the lever is not in the Tiptronic selection position, it will automatically exit from Tiptronic mode.

NOTICE


- **When accelerating, if a higher gear is not selected, it will automatically change shortly before reaching the maximum permitted RPM.**
- **Also, if a lower gear is selected, the system will not change until it detects that the engine will not reach its maximum RPM.**

Driving with an automatic gearbox

Shifting to a higher or lower gear is automatic.


The engine can only start with the selector lever in position **P** or **N**. At low temperatures (below -10°C), the engine can only start with the selector lever in position **P**.

Driving downhill


Under certain circumstances it may be advantageous to use the Tiptronic mode to select the gear manually according to driving conditions **>>> .**


Stop/Park

On level ground, just use the lever to engage position **P**. On slopes you should first apply the parking brake and then set the lever to **P**. This makes it easier to remove the lever from position **P** when starting.

If the driver door is opened and the lever is not in position **P**, the vehicle could move. The following warning is displayed on the instrument panel:  **Gear change: Selector lever in the drive position!** A buzzing sound is also heard.

Stopping on a downhill

Always press the brake pedal firmly to prevent the vehicle from moving; if necessary, apply the parking brake **>>> .**

Do not accelerate while a range of gears is engaged to prevent the car from rolling downhill **>>> .**

Hill starts

- Apply the parking brake.
- Once you have engaged a gear, accelerate carefully and release the parking brake.


WARNING

Observe the safety warnings **>>>  in Gear selector positions on page 122.**

- **Never allow the brake to rub and do not use the brake pedal too often or for long periods, as the brakes can overheat. This reduces the braking power, increases the braking distance or even causes a brake system fault.**
- **If you have to stop on a hill, keep the vehicle's brakes applied with the brake pedal or parking brake.**


NOTICE

- **When stopping the vehicle on an uphill slope, do not try to avoid shifting into gear and depressing the accelerator. This could overheat and damage the automatic gearbox.**
- **If you allow the vehicle to roll with the lever in position **N** and the engine off, the automatic gearbox will be damaged by lack of lubrication.**

- In certain driving situations or traffic conditions, the gears could overheat and be damaged! If the warning lamp  lights up, stop the vehicle as soon as you can and wait for the gearbox to cool >>> page 126.
- If the gearbox operates in emergency mode, have the fault repaired by a specialist workshop without delay.

Kick-down

The kick-down device provides maximum acceleration when the gear selector lever is in the positions **D**, **S** or in Tiptronic mode.

When the accelerator pedal is fully depressed, the automatic transmission shifts to a lower gear, depending on speed and engine speed. This uses the vehicle's maximum acceleration >>> .

The shift to the next higher gear will not take place until the preset maximum engine RPM is reached.

WARNING

Please note that if the road surface is slippery or wet, the kickdown feature could cause the driving wheels to spin, which could result in skidding.


Inertia mode

The inertia mode allows you to travel certain distances without using the accelerator, which saves fuel. Plan ahead and use the inertia mode to let the vehicle roll.

Activation of the inertia mode

Condition: lever in position **D**, slopes of less than 12% and speeds between 20 and 130 km/h (12 and 80 mph).

- Gently take your foot off the accelerator.

The indication will be shown on the instrument panel , the engaged gear and current consumption will disappear and the word **Inertia** will appear.

The gears will automatically disengage and the vehicle will roll freely, without the effect of the engine brake. While the vehicle rolls, the engine runs at idling speed.

Stopping inertia mode

- Press the brake or the accelerator pedal.

To take advantage of the engine's inertia mode, simply remove your foot from the accelerator.

Applying both the **inertia mode** (= prolonged section with less energy) and **inertia disconnection** (= shorter section without the need for fuel) facilitates improved fuel consumption and emission balance.

If the vehicle has **SEAT Drive Profile** >>> page 129, the inertia mode can be activated in **Normal**, **Eco** and **Individual** modes. In **Eco** mode, it is activated whenever the operating conditions are met, regardless of the smoothness with which the foot is removed from the accelerator.

WARNING

- If the inertia mode has been switched on, take into account, when approaching an obstacle, that the vehicle will not decelerate in the usual manner: risk of accident!
- When using inertia mode while travelling down hills, the vehicle can increase speed: risk of accident!
- If other users drive your vehicle, warn them about inertia mode.

NOTICE

The driver message Inertia is only displayed with the current consumption. In inertia mode the gear will no longer be displayed (for example D or E will appear instead of D7 or E7).

NOTICE

The inertia mode will be automatically disconnected on gradients steeper than 15%.

Note

In the case of the 1.6l TDI engine, the inertia mode will only work with the Eco driving profile.

Troubleshooting**The engine does not start**

The indicator lamp lights up green.

The brake is not depressed, e.g. when trying to change the gear selector lever.

- To select a gear range, press the brake pedal.

Selector lever lock

The control lamp flashes green.

The selector lever locking button is not engaged. The vehicle is prevented from moving forwards. Engage the selector lever lock.

Indications on the instrument cluster display:

Clutch**Clutch overheated Please stop!**

- The clutch has overheated and could be damaged. Stop and wait for the gearbox to cool with the engine at idling speed and the selector lever in position **P**. When the warning lamp and the driver message switch off, have

the fault corrected by a specialised workshop without delay. If they do not turn off, do not continue driving. Seek specialist assistance.

Faults in the gearbox**! Gearbox: Fault! Stop the vehicle and place the lever in P**

- There is an anomaly in the gearbox. Stop the vehicle in a safe place and do not continue driving. Seek specialist assistance.

! Gearbox: System fault! You may continue driving

- Have the fault corrected by a specialised workshop without delay.

! Gearbox: System fault! You can continue driving with restrictions. Reverse gear disabled

- Take the vehicle to a specialised workshop and have the fault repaired.

! Gearbox: System fault! You can continue driving in D until switching off the engine

- Stop the vehicle in a safe place. Seek specialist assistance.

! Gearbox: too hot. Adapt your driving accordingly

- Continue driving slowly. When the warning lamp goes out, you can continue driving normally.

! Gearbox: press the brake and engage a gear again

- If the warning was caused by the temperature of the gearbox, this driver message will be displayed when the gearbox has cooled again.

Emergency mode

If all the gear positions are shown over a light background on the instrument cluster, there is a system fault and the automatic gearbox will operate with the backup programme. It is still possible to drive the vehicle, but at low speeds and within a selected range of gears. **Driving in reverse gear may not be possible.**

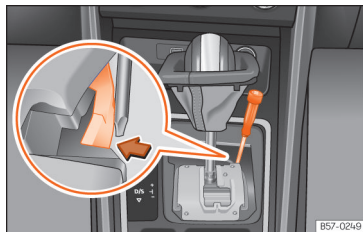

Manual release of the selector lever

Fig. 88 Selector lever: manual release in the parking position.

In the event of a power failure when starting (e.g. discharged battery), the lever will remain locked in position **P**. To move it to position **N**

to move the vehicle, there is an emergency release device under the centre console, on the right side. The release operation is not straightforward.

Removing the cover from the selector lever:

- Apply the parking brake >>> .
- Carefully pull the corners of the selector lever dust guard and twist it upwards over the lever handle.

Releasing the selector lever:

- Using the flat part of a screwdriver, press the yellow tab sideways and hold it down down >>> **Fig. 88.**
- Press the lock button on the selector lever and move it to position **N**.
- After completing the emergency release, re-attach the selector lever dust guard to the gearbox console.

WARNING

Do not move the lever from position P if the parking brake is not firmly engaged. If you still think the car could move, press the brake pedal. Danger! The vehicle could move in an unforeseen way and cause an accident or serious injury.

Driving on slopes

Hill start assist

The hill start assist helps the driver to move off and upward on a hill, both forwards and backwards, when the vehicle is stationary.

The system maintains brake pressure for approximately two seconds after the foot is taken off the brake pedal, to prevent the vehicle from moving when it is started. During these 2 seconds, the driver has enough time to release the clutch pedal and accelerate without the vehicle moving and without having to use the parking brake, making moving off easier, more comfortable and safer.

Its operating conditions are:

- vehicle on a slope,
- driver's door closed,
- vehicle at a full stop,
- engine running and brake depressed,
- having a gear engaged or in neutral for a manual gearbox, or with the selector lever at positions **D/S** or **R** for an automatic gearbox.

WARNING

- If you do not start the vehicle immediately after taking your foot off the brake pedal, the vehicle may roll back under certain conditions. Press the brake pedal or apply the parking brake immediately.
- If the engine stalls, press the brake pedal or apply the parking brake immediately.
- When following a line of traffic uphill, if you want to prevent the vehicle from rolling back when starting off, hold the brake pedal down for a few seconds beforehand.

Note

Your official service or a specialist workshop can tell you whether your vehicle is equipped with this system.

downhill assistant

Downhill speed control is activated when the gear lever is in the **D/S** position and the brake is applied. An appropriate lower gear is engaged.

The assistant attempts to maintain the speed at which the vehicle was travelling when the brake was applied, within logical limits. It may be necessary to correct the speed by pressing the brake.

The assistant can only change down as far as 3rd gear. It is possible that on very steep slopes you may have to switch to tiptronic mode and

then manually change down to 2nd or 1st gear to take advantage of engine braking and take the load off the brake system.

Downhill speed control is deactivated as soon as the road levels out again or you press the accelerator pedal.

On vehicles with a cruise control system

»» page 139, downhill speed control is activated when you set a cruising speed.

WARNING

The downhill speed control cannot defy the laws of physics. Therefore, speed cannot be kept constant in all situations. Always be prepared to use the brakes!

Steering

Information relating to different vehicle processes.

To make the vehicle more difficult to steal, all ways lock the steering before leaving the it.

Steering

On vehicles with electromechanical steering, the power steering automatically adjusts according to the driving speed, the steering wheel torque and the orientation of the wheels. The power steering only works when the engine is running.

If the power steering does not work properly or does not work at all, you will have to use much more strength than usual to turn the steering wheel.


Progressive steering

Depending on the vehicle's features, it may or may not incorporate a progressive steering system.

In *city traffic* you do not need to turn so much on parking, manoeuvring or in very tight turns.

On *roads or motorway*, progressive steering transmits, for example, in bends, a sportier, more direct and noticeably more dynamic driving sensation.

Steering assist

This help assists the driver in critical situations. It recommends turning the steering wheel to perform a corrective manoeuvre (counter-steering), turning slightly to avoid skidding »» .

WARNING


Steering assist helps the driver in critical situations. The driver is the person who has to control the vehicle's steering at all times.

Troubleshooting

Steering fault

The warning lamp lights up red.

There is a fault in the power steering.

-  **Stop driving!** Seek specialist assistance.
- Do not allow the vehicle to be towed on its own wheels.

Steering fault

The control lamp lights up or flashes yellow.

The steering is stiffer or reacts more sensitively than usual.

The control lamp **lights up and remains lit**:

- Restart the engine and drive slowly for a short distance. Contact a specialist workshop if the control lamp remains on.
- **OR:** the 12-volt battery was disconnected and reconnected. Drive slowly for a short distance.

The control lamp **flashes**:

- Turn the steering wheel slightly from one side to the other.
- Turn off the ignition and turn it on again.
- Consider the warnings shown on the instrument cluster display.
- If the control lamp continues flashing after the ignition has been switched on, do not continue driving. Seek specialist assistance.

SEAT Drive Profiles

Introduction

The driver can use the drive profiles to adapt various features of the vehicle's systems to the current driving situation, the desired driving comfort and an economical driving style. Some of the systems that can be adapted are the suspension, steering, engine and air conditioning.

Depending on the vehicle's equipment, various drive profiles can be selected. The degree of influence of the vehicle's systems on the different drive profiles depends on the vehicle's equipment.

Engine

Depending on the profile selected, the engine responds more quickly or smoothly to the accelerator being pressed.

In vehicles with automatic transmission, the gear change timing is changed to put the changes at higher or lower revolutions. The **Eco** profile activates the Inertia function, thereby reducing consumption. The rest of the driving profiles will activate the inertia use function when the selector lever is not in the **S** position, depending on how the accelerator pedal is released »» page 125. When the vehicle is turned on again, the function is activated by default to reduce consumption.

With manual transmission, the **Eco** profile changes the gear change recommendations to facilitate more efficient driving.

"Dual Ride" suspension

The "Dual Ride" suspension sets the suspension to comfortable in the **Eco** and **Normal** profiles, and to sport in the **Sport** profile. In the **Individual** profile the suspension can be switched between **Normal** or **Sport**, depending on personal preference.

In the event of a fault in the "Dual Ride" suspension, the following message is displayed on the instrument panel screen: **Fault: damping adjustment.**

Steering

Power steering becomes harder in the **Sport** profile to enable a sportier driving style.

Air conditioning

In vehicles with Climatronic, this can operate in the **Eco** profile, especially restricting fuel consumption.

Adaptive Cruise Control (ACC)

The ACC's acceleration and braking mode varies according to the driving profile »» page 143.

Selecting a drive profile



Fig. 89 Next to the gearbox lever: **MODE** button.

The drive profile can be selected when the ignition is switched on and the vehicle is stationary or moving »» **△**.

The desired profile can be selected by successively pressing the selection button »» **Fig. 89**.

Kick-down

The kick-down feature allows maximum acceleration »» page 124.


If the **Eco** profile has been selected in the SEAT Drive Profile, and the accelerator is pressed beyond a hard point, the engine power is automatically controlled to give your vehicle maximum acceleration.




⚠ WARNING

Adjusting the drive profile while driving can distract attention from traffic and cause accidents.

- Always drive with attention to traffic and in a responsible manner.

Characteristics of drive profiles


The lighting of the  button lights up and an icon on the infotainment system display informs about the active profile if it is anything other than **Normal**.

Drive profile	Characteristics
ECO	Places the vehicle in a low state of consumption, facilitating a fuel-saving driving style that is environmentally friendly.
 Normal	Offers a balanced driving experience, suitable for everyday use.
 Sport	It gives the vehicle an overall dynamic behaviour, allowing for sportier driving.
 Individual	Allows personalisation of the configuration. The functions that can be set depend on the vehicle equipment.

⚠ WARNING

Speed and driving style should always be adapted to suit visibility, weather and traffic conditions.

i Note

- Regardless of the drive profile selected when the ignition is switched off, all systems will start up with the Normal profile. Use the button  to select another drive profile.
- Speed and driving style should always be adapted to suit visibility, weather and traffic conditions.
- Use of the Eco profile is not recommended when driving with a trailer.

Braking system**Information about the brakes**

During the first 200 to 300 km, **new brake pads** do not provide maximum braking power and still have to "settle" »» ⚠. **When running in the brake pads, the emergency braking distance is longer** than after they have been run in. During the run-in, avoid sharp braking and situations that place a lot of demand on the brakes, e.g. driving too close to another vehicle.

Brake pad wear depends to a large extent on the conditions in which the vehicle is used, and driving style. If the vehicle is frequently used in city traffic and for short distances, or for sporty driving, brake pad thickness should be checked regularly at a specialist workshop.

Driving with **wet brakes**, e.g. after driving through water, in heavy rain or after washing the vehicle, braking performance may be affected by wet brake discs, or even frozen discs in winter. The driver should be ready to brake harder.

If **the brake discs and pads have a layer of salt on them**, the braking performance is reduced and the braking distance increases. When driving on salted roads without braking for some time, the layer of salt should be removed by carefully applying the brakes a few times »» ⚠.

Corrosion on the brake discs and **dirt** on the brake pads increase if the vehicle is left unused for a long time, if it is not driven for many kilometres. If corrosion is present, it is recommended to clean the discs and pads by braking hard several times while driving at high speed. Make sure that you do not endanger any other vehicles or road users »» ⚠.

⚠ WARNING

Driving with worn brake pads or a defective brake system can lead to accidents and serious injuries.

- If you suspect that the brake pads are worn or that the brake system is faulty, have the brake pads checked immediately by a specialist workshop and replaced if they are worn.

⚠ WARNING

The braking performance of new brake pads is not optimal.

- During the first 300 km, new brake pads do not provide maximum braking power and still have to “settle”. This can be counteracted by applying more pressure to the brake pedal.
- When brake pads are new, drive with extra care to reduce the risk of accidents, serious injury or loss of control of the vehicle.
- Only perform hard braking to clean the brake system when permitted by the traffic situation. Do not endanger the occupants of other vehicles. Accident hazard!
- When running in new brake pads, do not drive too close to other vehicles or cause situations that would require the brakes to be applied heavily.

⚠ WARNING

When the brakes overheat, their braking performance drops and the braking distance increases.

- When driving downhill, particular demand is placed on the brakes and they heat up very quickly.
- Before a long steep slope, reduce speed and change down into a lower gear or range. Therefore, using the engine brake relieves the brakes.
- If you wish to retrofit a front spoiler, integral trim or other accessories, ensure that the air inlet around the brakes is not reduced, as otherwise the brake system could overheat. Please also note the information on brake fluid >>> page 273.

⚠ WARNING

Wet, frozen or salt-covered brakes take longer to brake and increases the braking distance.

- Test the brakes carefully.
- Always dry the brakes and free them from ice and salt by braking repeatedly, if permitted by visibility, weather, road surface and traffic conditions.

⚠ WARNING

When braking manoeuvres are started automatically, the brake pedal may move automatically in the application direction. Do not put your foot under the brake pedal. Risk of injury!

i Note

Never let the brakes “drag” by leaving your foot on the pedal when it is not necessary to brake. This can cause the brakes to overheat, resulting in increased brake travel and wear. Please consider the important notes on brake fluid >>> page 273.

i Note

Regularly check the thickness of the brake pads visually through the holes in the rims or from the underside of the vehicle. If necessary, the wheels should be removed for a more thorough inspection. SEAT recommends visiting a SEAT dealership for this.

Troubleshooting**(!) Defect in the brake system**

The warning lamp lights up red. A message may also be displayed.

🛑 Stop driving!

- Inform a specialist workshop and request a brake system inspection.

Brake assist systems

Information relating to brake assist systems

Brake assist systems can help the driver in critical driving or braking situations. The driver is responsible for driving safely »» » ⚠.

When the brake assist systems are regulating the brakes, the brake pedal may move or make noises. Even so, continue to brake with the necessary force and control the trajectory of the vehicle if necessary.

Depending on the equipment, the ESC and TCS settings can be changed in the vehicle.

- The ESC, ABS and TCS can only operate correctly if the four wheels are fitted with the stipulated tyres »» » ⚠.
- If a fault occurs in the ABS, the ESC, TCS and EDS also cease to function.

Electronic Stability Control (ESC)

The ESC helps to reduce the risk of skidding and to improve stability in certain driving situations »» » ⚠.

Traction control (TCS)

The TCS reduces the driving force on skidding wheels and adapts this force to suit the road surface conditions. The TCS facilitates starting, acceleration and hill climbing »» » ⚠.

Electronic brake pressure distribution (EBV)

Electronic brake force distribution (EBV) regulates the braking force between the front and rear axles. Excessive braking of the rear axle is avoided and the vehicle remains stable during the braking operation.

Anti-lock braking system (ABS),

The ABS can prevent the wheels from locking up under braking until shortly before the vehicle comes to a stop, and helps the driver maintain control of the steering and the vehicle »» » ⚠.

Brake assist (BAS)

Brake assist (BAS) can help to reduce the braking distance. Brake Assist increases the pressure exerted by the driver when the brake pedal is depressed quickly in an emergency.

Electronic differential lock (EDS and XDS)

The EDS automatically brakes skidding wheels and transmits the driving force to the other driving wheels.

XDS improves traction by applying the brakes to improve cornering acceleration.

Multi-collision brake

The multi-collision brake automatically triggers braking if the airbag control unit detects a collision in the event of an accident.

Automatic braking requirements:

- The driver is not pressing the accelerator pedal.

Trailer stabilisation¹⁾

Note that the vehicle-trailer assembly generally tends to snake. When the snaking of the trailer is felt by the vehicle and detected by the ESC, it will automatically brake the towing vehicle within the limits of the system and stabilise the vehicle-trailer set »» » page 239.

⚠ WARNING

Smart brake assist technology cannot overcome the limits imposed by the laws of physics and only works within the limits of the systems. Driving at high speed on icy, slippery or wet road surfaces can cause a loss of control of the vehicle and serious injury to the driver and passengers.

¹⁾ Depending on the version.

- Adapt your speed and driving style at all times to suit visibility, weather, road and traffic conditions. Never take any risk that compromises safety.
- Brake assist systems cannot prevent an accident if you are driving too close to other vehicles.
- Always use suitable tyres. Driving stability depends on tyre grip.

WARNING

The efficiency of the ESC can be significantly reduced if components or systems that affect the driving dynamics are not properly maintained or are not working properly. This can particularly occur if changes are made to the suspension or unauthorised rim/tyre combinations are used.

- Ensure that vehicle conversions and modifications are only made by specialised workshops.
- Always use suitable tyres. Driving stability depends on tyre grip.

WARNING

When driving without a brake servo or with restricted brake servo functions, the braking distance can increase considerably and can cause accidents and serious injuries.

- If the brake servo is not working, the brake pedal has to be pressed harder, as the braking distance increases due to the lack of assistance from the servo brake.


Connecting and disconnecting the ESC and TCS

The ESC is switched on automatically when the engine is started, and only works when the engine is running and includes the ABS, EDS and TCS systems.

The TCS function should only be switched off in situations in which traction is insufficient.


Depending on the finishes and versions, there is the possibility of disconnecting only the TCS or activating the ESC in "Sport" mode.

Disconnecting and connecting the TCS

- The TCS can be turned on or off in the infotainment system using the function button  > **Driver assist > ESC Menu >>>** page 35.

When the TCS is switched off, the control lamp  lights up on the instrument cluster.

Disconnecting and connecting the ESC in "Sport" mode

- The ECS in "Sport" mode can be activated or deactivated in the infotainment system using the function button  > **Driver assistance > ESC Menu >>>** page 35.

When "Sport" mode is connected, the interventions of the ESC to stabilise the vehicle, and the traction control (TCS) interventions are limited.

WARNING


The ESC Sport mode should only be switched on if the traffic situation and the driver's ability allow it. Danger of skidding!

- With ESC in Sport mode, the stabilising function will be limited for sportier driving. The vehicle may skid.

Note

If the TCS is disconnected or "Sport" mode is selected, cruise control will be switched off.

Troubleshooting

 **The ABS does not work properly or does not work at all**

The control lamp switches on yellow.

- Contact a specialised workshop. The vehicle's brakes still work without the ABS.


The ESC or TCS is regulating

The control lamp flashes yellow.

ESC fault

The control lamp switches on yellow. The ESC has been switched off.



There is a fault or defect.

- Turn off the ignition and turn it on again.
- If possible, drive for a short distance at 15-20 km/h (9-12 mph).
- If the control lamp  is still on, go to a specialised workshop.


The brake assist systems make noises

When the described brake assist systems intervene, you may hear noises.

WARNING

- When the ignition is switched on, the status of the brake system and the brake assist functions are automatically checked. The control lamps on the instrument cluster light up briefly and then go out. Any indicator lamp that remains on indicates a fault. Seek qualified technical assistance immediately.
- If the brake system warning light  comes on together with the  control lamp, the ABS regulation function may not work and the rear wheels may lock relatively quickly when braking. This can lead to loss of control of

the vehicle! If possible, slow down and drive slowly and carefully to the nearest specialist workshop to have the brake system inspected. During this journey, avoid heavy braking and any sudden manoeuvres.

- If the indicator lamp  does not go out, or comes on while driving, it means that the ABS function cannot work properly, is not available and will not work during braking. Go to a specialised workshop as soon as possible.

Assistant systems

General notes

Safety advice

⚠ WARNING

- Responsibility for driving rests with the driver at all times. The drive assist systems are not a replacement for driver attention. Focus all your attention on driving and be prepared to intervene at all times.
- Use the drive assist systems only when conditions allow. The driving style must always be suitable for the weather, visibility, road and traffic conditions.
- In order for drive assist systems to react correctly, sensors and cameras must operate without limitations. Please read the notes on sensors and cameras in this chapter.

i Note

- Keep in mind the specific rules of each country, especially when it comes to driving, formation of an emergency corridor, braking distance, speed, parking position, wheel position, etc. The driver is solely responsible for always complying with the specific regulations of each country.

- The area in front of and around the radar sensor should not be covered with adhesives, additional headlights or similar items, as this could have a negative impact on the operation of the assistants. If the vehicle is not properly repaired or structural modifications are made to it, the operation of the assistants may be affected.
- The repair and adjustment of sensors and cameras requires special knowledge and tools. It is recommended to visit a SEAT dealership for this purpose.

System limits

⚠ WARNING

- Drive assist systems can not overcome the laws of physics. Depending on the circumstances, a collision may not be avoidable.
- Warnings, notices and control lamps may not be displayed on time, or may be displayed incorrectly, e.g. if a vehicle approaches too quickly.
- Corrective interventions by drive assist systems (e.g. interventions in the steering or brakes) may be insufficient or may never occur, depending on the circumstances. As a driver, you must be prepared to act at all times.

i Note

- Due to the system's detection limits in the surroundings, the systems may not give warnings or intervene on time, or they might do so even if it is not desired. In addition, the auxiliary systems may incorrectly interpret a manoeuvre and, as a result, warn the driver in an unexpected manner.
- When the towing mode is selected, some assist systems may react with limitations, in an unusual way or may not be available. Keep in mind the instructions relating to the towing mode.

Button for the assistant systems




Fig. 90 On the turn light and main beam lever: key for driver assistance systems [depending on the version].



Fig. 91 Left side of the multifunction steering wheel: button for driver assistance systems (depending on the version).

Depending on the equipment, the button for the driver assistance systems is located on the turn signal and main beam lever or on the multifunction steering wheel. This button can be used to switch the driver assistance systems in the **Assistants** menu on and off.

- Press the  button to open the **Assistants** menu.
- Select the assistance system in question and turn it off or on. A mark indicates that assistant system is switched on.
- Next, confirm the selection by pressing the **OK** button on the multifunction steering wheel.

The assistant systems can also be switched on and off in the infotainment system, in the vehicle settings menu **>>> page 35**.

Drive assist sensors and cameras

Front radar



Fig. 92 On the front bumper: radar sensor.

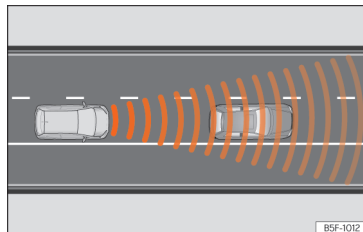


Fig. 93 Detection area.

A radar sensor may be fitted to the front bumper of the vehicle **>>> Fig. 92**.

The front radar detects any objects in its detection zone **>>> Fig. 93** and provides support for the following functions:

- Front Assist **>>> page 148**.
- Adaptive Cruise Control (ACC) **>>> page 143**.

The radar can have a range of up to 120 m (400 ft) depending on road and weather conditions.

WARNING

- The visibility of the radar sensor can be impaired by dirt or environmental influences such as rain, fog, snow, mud, dust, insects etc. In this case Front Assist and ACC functions may stop working. The instrument cluster display shows the following message: "Driver assist limited now. Front sensors without visibility." And Front Assist unavailable or ACC unavailable warning lights come on.
- Clean the sensor area on the bumper as indicated in **>>> page 306, Cleaning the exterior**. When the radar sensor starts correctly detecting again, the message disappears from the screen and the functions become available again.

NOTICE

- If the radar sensor is dirty or poorly adjusted, Front Assist system may give unnecessary warnings and apply the brakes inappropriately.
- The operation of the radar can be affected by strong reflections of the emitted signal. This may occur, for example, in an enclosed car park or due to the presence of metallic objects (e.g. guard rails or sheets used in road works).
- The sensor may not be adjusted correctly if it receives an impact. This may compromise the system's efficacy or disconnect it. If you have the feeling that the radar sensor is damaged or adjusted incorrectly, switch off Front Assist and ACC functions to avoid any damage. If this occurs have it adjusted.

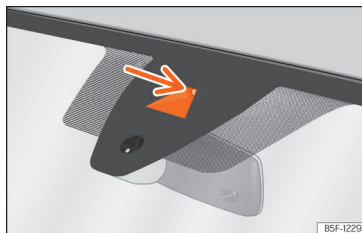
Front camera

Fig. 94 On the windscreen: field of vision of the Lane Assist system camera.

Depending on the equipment, the vehicle may be fitted with a front camera on the front windscreen. This camera detects lane boundaries (lines) to provide support for the following functions:

- Lane Assist >>> page 151.
- Travel Assist >>> page 153.

NOTICE

To avoid affecting the operation of the systems, take the following points into consideration:

- Clean the field of vision of the camera regularly and make sure it is free of snow and ice.
- Do not cover the field of vision of the camera.
- Check that the windscreen is not damaged in the area of the camera's field of vision.

Rear radar

Fig. 95 Rear view of the vehicle: radar sensor areas.

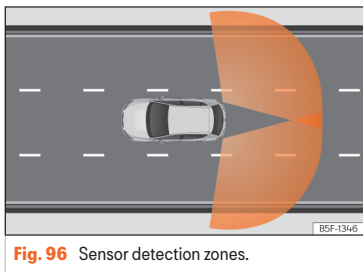


Fig. 96 Sensor detection zones.

The rear radar sensors are located on the left and right of the bumper and are not visible from the outside »» Fig. 95. The sensors monitor both the blind spot and traffic behind the vehicle »» Fig. 96.

They support the following functions:

- Side Assist »» page 156.
- Rear Cross Traffic Alert »» page 176.

Automatic deactivation of supported functions

The rear radar sensors deactivate automatically when, among other reasons, one of the sensors is detected to be permanently covered. This may be the case if, for example, there is a layer of snow or ice in front of one of the sensors.

The relevant text message will appear in the instrument panel display.

Indicator lamps

- Side Assist function not available
- Rear Cross Traffic Alert function not available.

NOTICE

- The radar sensors on the rear bumper may be damaged or shifted in the event of a collision, for example, when entering or exiting a parking space. This may result in the system disconnecting itself, or at least possibly having its functionality diminished.
- In order to ensure that the radar sensors work properly, keep the rear bumper free of snow and ice and do not cover it.
- The rear bumper should only be painted with paint authorised by SEAT. The lane departure warning's functions may be limited or work incorrectly if other paints are used.
- The visibility of radar sensors may be affected due to leaves, snow, strong haze or dirt, among others. Clean the area in front of the sensors.
- Never use auto lane changing or the rear cross traffic alert if the radar sensors are dirty.
- Radar operation may also be affected if objects such as bicycle racks or luggage racks interfere with the visibility of the radars.

Ultrasound sensors

The bumpers are fitted with ultrasound sensors to perform the following functions:

- Park Assist »» page 167.
- Park assist plus »» page 162.
- Rear park assist »» page 166.

NOTICE

- Damage to the radiator grille, bumper, wheel arch and vehicle underbody can modify the orientation of the sensors. This can affect the parking aid function. Have the function checked by a specialised workshop.
- A number plate or number plate holder with dimensions that exceed the space for the number plate, or a cured or deformed number plate can cause false detections or a loss of visibility for the sensors.

Note

- In order to guarantee good operation, keep the sensors clean, free of snow and ice, and do not cover them with stickers or other objects.
- If you use high-pressure or vapour equipment for cleaning, do not apply it directly, unless you do so very briefly, and always keep a distance of more than 10 cm away.

- Fitting certain accessories to the front of the vehicle, such as a plate holder with advertising, may interfere with the operation of the Park Assist.

Rear camera

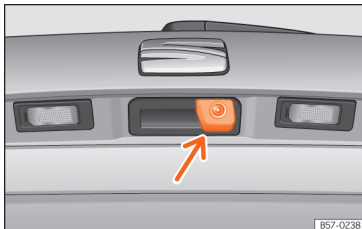


Fig. 97 On the rear lid handle: location of the rear assist camera.

A camera installed in the rear lid handle assists the driver with reverse parking or manoeuvring. This provides support to the following function:

- Rear View Camera >>> page 174.

WARNING

Fitting a number plate frame may interfere with the view shown on the screen, as it may reduce the camera's field of vision.

NOTICE

- In order to guarantee good system operation, keep the cameras clean, free of snow or ice, and do not cover them with stickers or other objects.
- Never use abrasive cleaning products to clean the camera lens.
- Do not use hot or warm water to remove ice or snow from the camera lens. Doing so could damage the camera.

Cruise control system

Introduction

The cruise control system (GRA) helps maintain a constant speed set by you.

Speed range

The cruise control system is available when driving in forward gear at a speed of over approx. 20 km/h (15 mph).

Temporarily switching off the cruise control

The saved speed can be exceeded at any time, e.g. for overtaking. The cruise control is suspended during acceleration and is then resumed with the saved speed.

Status display

When the cruise control system is switched on, the instrument cluster display shows the saved speed and the system status:

Lights up grey.
The cruise control system is switched on, but regulation is not active.

It lights up green.
The cruise control system is switched on and regulation is active.

If there is no speed saved, the instrument cluster display shows --- instead of speed.

Changing gears

As soon as the clutch pedal is depressed, regulation is suspended and resumes once the gear change has been made.

WARNING

If it is impossible to drive with sufficient braking distance and at a constant speed, using the cruise control system may cause accidents and serious injuries may occur.

- Do not use Travel Assist when visibility is bad, on steep roads, on windy roads or in slippery circumstances (such as snow, ice, rain or loose gravel), or on flooded roads.
- Only use the cruise control system on paved roads with a firm surface.

- Adapt your speed and safety distance to the vehicle in front of you at all times to suit the visibility, weather, road and traffic conditions.
- After use, always switch off the speed limiter to prevent the speed being regulated against your wishes.
- It is dangerous to use a set speed which is too high for the prevailing road, traffic or weather conditions.

Operating the cruise control



Fig. 98 On the multifunction steering wheel: cruise control operation buttons.

Connecting

- Press the button.

There is no speed saved and regulation is not yet operating.

Start regulation

- While driving, press the button **SET**.

The cruise control system saves and regulates the current speed.

Adjusting the speed

While the GRA is set, the stored speed can be adjusted:

- RES + 1 km/h (1 mph)
- SET - 1 km/h (1 mph)
- + + 10 km/h (5 mph)
- - 10 km/h (5 mph)

The cruise control system only operates the acceleration, **it does not brake** the vehicle.

Interrupting the adjustment

- Briefly press the button or press the brake pedal.

The speed is stored.

Reinstating the cruise control

- Press the **RES** button.

The cruise control system resumes the saved speed and regulates it.

Switching off

- Press and hold the button .

The cruise control system switches off and the saved speed is deleted.

Switching off the speed limiter

- Press the button.
- Select the speed limiter on the instrument cluster display.

The cruise control system is switched off.

Troubleshooting

Fault in the speed regulator

The control lamp switches on yellow.

Abnormal operation. Switch off the cruise control system and take the vehicle to a specialist workshop.

The adjustment is interrupted unexpectedly

- If the clutch pedal is pressed for a long time.
- The vehicle has exceeded the saved speed for a long time.
- No forward gear has been selected.
- A brake assistance system, e.g. TCS or ESC, has intervened.
- Front Assist has braked the vehicle.
- If the fault continues, disconnect the Emergency Assist and consult a specialised workshop.

Speed limiter

Introduction

The speed limiter helps the driver not to exceed a set speed.

Speed range

The speed limiter helps avoid exceeding a programmed speed, from 30 km/h (20 mph) approx. and faster.

By selecting the speed limiter

The speed limitation can be interrupted at any time by depressing the accelerator pedal fully, beyond the point of resistance. As soon as the saved speed is exceeded, the green indicator light flashes and an audible warning signal may sound. The speed is stored.

The limiter is reactivated automatically after returning to less than the set speed.

Status display

When the speed limiter is switched on, the instrument cluster display shows the saved speed and the system status:

Lights up green

The speed limiter is switched on but regulation is not active.

Lights up green

The speed limiter is switched on and active.

WARNING

After use, always switch off the speed limiter to prevent the speed being regulated against your wishes.

- The speed limiter does not relieve the driver of their responsibility to drive at the appropriate speed. Do not drive at high speed if not necessary.
- Using the speed limiter under adverse weather conditions is dangerous and can cause serious accidents, e.g. aquaplaning, snow, ice, leaves, etc. Only use the speed limiter when the status of the road and the weather conditions allow it.

Operating the speed limiter

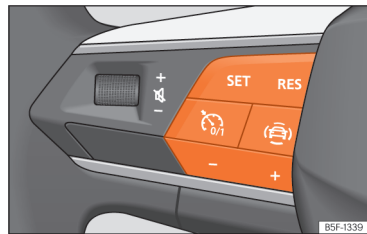


Fig. 99 On the multifunction steering wheel: buttons to control the speed limiter.

Connecting

- Press the  button.

Regulation has not yet taken place.

Start regulation

- While driving, press the button **SET**.

The current speed is saved as a limit speed.

Adjusting the speed

The programmed speed can be set:

RES + 1 km/h (1 mph)

SET - 1 km/h (1 mph)

+ + 10 km/h (5 mph)

- - 10 km/h (5 mph)

Interrupting the adjustment

- Press the  button.

The speed is stored.

Reinstating the cruise control

- Press the **RES** button.


The limiter will re-activate as soon as the vehicle is moving at a speed lower than the saved one.

Switching off

- Press and hold the button .

The speed limiter switches off and the speed is deleted.

Switch to another driver assistance system

- Press the  button.
- Observe the corresponding message on the instrument cluster display. The speed limiter is switched off.

Troubleshooting

LIM The speed limiter is not available

The control lamp lights up in yellow.

- Malfunctions: Switch off the speed limiter and go to a specialist workshop.

Regulation is interrupted unexpectedly

- You have switched off the Electronic Stabilization Control (ESC).
- The brakes have overheated. Wait for the brakes to cool down and check the operation again.
- If the fault continues, consult a specialised workshop.

For safety reasons, the speed limiter only switches off fully whenever the driver stops pressing the accelerator pedal or switches the system off manually.

Eco-efficient driving assistance

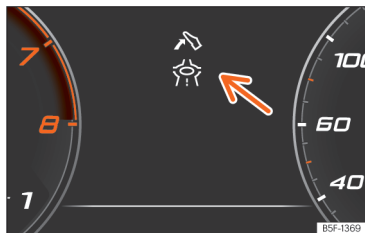



Fig. 100 Eco-efficient driving assistance indication [schematic representation].

Eco-efficient driving assistance helps you drive with care and with low energy consumption by following instructions superimposed in the digital cockpit, depending on the situation.

When you approach places such as a junction, a roundabout or a section of road with a speed limit, the symbol  is displayed along with an event on the digital instrument cluster

»» **Fig. 100.**

As soon as you follow the indication and take your foot off the accelerator, the vehicle adapts, based on the selected driving profile and distance to the incident, brake energy recuperation and speed.

Eco-efficient driving assistance uses the trip data from the infotainment system and the sensors of some assist systems. If no destination guidance is active, the most likely route is used.

Pressing the accelerator can cancel the intervention of the assistance at any time.

Eco-efficient driving assistance can be switched on and off in the infotainment system, in the assistance system settings »» **page 35.**

Eco-efficient driving assistance is temporarily switched off if:

- The gear selector is in the **S** position.
- The **Sport** driving program is used.
- Driving with adaptive cruise control (ACC) or cruise control (GRA).

When these conditions no longer exist, the assistance is reactivated if it is switched on in the assist system settings.

Eco-efficient driving assistance is available depending on the equipment, although not in all countries.

WARNING

The system is not a replacement for driver awareness.

- Adapt your speed and driving style at all times to suit visibility, weather, road and traffic conditions.
- Traffic signs on the road and traffic regulations have priority over eco-driving notes.

Note

- The appearance of the symbols may vary slightly depending on the equipment and model. System updates may modify or expand the symbols.
- When the system is switched on, eco-efficient driving assistance can also increase recuperation without any indication being displayed. This can occur in situations such as when the accelerator pedal is released when a vehicle is driving in front. In this case, energy recuperation is adapted match the speed of the vehicle in front without any indication being displayed.

ACC - Adaptive Cruise Control

Introduction

Adaptive Cruise Control (ACC) maintains a constant speed set by the driver. When approaching another vehicle in front, the ACC detects it and adapts the speed automatically, maintaining a distance set by the driver.

Does my vehicle have ACC?

Your vehicle has ACC if it has the ACC function buttons on the multifunction steering wheel >>> page 82, or if it has the configuration menu in the infotainment system.

Speed range

ACC regulates at speeds between 20 and 210 km/h (15 and 130 mph).


If the vehicle is fitted with an automatic gearbox, the ACC can bring the vehicle to a standstill if a vehicle in front of it stops.

If your vehicle is fitted with a manual gearbox, you must pay attention to speed and gear changes. The ACC is deactivated if the speed is too low (less than 30 km/h) of the engine RPM is too low or high.

Driving with ACC

You can override the ACC at any time. Braking interrupts the ACC. If you accelerate, regulation is interrupted during acceleration and then resumed.

Driver intervention prompt

-  ACC is subject to certain limitations inherent to the system. This means that the driver will have to control the speed and distance from other vehicles in certain situations. In this case, the instrument cluster display **will tell you to intervene** by applying the brake, and an audio warning will be played.

Radar sensors

The ACC uses the front radar technology. Read its maintenance instructions and information about its limitations >>> page 135.

WARNING

The ACC's technology cannot overcome the system's inherent limitations or change the laws of physics. If used negligently or involuntarily, it may cause serious accidents and injuries. The system is not a replacement for driver awareness.

- Always be prepared to brake or accelerate.
- If you press the accelerator pedal the ACC will stop working. Therefore, it will not brake or request any braking intervention.

- Adapt your speed and safe distance to the vehicle in front of you at all times to suit visibility, weather, road and traffic conditions.
- Do not use the ACC in poor visibility, or on roads that are steep, with lots of curves or slippery.
- Never use ACC when driving off-road or on unpaved roads.
- The system does not react in time to stationary obstacles (such as a traffic jam queue). React soon enough to avoid a hazardous situation.
- The system does not react to people, animals or vehicles that are crossing or approaching in the opposite direction.
- If you are driving with a spare wheel fitted, the ACC system could automatically switch off. Switch off the system when starting off.
- Brake immediately if the ACC does not slow down enough.
- Brake immediately when a driver intervention instruction is displayed on the instrument cluster screen.
- If the vehicle continues to move involuntarily after a driver intervention prompt, brake the vehicle.

Note

If the ACC does not work as described in this chapter, do not use it until it has been checked by a specialised workshop. Visiting a SEAT dealership is recommended.

ACC operation

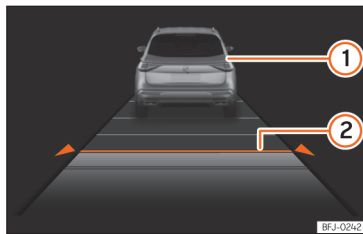


Fig. 101 On the instrument cluster screen: ACC active.



Fig. 102 On the multifunction steering wheel: buttons for operating the ACC.

>>> Fig. 101

- ① Vehicle detected in front. It will light up if the distance to the vehicle is adjusted.
- ② Selected distance level 2.

This information can be displayed on the central panel of the **Assistants** view, or in the left hand information profile >>> **page 16**. If these views are not selected, it will be automatically displayed in the lower central part of the instrument cluster in a simplified manner.

The set speed will be displayed next to the function status indicator.

Connecting

- Press the  button on the multifunction steering wheel >>> **Fig. 102**.

The ACC does not regulate anything yet (standby).

Start regulation

Activating the ACC system also automatically activates the ESC and traction control (TCS).

- To start regulation, press the **SET** button >>> **Fig. 102**.

The ACC sets the current speed, or the closest speed within the valid range, as the cruise speed.

Vehicles with automatic transmission: the gear lever must be in the **D**, **S** or **M**.

With manual transmission: the gear lever must be in any gear except first and reverse, and the speed must be higher than approximately 30 km/h (18 mph).

Depending on the driving situation, the following indicator lamps come on:

**Lights up green**

ACC connected, no vehicle detected in front.

**Lights up green**

ACC connected, vehicle detected in front.

When the ACC is in standby, the indicator lamps light up grey.

Program the speed



To program the speed, press the + or -

>>> **Fig. 102** buttons to the desired speed. The speed is adjusted at intervals of 10 km/h [5 mph].

While the ACC is active, you can press the **RES** button to increase the desired speed by 1 km/h [1 mph]. You can then press **SET** to decrease it by 1 km/h [1 mph].

Program the distance setting

The distance can be set to one of five levels, from very short to very long:

- Press the  button and then + or - button >>> **Fig. 102**.
- Alternatively, press  button as many times as necessary to set the desired distance.

Keep in mind each country's regulations on minimum braking distances.

Suspend regulation (standby)

- Briefly press  button >>> **Fig. 102** or press the brake pedal.


The ACC indicator lamp is grey; the speed and distance are saved.

If the ESC or TCS is switched off, the ACC is automatically interrupted.


Reinstating the cruise control

- Press the **RES** button. The ACC regulates to the last speed and distance setting.
- **OR:** Press **SET** button to regulate to the current speed.

Switching off

- Press and hold the button . The set speed is cleared.

Exceeding the speed regulated by the ACC

While driving with the ACC switched on, the driver can increase speed by pressing the accelerator pedal. ACC regulation is suspended until you release the accelerator pedal >>> .

Changing the driving profile

In vehicles with the SEAT Drive Profile, the selected driving profile can have an influence on the ACC's acceleration and braking behaviour >>> page 129.

*In vehicles without SEAT Drive Profile, the behaviour of the ACC can also be affected if any of the following drive profiles are selected in the infotainment system in **Drive assist**. ACC settings will be the same as those in the SEAT Drive Profile.*

**WARNING**

Before driving off, check that the road is clear. The radar sensor may not detect obstacles that could be on the road. This can lead to an accident and serious injury. Press the brake if necessary.

**NOTICE**

If you increase speed using the accelerator pedal, the ACC may not be able to safely adjust the speed of the distance due to the limitations of the system.

- **Be prepared to react if required by the situation.**

Special driving situations

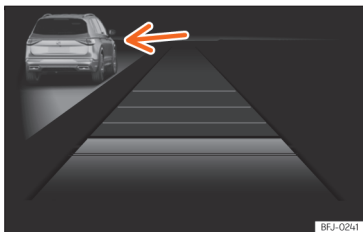


Fig. 103 On the instrument cluster screen: ACC active, vehicle detected on the left.

Be aware of the limitations and warnings described at the beginning of this chapter >>> page 143, *Introduction*.

Avoid undertaking on the right¹⁾

If a vehicle is detected in the left lane that is travelling at a speed slower than that set by the driver, it will brake the vehicle within the comfort limits of the system to avoid passing it on the right >>> **Fig. 103**.

You can cancel this regulation by changing the set speed or by pressing the accelerator pedal.

The function works at speeds over 80 km/h (50 mph). It may not be available in certain countries.

Overtaking

When the turn signal is switched on for overtaking, the ACC reduces the distance to the vehicle in front to help with the overtaking manoeuvre. The set cruising speed will not be exceeded.

The function works at speeds over 80 km/h (50 mph). It may not be available in certain countries.

Stop&Go function

Valid for vehicles with an automatic gearbox
The ACC can bring the vehicle to a standstill (0 km/h) if the vehicle in front stops.

The ACC remains active and the message **ACC ready to start** is displayed on the instrument cluster for a few seconds. During this time, the vehicle will move off again if the vehicle in front moves forwards.

If the vehicle in front does not move off, the vehicle can be kept at a standstill with the status **ACC ready to start** by pressing the brake.

The system can only keep the car stopped for a few seconds. After this, the **Brake** warning will be displayed and an audio warning will be played. Press the brake pedal. The vehicle may start moving forward if you do not do this **Accident hazard!**

The ACC is deactivated while stopped in the following cases:

- If the vehicle stops for several minutes.
- If a door is opened.

⚠ WARNING

If the message **ACC ready to start** is displayed on the instrument cluster display and the vehicle in front moves off, your vehicle will move off automatically. In this case, any obstacles in the road may not be detected. This may cause serious accidents and injuries.

- Always check the road before moving off, and apply the vehicle brakes yourself if necessary.

ACC system limitations

The limits of the ACC system mean that it is not appropriate in all situations.

SEAT does not recommend using the function in the following cases >>> ⚠:

- Heavy rain, snow or fog.
- When going through tunnels.
- On stretches of road with roadworks.
- On routes with curves, e.g. on mountain roads.
- On off-road routes.
- In covered car parks.

¹⁾ Or on the left, in countries that drive on the left hand side of the road.

- On roads with embedded metal objects such as train or tram tracks.
- On roads with loose gravel.

Pay special attention when using ACC in the following situations:

On curves

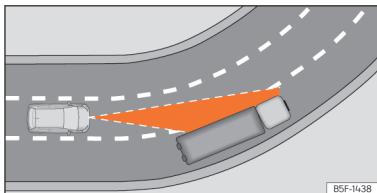


Fig. 104 Vehicle on a bend.

The ACC may not detect the vehicle in front on a curve, or may regulate the distance from vehicles in other lanes »» **Fig. 104**.

Vehicles outside the sensor zone

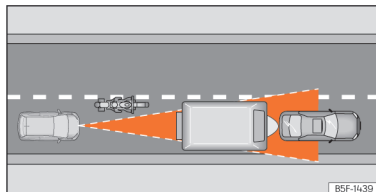


Fig. 105 Motorcyclist ahead out of range of the radar sensor.

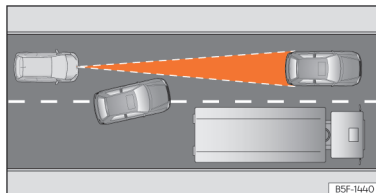


Fig. 106 Vehicle changing lanes.

In the following situations the ACC may not react, or may react slowly or inappropriately:

- Vehicles that are not aligned while driving or that are outside the sensor's detection area, such as motorcycles »» **Fig. 105**.
- Vehicles that move into your lane, a short distance from your vehicle »» **Fig. 106**.
- Vehicles with loads or accessories that protrude from the sides, rear or roof.

Objects that are not detected

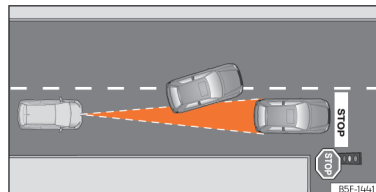


Fig. 107 A vehicle turning and another stationary.

The ACC function only detects and reacts to vehicles moving in the same direction. Therefore it does not detect:

- People
- Animals
- Vehicles travelling in the opposite direction or crossing the road.
- Other stationary obstacles

The ACC does not react to stationary vehicles. If, for example, a vehicle detected by the ACC turns or moves over and there is a stationary vehicle in front of it, the ACC will not react to the second vehicle »» **Fig. 107**.

⚠ WARNING

Using the ACC in the above situations can cause serious accidents and injuries, and you could break the law.

Troubleshooting

ACC not available

The indicator lamp lights up yellow:

- The radar sensor is dirty or adjusted incorrectly. Take into account the warnings described at the beginning of this chapter »» page 136
- There is a fault or a defect. Turn off the vehicle's ignition and turn it on again after a few minutes.
- If the problem persists, consult a specialised workshop.

The ACC does not work as expected

- Make sure that the conditions are met for the radar sensor to operate properly »» page 136.
- If the brakes overheat, regulation stops automatically. Wait for them to cool down and check the operation again.
- Unusual noises during automatic ACC braking are normal and do not indicate any anomalies.

The following conditions may lead the ACC not to react:

- The accelerator or brake is depressed.
- No gear is engaged or the vehicle is in gear R.
- The vehicle is reversing.

- ESC is operating.
- The driver is not wearing his/her seat belt.
- The RPM is too high or too low.
- A vehicle brake light is faulty.
- A trailer brake light is faulty.
- The parking brake is applied.
- Driving on an excessive slope.

Emergency brake assistance system (Front Assist)

Introduction

The objective of the system is to prevent head-on collisions against objects that may be in the vehicle's path or minimise the consequences of such impacts.

The function is designed to avoid collisions against:

- Parked vehicles.
- Vehicles, pedestrians and cyclists that are travelling in the same lane and direction.
- Pedestrians and cyclists who cross the vehicle's path.

Front Assist detects the aforementioned objects using a radar sensor at the front of the vehicle »» page 136.

Depending on several factors and how critical the situation is, the system operates in a staggered manner.

First by informing the driver, and if there is no or insufficient reaction, then by activating autonomous emergency braking as indicated by the conditions that will be discussed in the following points.

The system operation can be cancelled if the clutch pedal is pressed or the steering wheel is turned firmly.

WARNING

- **Front Assist is a driving assistance function that can never replace the driver's attention.**
- **Front Assist cannot change the laws of physics or replace the driver in terms of keeping control of the vehicle and reacting to a possible emergency situation.**
- **Following a Front Assist emergency warning, pay immediate attention to the situation and try to avoid the collision where appropriate.**
- **Always adapt your speed and distance away from the vehicle in front of you at all times to suit visibility, weather, road and traffic conditions.**
- **Front Assist alone cannot avoid accidents and serious injuries.**
- **Front Assist does not react to animals or vehicles crossing your path or approaching head-on down the same lane.**

- Front Assist does not react to pedestrians walking head-on in the same lane.
- If Front Assist does not work as described in this chapter (e.g. it repeatedly intervenes unnecessarily), switch it off. Have the system checked by a specialised workshop. SEAT recommends visiting a SEAT dealership.

Note

When Front Assist is on, the indications of other functions on the screen may be hidden.


Warning levels and brake assist



Fig. 108 On the instrument panel display: advance warning indications.


Front Assist is active from 5 km/h (3 mph). Depending on different conditions (vehicle speed, speed and type of object recognised, etc.), some of the stages described below are omitted to optimise the performance of the system.


Safety distance warning

If the system detects that you are driving too close to the vehicle in front, it will warn the driver with this indication on the instrument panel display .

The timing of the warning varies depending on driver behaviour, vehicle speed and relative speed between both.

Advance warning

If the system detects a possible collision with the vehicle in front, it alerts the driver by means of an audible warning and an indication on the instrument panel screen  **Fig. 108**.

The warning moment varies depending on the traffic situation and driver behaviour. At the same time, the vehicle will prepare for a possible emergency braking  **page 149**.

When Front Assist is connected, the indications of other functions on the screen may be hidden.

Critical warning

If the driver fails to react to the **advance warning**, the system may actively intervene in the brakes and generate a brief jolt to warn the driver of the imminent danger of a collision.

Automatic braking

If the driver also fails to react to the **critical warning**, the system may initiate independent emergency braking by progressively increasing the braking in accordance with the criticality of the situation.

Driver emergency braking assistance system

If the driver, after the critical warning, starts braking but the system detects that the brake is not being applied with sufficient force, the braking intensity will be increased.

WARNING

- The system cannot prevent a collision, although it can significantly minimise the consequences by reducing the speed and the force of the impact.
- When the Front Assist causes a braking, the brake pedal is “harder”.
- Automatic interventions by the Front Assist on the brakes may be interrupted by pressing the clutch, accelerator or moving the wheel.
- The Front Assist may brake the vehicle until it stops completely. However, the brake system does not halt the vehicle permanently. Use the foot brake!

System limitations



Fig. 109 On the instrument cluster screen: indication of the system's initial self-calibration.

Front Assist has certain limitations inherent to the system. Thus, in certain circumstances, some of the reactions may be inappropriate from the driver's standpoint. So pay attention in order to intervene if necessary.

The following conditions may cause the Front Assist not to react or to do so too late:

- In the first few instants of driving after switching on the ignition, due to the system's initial auto-calibration. During this period, a status icon »» Fig. 109 is displayed.

Unrecognised objects

- Loads and accessories of other vehicles that protrude over the sides, backwards or over the top.
- If there are metal objects, e.g. guard rails or sheets used in road works.
- Other vehicles crossing the vehicle's path.
- Misaligned vehicles.
- Narrow vehicles such as motorcycles.
- Vehicles approaching in the opposite direction.

Operating limitations

- If the radar sensor is disabled or faulty.
- If the radar sensor is dirty or covered.
- On taking tight bends or complex paths.
- When pressing the accelerator firmly or at full throttle.
- If the TCS has been disconnected or the ESC activated in **Sport mode**»» page 133.
- If the ESC is adjusting or is broken.
- If several brake lights of the vehicle or electrically connected trailer are damaged.
- If the vehicle is reversing.
- In case of snow or heavy rain.
- In complex driving situations (such as traffic islands, cut-through roundabouts, etc.), Front Assist may issue warnings and intervene in braking in an unnecessary manner.

For more details, see section »» page 135.

Manual activation and deactivation of the function

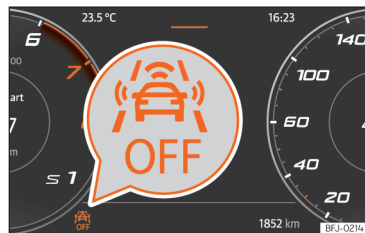



Fig. 110 On the screen of the instrument panel Front Assist switched off message.


Front Assist is active whenever the ignition is switched on.

When Front Assist is disabled, so too are the advance warning and the distance warning functions. SEAT recommends leaving the Front Assist activated except in the situations presented in »» page 151.

Switching Front Assist on and off


With the ignition switched on, Front Assist can be deactivated or activated as follows:

- In the infotainment system: press the function button  **Driver assistance > Front Assist** >>> page 35.
- **OR:** Select the corresponding menu option using the button for the assistants systems >>> page 135.

When Front Assist is disabled on the instrument cluster, the indication  will be displayed.

Each time the ignition is switched on, Front Assist will reappear as active.

Switching distance warning on and off

The distance warning can be activated or deactivated in the infotainment system using the function button  **Driver assistance > Front Assist** >>> page 35.

The system will store the setting for the next time the ignition is switched on.

SEAT recommends keeping the distance warning active.

Deactivating Front Assist temporarily in the following situations

In the following situations Front Assist should be deactivated due to the system's limitations:

- When the vehicle is to be towed.
- If the vehicle is on a test bed.
- When the radar sensor is damaged.
- If the radar sensor receives a violent impact.
- If it intervenes several times unnecessarily.

- If the radar sensor is temporarily covered by an accessory.
- When the vehicle is going to be loaded onto transportation.

Lane Assist system

Introduction

The Lane Assist System helps the driver stay in his/her lane within the physical limits of the system. This function is not suitable and is not designed to keep the vehicle automatically in the lane.

Using the camera located in the windscreen, the Lane Assist system detects the lane boundaries dividing the lanes in which the vehicle is travelling. If the vehicle gets too close to the detected lane limits, the system alerts the driver through a corrective motion of the steering wheel. The driver can cancel the steering corrective action at any time.

No warning will be given when the turn signals are activated, given that the Lane Assist system understands that a lane change is required.

System limits

Use the Lane Assist system only on large, well-maintained motorways and highways.

The system is not available under the following conditions:

- The driving speed allowed is below approx. 60 km/h (35 mph).
- The system has not detected any lane lines.
- On tight bends.
- Temporarily in very sporty driving situations.
- If the driver firmly rectifies a system intervention.
- If a lane marking is crossed despite system intervention.
- If the driver does not react to a request to intervene.

WARNING

The intelligent technology in the Lane Assist system cannot change the limits imposed by the laws of physics and by the very nature of the system. Careless or uncontrolled use of the Lane Assist system may cause accidents and injury. The system is not a replacement for driver awareness or manoeuvres when driving.

- **Always adapt your speed and the distance to the vehicles ahead in line with visibility, weather conditions, the condition of the road and the traffic situation.**
- **Always keep your hands on the steering wheel so it can be turned at any time. The responsibility of staying in the lane is always the driver's.**

- The Lane Assist system does not detect all road markings. The road surfaces, road structures or objects in poor condition can be incorrectly detected as road markings under certain circumstances by the Lane Assist system. Immediately counter any unwanted intervention of the system.

- Please observe the indications on the instrument panel and act as is necessary if the traffic situation permits.

- In the following situations there may be undesired interventions of the system or it may be that the system does not intervene at all. In these situations, special attention is required from the driver and, where appropriate, the temporary deactivation of the lane assist warning system:

- In very sporty driving situations.
- In adverse weather conditions and roads in poor condition.
- When passing through areas undergoing works.
- Before gradient changes of grade and river beds.

- Always observe the vehicle surroundings carefully and drive proactively.

- When the area of vision of the camera becomes dirty, covered or is damaged, the Lane Assist system function can be affected.

Driving with the Lane Assist System

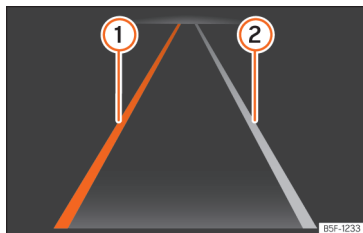


Fig. 111 On the instrument cluster display: indications of the lane assist system.

- ① Yellow line: The system intervenes assisting on the represented side.
- ② White line: Lane line detected. The system is ready to intervene on the displayed side. When the line is grey, the lane line is detected but the system is in a passive state or not available for intervention.

Control lamps



Lights up grey

Lane departure warning system switched to passive and not available for guidance.



Lights up green

Lane Assist system active and available.



Lights up yellow

The Lane Assist system is intervening by adjusting the steering.

Switching the lane assist system on or off

In some countries, the Lane Assist system is always activated when the ignition is switched on. The connection status is shown in the **Driver assistance** menu of the Infotainment system or the driver assistance systems menu after pressing the corresponding button. These menus can be used to activate and deactivate the system.

The Lane Assist system is designed to actively intervene as of approximately 65 km/h (40 mph) and if it has detected the lane boundaries (system status: active).

When a turn signal is activated, the system temporarily switches to a passive state in the indicated direction to allow for a manual lane change, and is available for operation in the opposite direction.

An energetic rotation or rectification of the steering wheel by the driver causes the system to temporarily switch to a passive state.



When Lane Assist is switched off, the yellow disconnection warning lamp lights up in the instrument cluster (depending on the country).

Note

If a system fault persists, Lane Assist may switch off automatically.

Driver intervention prompt

If the steering is not corrected manually, the system prompts the driver an indication on the instrument cluster display and audible warnings.

If no reaction is obtained from the driver, the system switches to a passive state.

Regardless of the steering manoeuvres, an indication on the instrument cluster display and audible warnings also prompt the driver to drive in the middle of the lane if the steering correction lasts longer than reasonable.

Steering wheel vibration

The following situations may result in a steering wheel vibration:

- The lane ceases to be recognised during a sudden intervention in the steering by the system.

It is also possible to select steering wheel vibration in the **Assistants** menu of the infotainment system. In this case, when a vehicle with Lane Assist switched on crosses over a detected lane marking, the steering wheel will vibrate.

Troubleshooting

The lane departure warning assistant is not available

The control lamp lights up in yellow. A relevant warning is also displayed on the instrument cluster display.

- The field of vision of the camera is dirty. Clean the windscreen **>>> page 305**.
- The camera has decreased visibility due to accessories or adhesives.
- There is a fault or a defect. Switch the engine off and on again.

The system behaves differently than expected

- The camera has been altered or damaged, e.g. because of damage caused to the windscreen. Check for visible damage.
- Do not mount objects on the steering wheel.

If the problem persists, consult a specialised workshop.

Note

After switching on the ignition, it may take a few seconds before a fault is detected in the system.

Note

If Lane Assist is unavailable, Travel Assist will be unavailable as well.


Travel Assist

Introduction

Travel Assist combines adaptive cruise control (ACC) and the adaptive lane guidance function. Within the limitations of the system, the vehicle can maintain a distance from the vehicle in front that is preselected by the driver and remain in the preferred position within the lane.

Travel Assist uses the same sensors as Adaptive Cruise Control (ACC) and Lane Assist. Therefore, carefully read the information about the ACC **>>> page 143** and the Lane Assist **>>> page 151** and take into account the limitations of the systems and the indications given in the information.

How to know if the vehicle is fitted with Travel Assist

The vehicle is fitted with Travel Assist if the multifunction steering wheel has the  button.

Speed range

Depending on the type of gear, Travel Assist regulates from 0 km/h (0 mph). The speed can be set from 30 km/h (20 mph).

Driving with Travel Assist

Travel Assist automatically controls the accelerator pedal, the brakes and the steering. In addition, Travel Assist may, within its limitations, decelerate the vehicle until it stops behind another that stops and automatically starts again.

You can override assisted adjustment at all times.

Status display

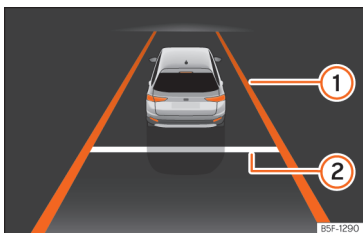





Fig. 112 On the instrument cluster display: display of active regulation (schematic representation).

- ① The colour of the lane markings indicates the status of the adaptive lane guidance function.
 - **Yellow:** adaptive lane guidance function active.
 - **Grey:** passive adaptive lane guidance function.

② Distance set.

Depending on the equipment, additional details, e. g. dashed road markings and vehicles in front, can also be shown on the instrument cluster display.

Control lamps indicate the status of the system on the instrument panel display:

-  Indicator lamp green: Travel Assist active, adaptive cruise control and adaptive lane guidance function are active.
-  Partially green lamp: Travel Assist active, adaptive cruise control active and adaptive lane guidance function passive.
-  Grey lamp: Travel Assist deactivated, not regulating.

⚠ WARNING

The Travel Assist smart technology cannot overcome the limits imposed by the laws of physics and it only works within the limits of the system. If Travel assist is used negligently or involuntarily, it may cause serious accidents and injuries. The system is not a replacement for driver awareness.

- Bear in mind the system limitations and the indications regarding the control of the Adaptive Cruise Control (ACC) and Lane Assist.

- Adapt your speed and safety distance to the vehicle in front of you at all times to suit visibility, weather, road and traffic conditions.
- Do not use Travel Assist when visibility is bad, on steep roads, on windy roads or in slippery circumstances (e. g., snow, ice, rain or loose gravel), or on flooded roads.
- Do not use Travel Assist offroad or on roads where the surface is not firm. Travel Assist has been designed for use on paved roads only.
- Travel Assist does not react to people or animal or vehicles crossing your path or which approach you head-on in the same lane.
- Brake immediately if Travel Assist does not slow down enough.
- Brake immediately when instructed to do so on the instrument cluster display, or if Travel Assist does not reduce speed sufficiently.
- Brake when the vehicle continues to move forward without it being desired after an indication to brake.
- If possible, do not wear gloves while driving. The system could interpret this as no driving activity.
- If driver intervention is requested on the instrument panel display, immediately resume control of the vehicle.


- Keep your hands on the steering wheel at all times, to ensure you have control over the steering at all times. The driver is always responsible for keeping the vehicle in its own lane.
- Always be prepared to adjust the speed yourself.

Operating Travel Assist



Fig. 113 Left side of the multifunction steering wheel

Switch on and start regulation

1. While driving with ACC activated, press  on the multifunction steering wheel.
The vehicle switches from ACC to Travel Assist.

Depending on the driving situation, the vehicle switches to the following system statuses in Travel Assist:

- If the ACC was already regulating, Travel Assist maintains the current speed and the preset distance to the vehicle in front.

When lane markings are detected, the vehicle is also kept in the lane by steering movements.


- If ACC was not already regulating, Travel Assist remains selected but in a passive status [not regulating].

Press the **SET** button.

Travel Assist switches to the active system status, depending on the driving situation.

The indicator lamp for the driving situation lights up on the instrument cluster display. A message is also displayed.

Interrupting regulation

1. Briefly press the button .

OR: press the brake pedal.

The set distance remains saved.

Switch to ACC

1. Press the  button on the multi-function steering wheel.

The vehicle switches from Travel Assist to the ACC system status corresponding to the driving situation.

Making other adjustments

All other aspects of Travel Assist are controlled like the ACC.

Troubleshooting

Travel Assist is not available or does not work as expected

The control lamp lights up in yellow. A relevant warning is also displayed on the instrument cluster display.

- There is a fault in the sensors. Check the causes and solutions described in the information about the ACC **>>> page 148** or the Lane Assist **>>> page 153**.
- There is a fault or a defect. Switch the engine off and on again.
- The system limits are exceeded.
- If the problem persists, consult a specialised workshop. SEAT recommends visiting a SEAT dealership.

Grip the steering wheel

The warning lamp lights up white and a message is then shown on the instrument cluster display.

- You released the steering wheel for a few seconds. Take hold of the steering wheel and take control of the vehicle.

Grip the steering wheel

The warning lamp lights up red and a message is shown on the instrument cluster display. Depending on the situation, an audio warning sounds or the steering wheel vibrates.

- You have let go of the steering wheel for a long time, or the system limits have been reached. Immediately take hold of the steering wheel and take control of the vehicle.

Travel Assist disconnects automatically

- There is a fault or a defect. Switch the engine off and on again.
- If the problem persists, consult a specialised workshop. SEAT recommends visiting a SEAT dealership.

Regulation is interrupted unexpectedly

- You have turned on the turn signal.

Lane departure warning (Side Assist)

Introduction

The lane departure warning uses radar sensors to monitor the areas behind the vehicle >>> **page 6**. The system does this by measuring the vehicle's distance from other vehicles and its speed differential. The lane departure warning will not work at speeds of less than approx. 15 km/h (9 mph).

Lane width is not detected individually, but is rather pre-configured in the system. Thus if you are driving in wide lanes or in between two lanes, the indications may be incorrect. Further-

more, the system can detect vehicles driving in the lane next to you (if there are any), and can also detect stationary objects such as dividers, and thus give an incorrect indication.

Trailer mode

Side assist is automatically deactivated and cannot be switched on if the factory-fitted tow-bar is electrically connected to a trailer or similar device.

As soon as the driver starts to drive with a trailer connected electrically to the vehicle, a message is displayed on the instrument cluster display indicating that side assist is switched off. Once the vehicle trailer has been disengaged, side assist will return to the initial state prior to the moment the trailer was electrically connected.

If the tow-bar is not factory fitted, side assist should be switched off manually when driving with a trailer.

Physical limitations inherent to the system

In some situations the lane departure warning may not interpret the traffic situation correctly. I.e. in the following situations:

- on tight bends;
- in the case of lanes with different widths;
- in areas with significant gradient changes;

- in adverse weather conditions;
- in the case of special constructions to the side of the vehicle, e.g., high or irregular dividers.

WARNING

The smart technology incorporated into Side Assist cannot overcome the limits imposed by the laws of physics; it only works within the limits of the system. Accidents and severe injury may occur if Side Assist is used negligently or involuntarily. The system is not a replacement for driver awareness.

- Adapt your speed and safe distance to the vehicle in front of you at all times to suit visibility, weather, road and traffic conditions.
- Keep your hands on the wheel at all times to be ready to intervene in the steering at any time.
- Pay attention to the control lamps that may come on in the external interior mirrors and on the instrument cluster, and follow any instructions they may give.
- The lane departure warning could react to any special constructions that might be present to the sides of the vehicle, e.g. high or irregular dividers. This may cause erroneous warnings.
- Never use the lane departure warning on unpaved roads. The lane departure warning has been designed for use on paved roads.
- Always pay attention to the vehicle's surroundings.

- The control lamps of the lane departure warning may have limited functionality due to solar radiation.

Note

If Side Assist does not work as described in this chapter, stop using it and contact a specialised workshop.

Driving with Side Assist

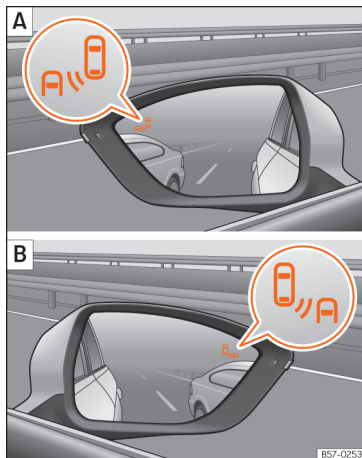


Fig. 114 Control lamp of the lane departure warning.

Connecting and disconnecting

Side Assist can be switched on and off by accessing the **Assistants** menu of the infotainment system or through the instrument cluster display using the controls on the steering wheel. If the vehicle is equipped with a multi-function camera, it can also be accessed by means of the assistants systems key located on the main beam headlight lever.

When the lane departure warning is ready to operate, the indications in the control lamps will turn on briefly as confirmation.

When the vehicle is restarted, the last adjustment in the system will remain active.

Indication on the exterior mirror

The control lamp provides an indication on the corresponding side regarding the traffic situation behind the vehicle, if it is deemed to be critical. The control lamp on the left-hand side indicates the traffic situation to the rear left of the vehicle, and the control lamp on the right-hand side indicates the traffic situation to the rear right of the vehicle.

In the case of retrofitted tinted windows or windows with tinted film, the indications of the external mirrors may not be seen clearly.

Keep the external mirrors clean and free of snow and ice, and do not cover them with adhesives or other similar materials.

It lights up

It turns on once briefly: the lane departure warning is activated and ready to operate, i.e. when activating the system.

It lights up continuously: the lane departure warning has detected a vehicle in the blind spot.

Flashes

A vehicle has been detected in the adjacent lane and the turn signal has been engaged in the direction of the detected vehicle.

For vehicles that are also equipped with Lane Assist »» page 151, a warning to switch lanes will also appear even though the turn signal has not been engaged (Lane Assist "Plus").

The control lamps light up when the ignition is switched on and should turn off after approximately 2 seconds. This is the time taken for the function check.

If there are no indications from the control lamp of the lane departure warning, this means that the lane departure warning has not detected any other vehicles at the rear area.

When the exterior lighting is low, the intensity with which the control lamps come on is dimmed. The user can modify the intensity of the control lamps with up to 5 levels in the infotainment system menu.

Lane assist Plus.

The Lane Assist Plus function can be used by activating the **Lane Assist** »» page 151 and **Side Assist** functions. In this case its functions are expanded as described below.

If the driver initiates a lane change manoeuvre in a potential critical situation:

- The lamp flashes in the corresponding rear-view mirror even though the turn signal has not been activated.
- The steering wheel vibrates to warn the driver of the risk of collision.
- torque is applied to correct the steering and return the vehicle to its lane.

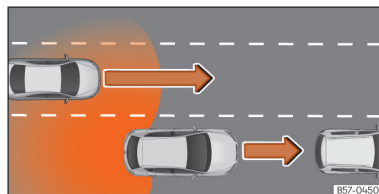
Driving situations

Fig. 115 Overtaking with traffic behind the vehicle.

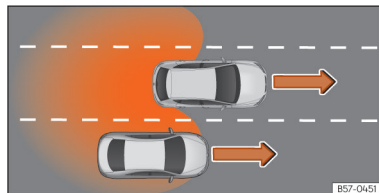


Fig. 116 Overtaking in the central lane and then joining the right lane.

In the following situations, an indication will be displayed by the control lamp »» **Fig. 114** (arrow):

- When being overtaken by another vehicle »» **Fig. 115**.
- When overtaking another vehicle »» **Fig. 116** with a speed difference of approx. 10 km/h (6 mph). If the vehicle is passing at a considerably higher speed, no indication will be displayed.

The faster the vehicle approaches, the sooner an indication will be displayed in the control lamp, because the lane departure warning takes into account the speed differential with other vehicles. Thus even though the distance from the other vehicle is identical, the indication will appear sooner in some cases and later in others.

Parking and manoeuvring

Park the vehicle

Parking

When parking your vehicle, all legal requirements should be observed.

1. Apply the parking brake.
2. *Automatic transmission*: move the selector lever to position **P**.
3. Stop the engine and turn off the ignition. Turn the steering wheel slightly to engage the steering lock.
4. *Manual gearbox*: engage first gear on flat ground and slopes, or even reverse gear on hills, and release the clutch pedal.
5. On slopes, turn the steering wheel so that if the parked vehicle were to start moving, it would steer toward the kerb.
6. Exit the vehicle »» » ⚠. Watch out for other road users!
7. Take all vehicle keys with you and lock it.

To avoid damage or hazardous situations, always park the vehicle on a suitable parking surface »» » ⓪.

Rear seat warning

The function depends on the vehicle's equipment.

When the ignition is switched off, a text message in the infotainment system reminds you not to leave any passengers in the rear seats »» » ⚠.

If a rear door was used before the trip, a text message is also displayed on the instrument cluster and an audible warning may sound. This warning can be activated/deactivated in the infotainment system menu **Settings > Screen settings > Rear seat warning**.

⚠ WARNING

If the vehicle is parked incorrectly, it could roll away, even on gentle slopes. This can cause accidents and serious injuries.

- When parking, always carry out the operations in the stipulated order.
- Before leaving the vehicle, make sure that the parking brake is applied.

⚠ WARNING

If children, people who may need assistance or animals are left unattended in the vehicle, accidents and serious injuries can occur.

- Never leave children, people who may need assistance or animals unattended in the vehicle. They could operate the gear selector or tamper with the parking brake. The vehicle could be set in motion.
- Never leave children, people who may need assistance, or animals in the vehicle. Depending on the season, very high or low temperatures can be reached inside a closed vehicle.
- Always take all vehicle keys with you when leaving the vehicle.

ⓘ NOTICE

The presence of irregularities on the ground, sand or mud can cause damage to the vehicle and mean that it cannot be parked properly.

- Always park the vehicle on firm and flat ground.

NOTICE

Components on the underside of the vehicle, such as bumpers, spoilers and running gear components, can be damaged when running over objects protruding from the ground.

- Drive carefully when entering buildings, on ramps, driving over kerbs or fixed markings, and on descents.

NOTICE

Avoid parking the vehicle where the hot exhaust system could ignite inflammable materials, such as dry grass, low bushes, spilt fuel or flammable materials.

NOTICE

In vehicles with automatic transmission, the key can only be removed from the ignition when the lever is in position P.

Parking brake

Using the parking brake

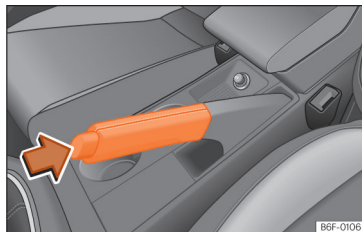


Fig. 117 Parking brake between the front seats.

The parking brake prevents the vehicle from accidentally moving. Leave the parking brake on when leaving or parking the vehicle.

- (P)** When the parking brake is applied, the red indicator lamp on the instrument cluster lights up.

Applying the parking brake

- Pull the parking brake lever up >>> **Fig. 117**.

Release the parking brake

- Pull the lever slightly up, press the unlock button in the direction of the arrow >>> **Fig. 117** and lower the lever completely >>> **△**.

Always pull the handbrake all the way up, to avoid driving off while the brake is on >>> **△**.

WARNING

- Never use the parking brake to stop a moving vehicle. This greatly increases the braking distance as the brakes are only applied to the rear wheels. Accident hazard!
- Failure to fully lower the parking brake lever can affect the operation of the system, and can also cause heating and wear of the rear brakes.

NOTICE

Remember to always apply the parking brake when leaving the vehicle. In addition, engage first or rear gear in the gradient function, or set the selection lever to P.

General information on parking systems

Automatic brake operation

The automatic braking feature of a parking system is used to reduce the danger of collision when an obstacle is detected during a parking manoeuvre.

Braking functions

Depending on the equipment, the following systems are available:

- Park assist plus manoeuvre braking function »» page 162.

- Rear cross traffic alert emergency brake function »» page 176.

- Assisted parking assistant emergency brake function »» page 167.

Infotainment system lamps



White lamp: system activated, the system brakes when it detects an obstacle in the path.



Coloured lamp: system deactivated, the system does not brake when it detects an obstacle although the sensors still detect it.

Requirements

- The vehicle is moving between approx. 3 km/h and 8 km/h when manoeuvring
- A parking system is switched on.

The brakes are not automatically operated when park assist is switched on automatically while moving forward.

What happens in the event of automatic braking?


If there is an obstacle, the system brakes the vehicle to a standstill and keeps it stationary for approx. 2 seconds. **Press the brake!**

Activate

- Automatic braking is activated when the driver switches a parking system on.

Deactivating

- The automatic brake operation function deactivates when a park assist system is switched off.

- **OR:** to temporarily deactivate the manoeuvre braking function, press the  function button on the park assist screen and change the setting.

WARNING

Never allow the automatic braking operations of park assist systems to lead you to take any risk that compromises safety. In certain situations, the automatic braking intervention may only work in a limited way or not work at all. Collisions with obstacles can injure people and damage the vehicle. The system is not a replacement for driver awareness.

- **Pay attention and do not rely solely on park assist systems.**
- **Always be prepared to brake and control the steering yourself.**
- **Do not take any risks that compromise safety.**
- **Act in accordance with the warnings and driving recommendations of the parking systems.**

Note

- **Switch off the parking system if the automatic brakes operate excessively, e.g. when driving off-road.**
- **After the park assist's manoeuvre braking function has braked the vehicle, driving in the same direction for 5 metres is deactivated, and becomes active again after changing gear or changing the position of the gear selector.**

Troubleshooting

The parking system behaves differently than expected

There can be several causes:

- The system requirements are not met.
- The sensors or the camera are dirty or have ice on them »» page 306.
- The camera lens is not clean and the camera image is not clear »» page 306.
- Some noise sources, such as a jackhammer or a cobblestone surface can interfere with the ultrasound signal.
- The vehicle has some type of damage in the sensor or camera area, e.g. due to a parking impact.
- The sensor detection zone or field of view of the camera are blocked by an accessory, e.g. a bike rack.

- Changes have been made to the paintwork or structural modifications in the sensor or camera area, e.g. at the front of the vehicle or to the running gear.

Also take into account the messages displayed on the infotainment system display.

Sensor or camera without visibility, or the parking system has been switched off

If a sensor fails, that sensor zone is permanently switched off. The affected sensor zone may be displayed on the infotainment system with a ! symbol and a greyed-out graphic segment. If necessary, the parking system switches off the affected zone.

If the park assist is not working properly, a continuous audible signal sounds for a few seconds when it is switched on. If applicable, a message to this effect is displayed on the instrument cluster display

- Check if one of the causes indicated above has occurred.
- Once the source of the problem has been eliminated, the system may be reconnected.
- If the problem persists, consult a specialised workshop.

Park Distance Control Plus (Park Pilot)

Description

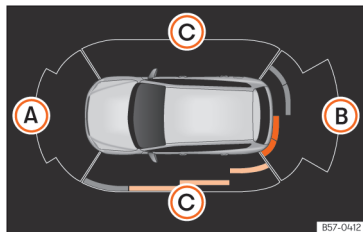


Fig. 118 Parking aid view on the Infotainment system display.

Parking aid plus assists the driver by giving visual and audio warnings about obstacles detected in front of and behind the vehicle.

The bumpers are fitted with sensors. When an obstacle is detected, it is indicated by audible signals and in the Infotainment system >>> **Fig. 118.**

When moving close to an obstacle, it is possible to know if the obstacle is in front of the vehicle or behind it according to the sound frequency.

The approximate measurement range of the sensors is:

- A** 1.20 m

- B** 1.60 m
- C** 0.90 m

As you approach the obstacle, the frequency of the audible signals will increase. The signal will sound continuously at around 0.30 m: Stop the vehicle!

If the separation is maintained, the warning volume is reduced after about 4 seconds.

In order to view the entire periphery of the vehicle, the vehicle must be moved a few metres forwards or backwards. Therefore, the missing areas are screened and obstacles at the sides of the vehicle **C** are displayed >>> **Fig. 118.**

Special features of ParkPilot with Area View


In the following situations the screened area on the side of the vehicle is automatically hidden:

- When a vehicle door is opened.
- When the TCS is switched off.
- When there is TCS or ESC regulation.
- If the vehicle remains stationary for more than approximately 3 minutes.

Error messages

If an error or fault message is displayed on the instrument cluster in Park Assist, there is a fault.

If the fault doesn't disappear before disconnecting the ignition, it will not be indicated next time the parking aid is connected.

If a rear sensor is faulty, only the obstacles in the front area are detected. If a front sensor is faulty, only the obstacles in the rear area are displayed. The symbol  is displayed.

We recommend taking the vehicle to a specialised workshop to have the fault repaired.

Trailer mode

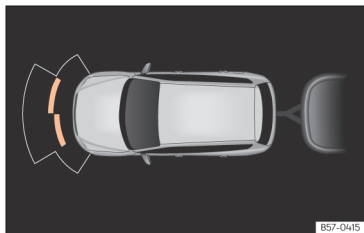




Fig. 119 Parking assist display on the screen with trailer attached.

On vehicles with a factory-fitted trailer hitch, when the trailer is connected, the rear sensors will not activate when reverse gear is engaged or button  is pressed. Therefore, any objects behind or to the side of the vehicle will not be indicated on the screen and no audio signals will sound.

The screen will only display objects detected at the front, and the vehicle's trajectory will be hidden.

Parking assist settings

The audio indications and signals are set in the infotainment system  page 35:

- **Automatic activation:** On/off
- **Front volume:** Volume in the front and rear area.
- **Rear volume:** Volume in the rear area.
- **Reduce volume:** When the parking aid is switched on, the volume of the audio source will be reduced, depending on the selected option.
- **Front sound settings/treble:** Sound tone in the front area.
- **Rear sound settings/treble:** Sound tone in the rear area.

WARNING

- Always pay attention, by looking directly, to traffic and the area around the vehicle. Assistance systems are not a replacement for driver awareness. Responsibility always lies with the driver.
- The sensors have blind spots in which obstacles and people are not detected. Pay special attention to children and animals.
- Always keep visual control of the surroundings: use the mirrors for additional help.

NOTICE

Park assist plus functions can be affected by various factors which may cause damage:

- Under certain circumstances, the system does not detect or display certain objects:
 - Chains, trailer draw bars, bars, fences, posts and thin trees.
 - Objects that are located above the sensors, such as protrusions in a wall.
 - Objects with certain surfaces or structures, such as wire mesh fences or powder snow.
- Certain surfaces of objects and garments do not reflect the ultrasound sensors' signals. The system cannot detect these objects or people wearing such clothes correctly.
- Sensor signals may be affected by external sound sources. This may prevent them from detecting people or objects.
 - If the system warns you of the proximity of a low obstacle, please note that after being detected by the system, the obstacle in question may disappear from the measurement sensors as the vehicle moves closer, and the system will no longer warn of its presence. In certain circumstances, objects such as high kerbs that could damage the underside of the vehicle are not detected.
 - If the parking distance warning system is ignored, the vehicle could suffer considerable damage.

- Damage to the radiator grille, bumper, wheel arch and vehicle underbody can modify the orientation of the sensors. This can affect the parking aid function.

Have the function checked by a specialised workshop.

- A number plate or number plate holder with dimensions that exceed the space for the number plate, or a cured or deformed number plate can cause false detections or loss of visibility for the sensors.

Note

- The display on the Infotainment system screen shows a slight time delay.
- In certain situations, the system can give a warning even though there is no obstacle in the detected area:
 - Rough or cobbled surfaces or surfaces with long grass.
 - External ultrasound sources, such as other vehicles equipped with ultrasound systems.
 - Heavy rain or snow, hail or dense exhaust gases.
 - If the number plate is not properly secured to the surface of the bumper.
 - Gradient changes.

- In order to guarantee good operation, keep the sensors clean, free of snow and ice, and do not cover them with stickers or other objects.

- If you use high-pressure or vapour equipment for cleaning, do not apply it directly, unless you do so very briefly, and always keep a distance of more than 10 cm away.

- Fitting certain accessories to the front of the vehicle, such as a plate holder with advertising, may interfere with the operation of the Park Assist.

- We recommend that you practice parking in an area without traffic.

- The volume and tone of the signals and indications can be changed.

- Please observe information on towing a trailer.

Note

In vehicles without an infotainment system, these parameters can be modified in a SEAT Official Service or in a specialised workshop.

Operating Park Assist Plus



Fig. 120 Centre console: parking aid button (depending on the version).

Switching on and off manually

- Press the **P₊** button once.


Automatic activation

- Select reverse gear.
- **OR:** if you drive forward at a speed of less than 15 km/h (9 mph) and an obstacle is encountered, it is detected when it is approx. less than 95 cm. away. If the automatic connection is activated, a reduced view is shown.
- **OR:** if the vehicle moves backwards.

When the **Plus Parking Aid** connects automatically, a diagram of the vehicle and the segments will appear on screen.

It only operates every time the speed drops below 15 km/h (9 mph) for the first time.

Automatic activation of park assist can be switched on and off in the infotainment system:

- Switch the ignition on.
- In the infotainment system, select  > **Settings** > **Parking and manoeuvring**.
- Check the **Automatic activation** box.
- **OR**, in the parking assistance function, select **Settings** > **Automatic activation**.

If activated automatically, an audible sound warning will only be given when obstacles in front are at a distance of less than 50 cm. approx.


If it is switched off using the **P₁₁** button, one of the following actions must be taken for it to re-activate automatically:

- Switch off the ignition and switch it on again.
- **EITHER**: drive forward at over approx. 15 km/h (9 mph).
- **OR**: move the lever into position **P** and back again.
- **OR**: switch the automatic activation on and off in the Infotainment system.

Automatic disconnection

- Drive forward at 15 km/h (9 mph) or faster.
- **OR**: move the selector lever to position **P**.

Temporary sound suppression

- Press the  function button on the infotainment screen.

Change from reduced view to full view

- Select reverse gear.
- Press the car icon on the reduced view

Switch to the reverse assist image (Rear View Camera "RVC")

- Select reverse gear.
- **OR** press the **RVC** function button ¹⁾.

A short confirmation signal will be heard and the button symbol will light up when the system is switched on.

NOTICE

Park assist plus only connects automatically when driving very slowly. If driving style is not adapted to the circumstances, an accident and serious injury or damage may be caused.

Visual indication segments

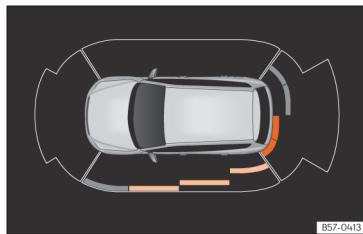


Fig. 121 Parking aid view on the Infotainment system display.


The optical indication of the segments works as follows:

- **White segments**: the obstacle is more than approx. 30 cm away from the path or in the direction opposite to travel. They are also displayed when the parking brake is applied.
- **Yellow segments**: the obstacles lie on the vehicle's path and are at a distance of less than approx. 30 cm away.
- **Red segments**: obstacles are less than approx. 30 cm away.

A guiding track will indicate the anticipated forward or backward trajectory, depending on the gear that is engaged.

If an obstacle is located in the vehicle's way, the corresponding audible warning will sound.

¹⁾ The RVC button will only be displayed when reverse gear is engaged.

When the penultimate segment is displayed, the vehicle has reached the collision zone. In the collision zone, obstacles are shown in red (including those outside the trajectory). Stop the vehicle! **»»**  **in Description on page 163**

Rear park assist

Description


The rear park assist is an optical and audible assistant that warns of obstacles located behind the vehicle.

There are sensors integrated in the rear bumper. When they detect an obstacle, you are alerted by audible and visible warnings on the infotainment system.

Make particularly sure that the sensors are not covered by adhesives, residues, dirt and the like, as this could affect the system's operation. Cleaning instructions **»»** **page 306**.

The approximate measurement range of the rear sensors is:

- Side area: 0.60 m
- Central area: 1.60 m

As you approach the obstacle, the frequency of the audible signals will increase. The signal will sound continuously at around 0.30 m: Stop the vehicle! **»»**  **on page 163**.

If the separation is maintained, the warning volume is reduced after about 4 seconds.

Parking Aid connection


- Select reverse gear.

Parking Aid disconnection

- Drive forward at 15 km/h (9 mph) or faster.
- **OR**: place the selector level in position **P**, **N** or **D** [for automatic gearboxes] or disengage reverse [for manual gearboxes].

Set the lever to the **N** or **D** position to maintain the system active for approximately 8 seconds before switching off. During this time, the Parking aid will be deactivated if the selector lever is set to **P**.

Temporary sound suppression

- Press the  function button on the infotainment screen.

Change from reduced view to full view

- Select reverse gear.
- **OR**: on vehicles fitted with reverse assist [Rear View Camera "RVC"] press on the car icon of the reduced display.

Switch to the reverse assist image (Rear View Camera "RVC")

- Select reverse gear.
- **OR**: press the "RVC" function button.

Parking assist settings

The audio indications and signals are set in the infotainment system **»»** **page 35**:

- **Rear volume**: Volume in the rear area.
- **Reduce volume**: When the parking aid is switched on, the volume of the audio source will be reduced, depending on the selected option.
- **Rear sound settings/treble**: Sound tone in the rear area.

Error messages

If an error or fault message appears on the instrument panel in Parking assist, there is a fault.

If the fault doesn't disappear before disconnecting the ignition, it will not be indicated next time the parking aid is connected.


If there is a fault in a sensor, the  symbol is displayed on the infotainment system display.

We recommend taking the vehicle to a specialised workshop to have the fault repaired.

Towing device

In vehicles equipped with a towing bracket device from the factory, when the trailer is connected, the parking aid will not be activated when reverse gear is engaged.

WARNING

Observe the safety warnings **»»**  **in Description on page 163**.

Visual indication segments

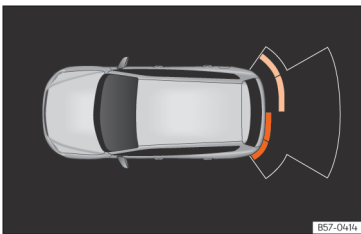


Fig. 122 Park assist view on the Infotainment system display.

The distance to obstacles can be estimated with the help of the segments at the rear of the vehicle.

The optical indication of the segments works as follows:

- **White segments:** the obstacle is more than approx. 30 cm away from the path or in the direction opposite to travel. They are also displayed when the parking brake is applied.
- **Yellow segments:** the obstacles lie on the vehicle's path and are at a distance of less than approx. 30 cm away.
- **Red segments:** obstacles are less than approx. 30 cm away.

If an obstacle is located in the direction in which the vehicle is travelling, the corresponding audible warning will sound.

When the penultimate segment is displayed, the vehicle has reached the collision zone. In the collision zone, obstacles are shown in red (including those outside the trajectory). Stop the vehicle! »» ⚠ in *Description* on page 163.

Park assist system (Park Assist)

Introduction

The assisted parking system is an additional function of ParkPilot »» page 162 and helps the driver find a suitable parking space from among the following types:

- reverse parking in suitable perpendicular and parallel spaces,
- park driving forwards in suitable perpendicular spaces,
- exit a parking space driving forwards from a parallel space.

In vehicles with a Park Assist system and factory infotainment system, the front, rear and side areas are represented, and the position of obstacles is shown relative to the vehicle.

The assisted parking system is subject to certain limitations inherent to the system and its use requires special attention by the driver »» ⚠.

⚠ WARNING

The technology used in the park assist system involves a series of limitations inherent to the system itself and the use of ultrasonic sensors. The use of Park Assist should never tempt you to take any risk that may compromise safety. The system is not a replacement for driver awareness.

- Any accidental movement of the vehicle could result in serious injury.
- Adapt your speed and driving style at all times to suit visibility, weather, road and traffic conditions.
- Certain surfaces of objects and garments do not reflect the ultrasound sensors' signals. The system cannot detect, at least correctly, these objects or people wearing such clothes.
- Ultrasound sensor signals may be affected by external sound sources. In certain circumstances this may prevent them from detecting people or objects.
- The ultrasound sensors may have blind spots in which obstacles and people are not detected.
- Monitor the area around the vehicle at all times, since the ultrasound sensors do not detect small children, animals or certain objects in all situations.

⚠ WARNING

Quick turns of the steering wheel when parking or exiting a parking space with Park Assist can cause serious injury.

- Do not hold the steering wheel during manoeuvres to park or exit a parking space until the system requests it. Doing so disables the system during the manoeuvre, resulting in the parking being cancelled.

ⓘ NOTICE

- In certain circumstances, the ultrasonic sensors do not detect objects such as trailer hitches, bars, fences, posts or thin trees, or an open (or opening) rear lid, which could damage the vehicle.
- Retrofitting of certain accessories to the vehicle, such as a bicycle rack, may interfere with the operation of the Park Assist system and cause damage.
- The Park Assist system uses as a reference parked vehicles, kerbs and other objects. Make sure that the tyres and wheels are not damaged while parking. If necessary, interrupt the parking manoeuvre on time to avoid damaging the vehicle.
- The ultrasound sensors on the bumper may be damaged or shifted in the event of a collision, for example, when entering or exiting a parking space.

- If you use high-pressure or steam equipment to clean the ultrasound sensors, do not apply it directly unless very briefly and always from a distance of more than 10 cm.
- A registration plate or plate holder on the front that is larger than the space for the registration plate, or a registration plate that is curved or warped can cause:
 - False detections.
 - The sensors to lose visibility.
 - Cancellation of the parking manoeuvre or defective parking.
- If one of the ultrasonic sensors is damaged, the area corresponding to that group of sensors (front or rear) is deactivated and cannot be activated until the fault is corrected. However, you can still use the sensors of the other bumper as per usual. If there is a fault in the system, consult a specialist workshop. SEAT recommends visiting a SEAT dealership for this.

ⓘ Note

- In order to guarantee good system operation, keep the ultrasound sensors of the bumper clean, free of snow or ice, and do not cover them with stickers or other objects.
- Certain sources of noise, such as rough asphalt or paving stones and the noise of other vehicles can induce the Park Assist system

or ParkPilot to give erroneous warnings. The presence of metal objects can also affect the manoeuvre.

- To become familiar with the system and its functions, SEAT recommends that you practice operating the Park Assist system in an area where there is not too much traffic or in a car park.

Description of the parking assist system



Fig. 123 In the centre console: button to switch on the Park Assist system.

The components of the Park Assist system are the ultrasonic sensors located in the front and rear bumpers, the **P** button to switch the system on and off and the messages on the instrument panel display.

Prerequisites for parking

- The traction control (TCS) must be switched on >>> page 133.
- Speed when passing next to the parking space (parallel parking): do not exceed approx. **40 km/h (25 mph)**.
- Speed when passing next to the parking space (angle parking): do not exceed approx. **20 km/h (12 mph)**.
- Keep a distance between **0.5 and 2.0 metres** when driving past the parking space.
- Space length (parallel parking): **vehicle length + 0.8 metres**.
- Space width (parking bay): **vehicle width + 0.8 meters**.
- Do not exceed approximately **7 km/h (4 mph)** when parking.

Requirements for leaving the parking space (only for parallel parking)

- The traction control (TCS) must be switched on >>> page 133.
- Space length: **length of the vehicle + 0.5 metres**.
- Do not exceed approximately **7 km/h (4 mph)** when exiting the parking space.

Prematurely stopping or automatically interrupting the manoeuvres for parking or exiting a parking space

Park Assist interrupts the manoeuvres for parking or exiting a parking space in any of the following cases:

- Press the **P** button.
- When exceeding a speed of approximately 7 km/h (4 mph) more than once.
- The driver takes control of the steering wheel.
- The parking manoeuvre does not end within 6 minutes after activation of the automatic steering.
- There is a fault in the system (the system is temporarily unavailable).
- TCS is switched off.
- TCS or ESC intervene with regulation.
- The driver door is opened.

To restart the manoeuvre it is necessary that none of these things occur and that the **P** button is pressed again.


Braking to avoid damage due to unsuitable speed

It is possible that the system operates the brakes to reduce excess speed. The parking manoeuvre can then continue. The brakes will intervene during each parking process.

Special characteristics

The Park Assist system is subject to certain limitations inherent to the system. For example, it is therefore not possible to use it to enter or exit a parking space on sharp bends or on very steep hills.

While entering or exiting a parking space, a brief signal sounds to prompt the driver to change between forward and reverse gears (depending on the case). In successive manoeuvres, the assistant tells the driver to change gears, at the latest, when the continuous audible signal is given (object present at a distance of ≤ 30 cm) by Park Pilot.

When the Park Assist system turns the steering wheel with the vehicle stationary, the instrument panel also displays the symbol . Keep the brake pedal depressed while the symbol remains on the dash panel display to turn the wheels with the vehicle stopped. This way, the system will require fewer manoeuvres to complete the parking action.

Trailer mode

The Park Assist system cannot be switched on if the factory-fitted towing bracket is electrically connected to a trailer.

After changing a wheel

If, after changing a wheel, the vehicle stops entering and exiting parking spaces correctly, the circumference of the new wheel may be different and the system may need to adapt to

it. The adaptation is automatic and takes place during driving. Making turns slowly and in both directions [20 km/h [12 mph]] for a few minutes may contribute to this adaptation process.

Selecting a parking type



Fig. 124 On the instrument cluster display: display of the assisted parking system with decreased visibility.

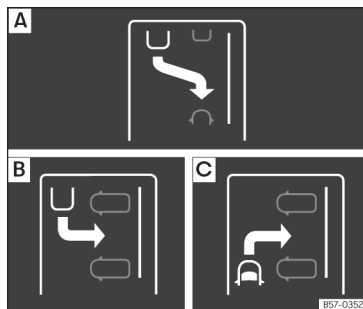


Fig. 125 On the instrument cluster display: parking modes indication.

Park assist has the following 3 parking types:

- A** Reverse parallel parking.
- B** Reverse angle parking.
- C** Forward angle parking.

Selecting a parking type after passing in front of the space

After activating the Park Assist system and after detecting a parking space, the instrument cluster display proposes a parking mode. The Park Assist system selects the parking mode automatically. The selected mode is shown on the instrument cluster display »» Fig. 124. The reduced display of other possible parking modes is also shown »» Fig. 125. If the mode selected

by the system does not correspond to the desired mode, you can select another mode by pressing the **P** button.

- The necessary conditions to park with Park Assist have to be met »» page 168.
- Press the **P** button.
- A control lamp on the **P** button lights up when the system is switched on. Additionally, the selected parking mode is shown on the instrument cluster display and the reduced display shows another parking mode it can be changed to.
- Turn on the corresponding turn signal towards the side of the road where you are parking. The instrument cluster displays the side corresponding to the road. By default, if the turn signal is not on, it parks on the right in the direction of traffic.
- If necessary, press the **P** button again to change to the next parking mode.
- Once you have switched to all possible parking modes, if the **P** button is pressed again, the system switches off.
- Press the **P** button again to switch the system back on.
- Follow the instructions shown on the instrument cluster display while paying attention to traffic and drive the vehicle past the parking space.

Parking in a parking bay without driving past first

Special case of forward parking in a parallel space without driving past first:

- The necessary conditions to park with Park Assist have to be met >>> **page 168**.
- Move forward towards the parking space while paying attention to traffic and stop the vehicle with the front part partially inside the parking space.
- Press the **P** button once.
- A control lamp on the **P** button lights up when the system is switched on. Additionally, the selected parking mode is shown on the instrument cluster display without reduced display.
- Let go of the steering wheel.

Parking with the parking assist system

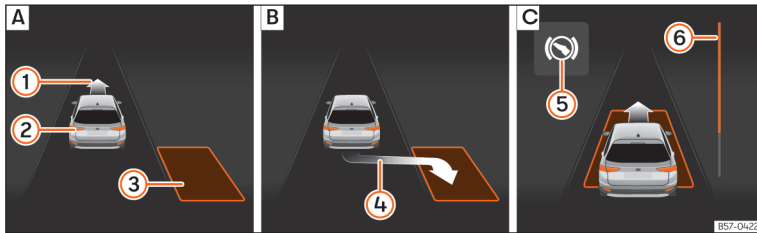


Fig. 126 On the instrument cluster display: angle parking. **A**: Finding a parking space **B**: Parking position. **C**: Manoeuvring.

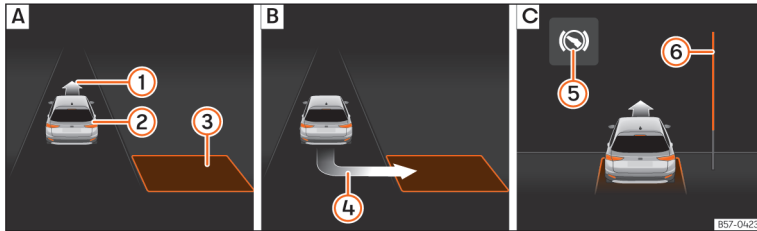


Fig. 127 On the instrument cluster display: angle parking. **A**: Finding a parking space **B**: Parking position. **C**: Manoeuvring.

- ① Message to move forwards
- ② Your vehicle
- ③ Parking space detected
- ④ Message to park
- ⑤ Message to press the brake pedal
- ⑥ Progress bar

The prerequisites have to be met to park with the parking assist system »» page 168 and the parking mode has to be selected »» page 170.

Parking

- Look at the instrument cluster screen to see if the space has been detected as “appropriate” and if the correct position for parking has been reached »» Fig. 126 **B** or »» Fig. 127 **B**. The space is considered “appropriate” if the instrument cluster display shows the parking indication ④.
- Stop the vehicle and, after a brief pause, engage the reverse gear.

- Let go of the steering wheel.
- Please note the following message:

Intervention in active steering. Watch your surroundings!

While keeping watch around you, carefully start accelerating up to no more than 7 km/h (4 mph). During the parking manoeuvre, the system **only** takes charge of the steering. **You,**

as the driver, have to accelerate, engage the clutch if necessary, change gears and brake.

- Reverse until the continuous ParkPilot signal sounds; **OR:** reverse until the indication to move forward appears on the instrument panel display >>> Fig. 126 [C] or >>> Fig. 127 [C]; **OR:** reverse until the **Park Assist finished** message appears on the instrument cluster display. The progress bar ⑥ indicates the distance to cover.
- Press the brake pedal until the parking assist system completes the steering wheel turns; **OR:** until the symbol (S) goes out on the instrument panel screen.
- Select first gear.
- Move forward until the continuous ParkPilot signal sounds; **OR:** move forward until the reverse indication appears on the instrument panel display. The Park Assist system steers the vehicle forward and back until it centres it in the space >>> Fig. 126 [C] or >>> Fig. 127 [C].
- For best results, wait at the end of each manoeuvre until the Park Assist system has finished turning the steering wheel. The parking manoeuvre ends when a corresponding message is displayed on the instrument panel and, in some cases, an acoustic signal sounds.

Progress bars

The progress bar >>> Fig. 126 ⑥ and >>> Fig. 127 ⑥ on the instrument cluster display shows the relative distance to be covered as a symbol. The greater the distance, the fuller the progress

bar. When driving forward, the content of the progress bar decreases upwards, and when reversing, it decreases downwards.

Note

If the manoeuvre is terminated prematurely during parking, the result may not be the best.

Leaving a parking space with the parking assist system (only for parallel parking)

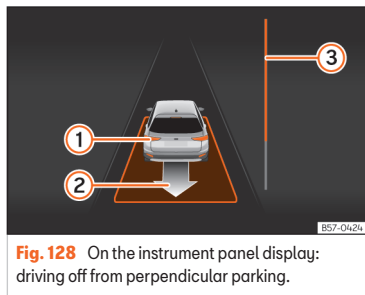


Fig. 128 On the instrument panel display: driving off from perpendicular parking.

- 1 Your vehicle in reverse gear
- 2 Message giving the proposed manoeuvre to exit the parking space
- 3 Progress bar to indicate the distance left to cover

Leaving a parking space (parallel parking)

The necessary conditions to exit a parking space with Park Assist have to be met >>> page 168.

- Press the P_{PA} button. A control lamp on the P_{PA} button lights up when the system is switched on.
- Turn on the corresponding turn signal towards the road you will enter when exiting the parking space.
- Select reverse gear.
- Let go of the steering wheel. Please note the following message:

Automatic steering enabled Pay attention to your surroundings.

While keeping watch around you, carefully start accelerating up to no more than 7 km/h (4 mph). When exiting the parking space, the system **only** takes charge of the steering. **You, as the driver, have to accelerate, engage the clutch if necessary, change gears and brake.**

- Reverse until the continuous ParkPilot signal sounds; **OR:** reverse until the instrument panel display shows the forward indication. The progress bar ③ >>> Fig. 128 indicates the distance to cover.
- Press the brake pedal until the parking assist system completes the steering wheel turns; **OR:** press the brake pedal until the symbol (S) goes out on the instrument panel screen.

- Move forward until the continuous ParkPilot signal sounds; **OR:** move forward until the reverse indication appears on the instrument panel display. The Park Assist system steers the vehicle forward and back until it can exit the space.
- The vehicle can exit the space when a corresponding message is displayed on the instrument panel and, in some cases, an acoustic signal sounds. Take charge of the steering with the turning angle set by the Park Assist system.
- Paying attention to the traffic, exit the parking space.

Reverse Assist (Rear View Camera)


Introduction

A camera installed in the rear lid handle assists the driver with reverse parking or manoeuvring
 >>> page 139.

The camera image is viewed together with orientation lines projected on the Infotainment System display. Part of the bumper can be seen at the bottom, which can be used by the driver as a reference point.

Reverse assist settings

Reverse assist offers the user the possibility to change the image's brightness, contrast and colour settings. To change these settings:

- Stop the vehicle in a safe place without switching off the ignition or the infotainment system.
- Apply the parking brake.
- Select reverse gear.
- Press the  function button displayed on the screen.
- Make the desired adjustments on the menu by pressing the -/+ function buttons or by moving the scroll button.

Requirements for parking and manoeuvring with reverse assist

The system should not be used in the following cases:

- If the image displayed is not very reliable or is distorted, or if the lens is dirty.
- If the area behind the vehicle is incomplete.
- If the vehicle is heavily loaded.
- If the position of the camera has changed after a rear-end collision. Have the system checked by a specialised workshop.

Familiarising yourself with the system

To familiarise yourself with the system, the orientation lines and their function, SEAT recommends practising in a place without too much traffic or in a car park when there are good weather and visibility conditions

WARNING

- **Reverse assist cannot precisely calculate the distance from obstacles and the limits of the system cannot be overcome, hence its negligent use may cause serious accidents and injuries if used without due care. The driver should be aware of his/her surroundings at all times to ensure safe driving.**
- **The camera lens expands and distorts the field of view and displays the objects on the screen in a way that is different from reality. Distance perception is also distorted.**
- **Due to the screen resolution or light conditions, some items may be blurry or not displayed at all. Take care with thin posts, fences, railings or trees that might not be seen on the screen and could damage the vehicle.**
- **Reverse assist has blind spots where it cannot see people or objects. Monitor the vehicle's surrounding area at all times.**
- **The system is not a replacement for driver awareness. Supervise the parking manoeuvre and the vehicle's surrounding area at all times.**
- **Do not be distracted from the traffic by looking at the screen.**

- The images are only two-dimensional. Protruding objects or holes in the road, for example, are more difficult to detect or may not be seen at all.
- Vehicle load modifies the representation of the guide lines. The width represented by the lines decreases with vehicle load. Pay special attention to the surroundings when the inside of the vehicle or the luggage compartment are loaded.
- In the following situations, objects or other vehicles appear to be further away or closer than they actually are. Pay special attention:
 - If moving from a flat surface to a slope and vice-versa.
 - If the vehicle is heavily loaded.
 - When the vehicle approaches objects that are not on the ground surface or that protrude from it. These objects may be outside the camera angle when reversing.

Note

- It is important to take great care and pay special attention if the driver is not familiar with the system.
- The reverse assist reference lines disappear when the rear lid is open.

Shown on the display

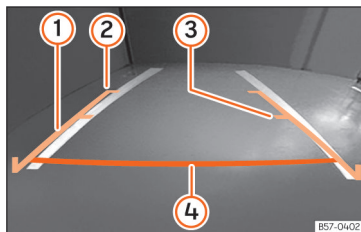


Fig. 129 Infotainment system display: guidance lines.

- ① **Lateral lines:** extension of the vehicle (approximately its total width) on the road.
- ② **End of the side lines:** approx. 2 m behind the vehicle on the road.
- ③ **Intermediate line:** approx. 1 m behind the vehicle on the road.
- ④ **Horizontal red line:** a safe distance of approx. 40 cm at the rear of the vehicle on the road.

Switching the system on and off

- Reverse assist is connected by a contact when engaging reverse gear.
- The system switches off 8 seconds after disengaging reverse gear and immediately after turning off the ignition.
- The camera will stop transmitting images above the speed of 15 km/h (9 mph) with reverse engaged.

In combination with the park assist plus system **>>> page 162**, the camera image will no longer be displayed when reverse gear is disengaged, and the system will display the optical information provided by the park assist system.

It is also possible to hide the reverse assist image:

- By pressing one of the Infotainment system buttons on the display.
- **OR:** by pressing on the miniature vehicle shown on the screen.

If you wish to display the rear assist image again:

- Disengage and re-engage reverse gear.
- **OR:** Press the RVC function button¹⁾.

¹⁾ The RVC button will only be displayed when reverse gear is engaged.

Parking manoeuvre

- Stop the vehicle in front of a space and select reverse gear.
- Reverse slowly, and turn the steering wheel so that the side lines lead towards the parking space.
- Guide the vehicle into the parking space so that the side lines run parallel to it.

Rear Cross Traffic Alert¹⁾

How it works



Fig. 130 Diagram of the parking assistant: detected area around the vehicle that is driving off.

Park Assist uses the radar sensors on the rear bumper »» page 137 to monitor traffic crossing behind the vehicle as it reverses out of a parking bay, or as it is being manoeuvred, for example in very low visibility conditions.

When the system detects a relevant vehicle on the road that is approaching the rear of the vehicle »» Fig. 130, an acoustic alarm may sound if the relevance so requires it.

In addition to the acoustic alarm, the driver is also informed by means of a visual signal on infotainment system display. This signal is displayed in the form of a red strip at the back of the image of the vehicle on the infotainment system screen. This strip displays the side of the vehicle towards which traffic is approaching in transverse direction¹⁾.

Automatic braking to reduce damages

»» page 160.

Connecting and disconnecting

The rear cross traffic alert can be switched on and off by accessing the **Assistants** menu on the dash panel display using the steering wheel controls. If the vehicle is equipped with a multi-function camera, it can also be accessed by means of the assistants systems key located on the main beam headlight lever.

When the vehicle is restarted, the last adjustment in the system will remain active.

Trailer mode

The rear cross traffic alert will be automatically deactivated and it will be impossible to activate them if the tow hitch is electrically connected to a trailer or other similar object. As soon as the driver starts driving, a message appears on the instrument cluster screen indicating that the assistant is deactivated.

Once the trailer is uncoupled from the vehicle, the assistant will return to its initial state prior to the moment when the trailer was electrically connected.

If the tow hitch is not factory fitted, then the rear cross traffic alert will have to be deactivated manually when driving with a trailer.

⚠ WARNING

The smart technology incorporated into the rear cross traffic alert cannot overcome the limits imposed by the laws of physics; it only works within the limits of the system. The parking assistant function should not tempt you into taking any risks. The system is not a replacement for driver awareness.

- The system should never be used in limited visibility conditions or complicated traffic, e.g., in high-traffic areas or when crossing multiple lanes.

¹⁾ It is only displayed if the vehicle is equipped with a parking system.

- Be sure to always be aware of the vehicle's surroundings, since the system often fails to detect things such as bicycles or pedestrians.
- The rear cross traffic alert itself will not brake the vehicle to a complete stop.

Practical equipment

Storage compartment

Introduction

Use the storage compartments only for small or light items.

⚠ WARNING

Objects inside the vehicle that are not secured could be thrown across the vehicle interior in the event of sudden braking or manoeuvring. This may cause severe injuries as well as loss of control of the vehicle.

- Do not carry animals or sharp, hard or heavy items in open storage compartments of the vehicle, on the dashboard or on the cover behind the rear seats, or inside pieces of clothing or bags inside the vehicle.
- Keep the storage compartments closed at all times while the vehicle is in motion.
- Do not hang garments weighing more than 2.5 kg (approx. 5.5 lb) on the vehicle's coat hooks. Never leave heavy, hard or sharp objects in the pockets of these pieces of clothing.

⚠ WARNING

If you leave lighters inside the vehicle, they might be damaged or lit inadvertently. This could lead to severe burns and damage to the vehicle.

- Before moving a seat, make sure there are no lighters in the moving part area of the vehicle.
- Before closing a storage compartment, make sure there are no lighters in the closing area.
- Never leave a lighter inside a storage compartment or any other surface of the vehicle as it could ignite due to the high temperatures on such surfaces, particularly during the summer.

ⓘ NOTICE

- Do not store heat- or cold-sensitive objects, food or medicines in the vehicle interior. Heat and cold could damage them or render them useless.
- Objects made from transparent materials left inside the vehicle, such as glasses, magnifying glasses or transparent suction pads stuck to the windows can concentrate sunlight and damage the vehicle.

Glove compartment



Fig. 131 On the passenger side: glove compartment.

Opening and closing the glove compartment

Opening: Pull the handle »» Fig. 131 and open the glove compartment.

Closing: Press the glove compartment upwards.

⚠ WARNING

If the glove compartment is left open, the risk of causing severe injuries in the event of an accident, sudden braking or manoeuvring increases.

- Always keep the glove compartment closed while the vehicle is in motion.

Drink holder

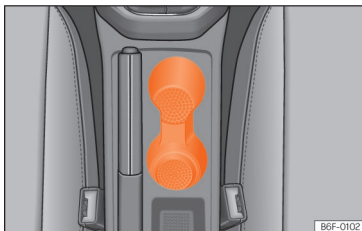


Fig. 132 Front drink holders in the centre console.

The storage compartments of the driver and passenger doors contain a bottle holder.

Front drink holders

There are two cup holders in the centre console.

WARNING

Incorrect use of the bottle holders may cause injuries.

- Never put hot drinks in the drink holders. In the event of sudden braking or an accident while driving, hot beverages in the bottle holders might spill and cause burns.

- Ensure that no bottles or other objects are dropped in the driver footwell while driving, as they could get under the pedals and obstruct their working.
- Never place glasses, food or other heavy objects drink holders. These heavy objects may be thrown across the cabin in the event of an accident and cause serious injuries.

WARNING

Closed bottles may explode inside the vehicle due to cold or heat.

- Never leave closed bottles in the vehicle if the temperature inside is very high or very low.

NOTICE

Do not leave open cans in the drink holders when the vehicle is in motion. If the drink is spilled (e.g. due to sudden braking) it may damage the vehicle and its electrical system.

Note

The inside elements of the drink holders can be extracted for cleaning.

Storage compartment under front seats

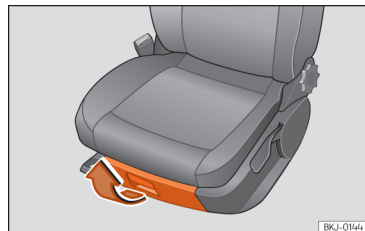


Fig. 133 Storage compartment under the right front passenger seat.

Opening: Press the tab on the drawer handle and take the drawer out.

Closing: Push the drawer under the seat until it engages.

Depending on the equipment, under the driver's seat there may be a magazine holder (about the size of the instruction manual) instead of the storage compartment.

WARNING

If the drawer is left open, it could prevent use of the pedals. This may cause serious accidents and injuries.

- Always keep the drawer closed while the vehicle is in motion. Otherwise, the drawer and any objects in it could fall into the driver's footwell and obstruct the pedals.

NOTICE

The drawer can contain 1.5 kg at most.

Other object holders

You will find more object holders, compartments and supports in other parts of the vehicle:

- In the centre console.
- Inside the central armrest.
- Other storage compartments are found in the rear seat, to the left and the right of the seats.
- In the backrests of the front seats, storage pockets.
- In the luggage compartment, on both sides, there may be hooks for hanging light bags.

There are hangers on the struts of the doors and the rear.

WARNING

Hanging clothes may decrease the driver's visibility, which may cause serious accidents and injuries.

- Always hang clothes from hangers in such a way that the driver's visibility is not affected.
- Only hang light pieces of clothing from the hangers of the vehicle. Never leave heavy, hard or sharp objects in the pockets of these pieces of clothing.
- Do not use clothes hangers to hang up the clothing, as this could interfere with the function of the head-protection airbags.

NOTICE

Do not place overly large objects in the pockets on the front seat backrests (e.g. bottles) or objects with sharp edges. Risk of damage to the pockets and the upholstery.

Power sockets

Introduction

Electrical equipment can be plugged in to the vehicle's sockets.

The devices must be in a perfect state of repair. Do not use defective devices.

The 12 volt power socket will only work with the ignition on.

WARNING

Improper use of the sockets or electrical devices could lead to a fire and cause serious injuries.

- Please ensure that children are never left unsupervised inside the vehicle. The sockets and the devices connected to them can be used when the ignition is switched on.
- If electrical devices overheat, switch them off immediately and disconnect them from the power supply.

NOTICE

- To avoid damaging the electrical system, never connect electrical devices that supply power, such as solar panels or battery chargers, to 12-volt sockets to charge the 12-volt battery.
- Only use electrical devices that comply with the applicable electromagnetic compatibility directives.
- To prevent voltage fluctuations from causing damage, unplug any connected electrical devices before switching the ignition on and off.
- Never connect electrical devices that consume more than the specified power to a 12 volt socket. Exceeding the maximum power consumption could damage the vehicle's electrical system.
- Observe the instruction manuals of electrical devices!

Note

- The use of electrical appliances with the engine switched off will cause the 12-volt battery to discharge.
- Uninsulated devices can interfere with the radio, infotainment system and the vehicle's electronic system.

NOTICE

If the 12-volt socket is used at full power for longer than the specified time, the fuse may blow.

- Never use the 12-volt socket at full power for more than 10 minutes.

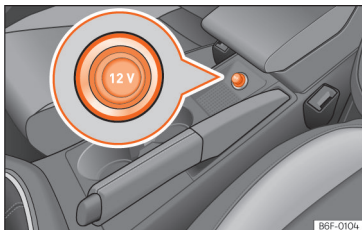
Vehicle power sockets

Fig. 134 Vehicle 12-volt socket.

- Remove the plug from the socket located in the centre console »» **Fig. 134**.
- Insert the plug of the electrical appliance into the power socket.

Electrical equipment can be connected to the 12 volt power socket.

The appliances connected to each power socket must not exceed a power rating of 120 Watt.

Data transmissions

Over-the-air update

Introduction

Over-the-air updates allow you to always keep your vehicle up to date, for example for optimising functions and for malware protection.¹⁾

How can you find out when an over-the-air update is available?

The available updates are displayed in the information system.

If several updates are available for the vehicle at the same time, one over-the-air update must first be successfully completed before the next one can be performed.

Note

Over-the-air updates require your vehicle's connectivity to be enabled.

It is in your own interest to complete updates as soon as possible. If the controller repeatedly rejects the over-the-air update, it will be necessary to visit a qualified workshop. SEAT recommends using a SEAT dealer.

WARNING

In very rare cases, a control unit may not function properly after an over-the-air update. Malfunctioning of a control unit and the vehicle can lead to serious accidents and fatal injuries.

- Reduce speed in a controlled manner if the vehicle operates or reacts differently than usual while driving.
- Contact a specialised workshop. SEAT recommends using a SEAT dealer.

WARNING

If the instrument cluster does not work after an over-the-air update, you will not be able to see instrument cluster displays, warning lights, symbols or text messages. Driving with an instrument cluster that does not work can lead to serious accidents and fatal injuries.

- Do not use the vehicle. Please contact the SEAT customer care service.

NOTICE

If special modifications have been made to vehicles outside the scope of SEAT's responsibility (for example, for emergency service vehicles or taxis), there is a risk that special functions (e.g. the taximeter) may no longer work properly after an over-the-air update.

- Consult with your SEAT dealer before performing an over-the-air update.


Note

- Measures to improve performance or efficiency (e.g. engine tuning) that have not been incorporated by SEAT may be deleted after an over-the-air update.
- Depending on the equipment, release notes may appear once before or after an over-the-air update. These release notes describe changes to the vehicle status. For release notes and more information on over-the-air updates, please visit the website:

www.seat.com

- The over-the-air update will not update apps installed in the vehicle.
- Certain information, such as your VIN (vehicle identification number), may be shared with the brand to ensure that each of these campaigns is successful. These updates will require your final confirmation before installation. If you do not wish to receive them,

¹⁾ Not available in all markets.

you can change your privacy to  Incognito (maximum privacy) mode in the **privacy and services settings** >>> page 189.

Prerequisites for an over-the-air update

The following prerequisites must be met to allow an update to be downloaded via satellite and to install the update software.

- The over-the-air update function is available in your country.
- The vehicle is located in an area with sufficient mobile reception.
- Your current privacy configuration allows you to transmit and receive data and information >>> page 189.
- The vehicle's 12-volt battery is properly charged.

Download and install an over-the-air update

Download costs

Over-the-air updates are downloaded via the factory control unit with eSIM card, and are free of charge. SEAT covers the cost of the connection.

Download timing

Downloading takes place automatically without warning and may also happen while driving. When the download is complete, a message will appear to inform you that an over-the-air update is available.

Note

The duration of the download process depends on the quality of the network, the file size and the type of update. The download process may be interrupted. It will resume when the ignition is switched on again.

Software installation pre-requisites

- The vehicle is parked safely in accordance with legal requirements and local regulations >>> page 159.
- Previous over-the-air updates have been installed.

Installing the software from an over-the-air update

Choose a time for the over-the-air update when neither you nor others are likely to be driving the vehicle.

WARNING

The control units will be switched off and will not work while the software installation is in progress. Driving while the control units are switched off or faulty can lead to accidents and fatal injuries.

- **Install the software in a way that does not interfere with other road users.**
- **Do not use the vehicle during a software installation procedure.**

1. Deactivate the vehicle's drive system and apply the electronic parking brake.
2. Close the bonnet, luggage compartment, all windows and all doors.
3. Confirm the software installation in the Infotainment system.
4. Ensure that all vehicle occupants get out and that there are no animals left inside.
5. Collect all vehicle keys and get out.
6. Lock the vehicle.

Functional restrictions during software installation

The control units, central computer, functions and displays will not be available during the software installation. Do not use the vehicle or the Infotainment system during installation.

- The system prevents the activation of the vehicle's drive system.
- The AUX-IN diagnostic socket is switched off.
- The anti-theft alarm is switched off.
- The "Safe" security system is switched off.

After installing the software

After the software installation and before activating the vehicle's drive system, read the message on the Infotainment system or in the Instrument cluster about the complete installation of the software. It can take up to 1 minute for the vehicle to display the status of the over-the-air update.

- The vehicle's drive system can be activated once the software has been successfully installed.
- If the software installation is not successful:
»» **page 184, Troubleshooting.**

Troubleshooting

The installation of an over-the-air update has failed.

- If an update is not installed correctly, an error message will appear in the infotainment system or in the instrument cluster. Observe the corresponding messages and warnings.

Note

The control units will stop working or will not work properly in the event of a critical installation error. The functions and screens will not be available until the error is amended. Do not use the vehicle. In this case, please contact SEAT customer care.

Can I interrupt the installation of an over-the-air update?

Not possible.

What happens if the installation of an over-the-air update is interrupted?

If the installation is interrupted, for example due to damage to the vehicle's electrical system, the control units may not be updated and may not work due to incomplete installation of the update.

SEAT CONNECT

Introduction

Access SEAT CONNECT Gen3 digital services by connecting your vehicle to the Internet. A description of the available services can be found on the Internet at:

<https://www.seat.com/owners/connectivity/seat-connect-service>

To use SEAT CONNECT Gen3, you have to activate the services by concluding a CONNECT contract with SEAT, S.A., which may be subject to usage time limitation depending on the country.

Both the SEAT CONNECT service portfolios offered by SEAT and individual services can be modified, cancelled, deactivated, reactivated, renamed and extended, even without prior notification.

The execution and availability of the SEAT CONNECT services and service portfolios may vary depending on the country, as well as the vehicle, its equipment and connectivity.

SEAT CONNECT's voice recognition or search technology does not recognise or offer results for all words.

There are SEAT CONNECT services for which registration is mandatory and others for which it is not mandatory.

Description of services

Before running SEAT CONNECT services, read and take into account the description of the corresponding services. Descriptions are updated on a non-periodical basis.

- Always use the most up-to-date version of the corresponding service description.

⚠ WARNING

In areas with insufficient mobile phone and GPS coverage, emergency calls and phone calls will not be connected and data cannot be transmitted.

- Change location if possible.

📌 NOTICE

The vehicle may be damaged by factors outside the control of SEAT, S.A. These damaged can include:

- Misuse of mobile terminals
- Data loss during transmission.
- Unsuitable or defective third party applications.
- Malicious software on data storage devices, computers, tablets or mobile phones.

Services portfolio

The initial service assignment shown here represents the maximum possible volume. The maximum possible volume is only available on a few vehicle models. During the useful life of the vehicle, you can change the assignment shown here.

After activating service management in the infotainment system, you can check whether services are available for the vehicle and what services they are **»» page 188**.

In some countries and in the event of a contract renewal, the services offered may be combined differently than indicated here. They may also vary depending on the year of production of the vehicle. The services mentioned correspond to **SEAT CONNECT Gen3** (third generation).

SEAT CONNECT services and functions that do not require activation

The following services also work without the activation of SEAT CONNECT:

- Public emergency call service.
- Legal.
- Privacy mode [deactivation of services].

SEAT CONNECT Gen3 services

If your vehicle is fitted with Media System + or Navi System +, your online services package is SEAT CONNECT. The following services are included¹⁾:

- Public emergency call.
- Breakdown call.
- Customer care.
- Service appointment planning.
- Customisation.

- Activating SEAT CONNECT.
- Privacy mode and deactivation of services.
- Delete user / Restore factory settings.
- Remote auxiliary ventilation and heating.
- Remote unlock.
- Horn and turn signals.
- Vehicle status incl. doors and lights.
- Driving data.
- Vehicle health report.
- Anti-theft alarm warning.
- Zone notification.
- Speed notification.
- Online map update.
- Dictation.
- Natural voice control for destinations and addresses.
- Internet radio.
- Online route import.
- Online destination import.
- Remote auxiliary ventilation.
- Parking position.
- Legal.
- Data package.
- Online Store.
- Online navigation: Dynamic Points of Interest

¹⁾ Some services may be subject to special equipment.

If your vehicle is fitted with Navi System +, it also has the SEAT CONNECT PLUS online services package. The included services are all the SEAT CONNECT services in the previous section plus¹⁾:

- Search for public car parks.
- Search for petrol stations.
- Online route calculation.
- Online traffic information.

SEAT CONNECT individual options




- In-Car Applications. These applications can be purchased and installed directly in the infotainment system through the In-Car store.
- Full Link.
- Data package. Pay per use data rates for the use of online functions, for example, 2 GB per month.

Note

- **The public emergency call service is available regardless of whether the infotainment system is logged in.**
- **Customisation and purchase of In-Car applications require logging into infotainment system, but the activation of the vehicle in a SEAT CONNECT account is not necessary.**

Activation of SEAT CONNECT and S-PIN

The following steps are necessary to activate SEAT CONNECT Gen3 (including registration):

1. Switch on the ignition and the infotainment system.
2. Change the privacy mode to "Tracking"
»» page 189.
3. Select:  >  **Users** and press the button  to add a new user.
4. Follow the on-screen instructions to download the My SEAT App.
5. Follow the instructions to create your SEAT ID.
6. Accept the Privacy Policy.
7. Enter the vehicle identification number (VIN) to add the vehicle to your user account.
8. Check your personal details.
9. Select your SEAT CONNECT online services pack.
10. Open the app and scan the new QR code generated by the infotainment system.

Follow the rest of the indications and the information shown in the infotainment system. During activation, you may be asked to create an S-PIN.

S-PIN

The S-PIN is a sequence of several digits, which can be selected when completed the SEAT CONNECT registration.

When creating the S-PIN, avoid easy-to-guess number sequences and known dates of birth. You can change the S-PIN in the SEAT CONNECT user account in "Account settings".

The S-PIN is necessary, for example, to protect your user profile or to run a SEAT CONNECT service relevant to the security of your vehicle. You must manage this S-PIN with absolute confidentiality.

If you reveal the S-PIN to third parties, for security reasons you must change it immediately.

Ownership and identity accreditation

Depending on the Infotainment system, the ownership accreditation method will be the 2-key method or the registration code method.

9.2" Infotainment system

To become a primary user and thus prove ownership of the vehicle, you need both of the vehicle's physical keys. Ownership accreditation takes place in the vehicle during registration or,

¹⁾ The above services may be subject to a subscription period.

if you already have a SEAT CONNECT user account, you must log in through the infotainment system and then go to **User management**.

- Switch on the ignition and the infotainment system.
- In the infotainment system, register in SEAT CONNECT.
- **Or:** open the menu **Manage users > Settings > Become primary user** and follow the instructions.
- Press the unlock button on the first vehicle key.
- Press the unlock button on the second vehicle key.

8.25" Infotainment system

To become the primary user and therefore accredit ownership of the vehicle, you will need the registration code found on the SEAT website and in the My SEAT App after linking the vehicle to your account (**My Garage > Add Vehicle > Accept terms and conditions and SEAT privacy policy**). Ownership is accredited inside the vehicle. Go to **Vehicle settings > SEAT CONNECT > Registration** and enter the pairing code shown in the My SEAT App

Once the infotainment system has processed the orders by radiofrequency, the accreditation of the ownership will have been completed. You can check the current status in the My SEAT App.

How is ownership accredited?

9.2" Infotainment	2-Key method.
8.25" Infotainment	Pairing code.
My SEAT App	No, it is not possible

Identity accreditation (SEAT ID)

Identity accreditation must be done before you can use SEAT CONNECT services that are relevant to security, such as the "Remote Opening" service. Identity accreditation can be done in two ways:

- In person at the SEAT dealership.
- More information on SEAT ID is available in the My SEAT App.

Legal provisions

During the use of SEAT CONNECT services, information is transferred and processed online through the vehicle. Such data can also provide (at least indirectly) information about the driver in question, for example, driving behaviour and location. As a contracting party in the SEAT CONNECT contract with SEAT, S.A., you must ensure that when your vehicle is used by other drivers (for example, family or friends), data protection and personal rights are respected. Therefore, you must inform drivers in advance that the vehicle transfers and receives data online, and that you can access such data.

Not taking into account this obligation to inform, can infringe certain rights of the occupants.

Users can manage data sending and transfers through the privacy mode at any time.

Follow-up services: ask all occupants

The follow-up services need geographical and vehicle data to determine whether the vehicle is being used within defined speed ranges, where it has been parked or if it is being used in an established geographical area. This information is displayed in the My SEAT App.

Therefore, before moving off, ask all the vehicle occupants if they agree with the activated services. If they do not, deactivate the service in question (if possible) or do not allow the occupants to use the vehicle.

GPS tracking: marking

If the vehicle has a factory-fitted control unit that transmits its current geographical position and speed, the vehicle usually has this GPS marking, e.g. on the ceiling console. The absence of the marking on the vehicle does not guarantee that the control unit does not transmit the vehicle's current geographical position and speed.

Personal information

SEAT protects your personal data and only uses them, as long as the law allows it or you have given your consent on the occasion of a

use. You will find detailed information on data processing in relation to SEAT CONNECT services in the Privacy Policy, which you can access in its corresponding current version on the SEAT website.

Permanent transfer of the vehicle

If the vehicle has been purchased used or someone else has left the vehicle to you for permanent use, SEAT CONNECT may already be activated and the previous primary user may still be able to access the data registered via SEAT CONNECT and control certain functions of your vehicle.

You can automatically remove the previous primary user by registering yourself as the primary user of the vehicle. Alternatively, you can restore the infotainment system to factory settings (⚙️ > **Restore factory settings**) or set the vehicle to "Incognito" mode (maximum privacy) and therefore limit both your vehicle's communication with the SEAT, S.A. data service and the processing of personal and vehicle data.

Deactivating SEAT CONNECT services

The following functions are available to activate and deactivate the SEAT CONNECT services:

- Allow or prevent data transmissions through the infotainment system >>> **page 189, Privacy mode.**
- Whenever possible: individual deactivation or activation >>> **page 188.**

You can run the relevant services again after cancelling their deactivation.

Note

The services required by law and their data transmission cannot be disconnected or deactivated, for example, the emergency call system (eCall).

Faults

Even if the prerequisites for the use of SEAT CONNECT services are met, there may be factors beyond the control of SEAT, S.A. that interfere with the execution of such services or prevent them, specifically including:

- Maintenance, repair, deactivation, software update and technical expansion of telecommunication equipment, satellites, servers and data banks.
- Change of the mobile telephony standard for the transmission of mobile data by the telecommunications service provider, for example, from UMTS to EDGE or GPRS.
- Disconnection of an existing mobile phone standard by the telecommunications service provider.

- Interference, disturbance or interruption in the reception of the mobile phone and GPS signal due to aspects such as high-speed driving, solar storms, meteorological influences, topography, blocking equipment and the intensive use of mobile phones in the radio cells in question.
- When in areas with zero or insufficient mobile telephony or GPS signal. Also, for example, in tunnels, confined areas between very tall buildings, garages, underpasses, mountains and valleys.
- External information from third party suppliers available with limitations, incomplete or incorrect, e.g. representations of maps.
- Countries and regions where SEAT CONNECT is not offered.

Service management

Open the settings in **Users** and go to **Privacy settings and services**. In vehicles fitted with the 9.2" Infotainment, it is accessed from **Users > Settings > Private Mode (deactivation of services)**. In vehicles equipped with the 8.25" Infotainment it is accessed from **Settings > SEAT Connect > Privacy settings and services**. You can do the following in the infotainment system:

- Check which SEAT CONNECT services are currently available in the vehicle.
- The number of SEAT CONNECT services that are enabled or disabled.
- Activate or deactivate SEAT CONNECT services.

Note

If you deactivate all SEAT CONNECT services, the vehicle can still transmit emergency call (eCall) data.


Privacy mode

Introduction

With the "Privacy" function, data transmissions between the vehicle and the Internet can be allowed or blocked.

Please note that your vehicle is connected by default, so that it can receive remote updates that improve the performance of your vehicle.

Certain information, such as your VIN (vehicle identification number), may be shared with the brand to ensure that each of these campaigns is successful. These updates will require your final confirmation before installation. If you do not wish to receive them, you can change

your privacy to  **Incognito** (maximum privacy) mode in the privacy and services settings **>>> page 189**.

The desired mode can be set in vehicle settings in the infotainment system.

Data transmission by external devices and their communication with the vehicle **cannot** be blocked using the "Privacy" function.

The services required by law and their data transmission cannot be disconnected or deactivated, for example, the emergency call system (eCall).

Note





Please note that all vehicle users can configure individual settings in the "Privacy" function. These settings may not match those desired by the vehicle owner.

Privacy and services settings

SEAT CONNECT services can be activated and deactivated individually. To do this, just check the box corresponding to the service you want to activate or deactivate. Use the privacy mode option if you want to deactivate all of the services at the same time.

Privacy mode.

Allows you to deactivate or activate the services depending on the selected privacy level.

 Tracking	Share location. Primary users and co-users can view position data on the My SEAT App.
 Location	Use location. Position, vehicle, and user data are used for services.
 Personal	No location. Only the vehicle data and user data are used for services.
 Privacy	Maximum privacy. Your services are disabled. Only services required for legal reasons use data.

Setting options are not available in all markets or in all vehicle models.

Connectivity status indication

The following symbols indicate the respective data transmission status in the infotainment system.



Symbol white: full connectivity, all services available



Symbol grey: limited connectivity, some services may not be available.

no icon No connectivity, no services available.

WLAN access point

Introduction

The infotainment system can be used to share a WLAN¹⁾ connection with up to 8 devices »» page 190, *Configuration for sharing a connection over WLAN*.

The infotainment system can also use the WLAN hotspot of an external device to provide Internet to the devices connected to the hotspot (WLAN client) »» page 190.

Note


• There may be a charge for the required data transmission. Due to the high volume of data exchanged, SEAT recommends the use of a flat rate tariff for data transmission. Mobile phone operators can provide information on this. You can also purchase data plans for your vehicle on the Cubic website:

<https://seat.cubiclecom.com>

• Exchanging data packages and purchasing them from third parties may generate additional costs, depending on your mobile phone rate, particularly if you are abroad [for example, roaming rates].

Configuration for sharing a connection over WLAN

Establishing the connection with the wireless network (WLAN)

- Press the **HOME** >  button.
- Activate the wireless network. To do this, press the function button **Wi-Fi** > **Infotainment system as hotspot**.
- Activate the wireless network (WLAN) on the device that is to be connected. If necessary, refer to the manufacturer's instruction manual.
- Activate the mobile device assignment in the infotainment system. To do this, press the function button **Use as hotspot** and check the checkbox.
- Enter and confirm the network key displayed on the device.

The following adjustments can also be made in the **Infotainment system as hotspot** menu:

- **Security level:** With WPA2/WPA3 encryption, a network key is automatically generated.
- **Network key:** Network key generated automatically. Press the function button to change the network key manually. The network key must have at least 8 characters and a maximum of 63.
- **SSID:** Name of the WLAN network (maximum 32 characters).

The WLAN (wireless) connection is established. To complete the connection, it may be necessary to enter other data into the device.


Repeat this process to connect other devices.

There is also the option of scanning the QR code to connect the device directly to the infotainment system's Wi-Fi network without having to enter the password: select **Settings** > **Wi-Fi** > **Quick connection to infotainment system**.

Configure Internet access

The infotainment system can use the WLAN hotspot of an external device to establish an Internet connection.

Establishing the connection with the wireless network (WLAN)

- Activate and share a wireless hotspot with Internet on the external device. Refer to the manufacturer's instruction manual.
- Press the **HOME** >  button.
- Press the **Wi-Fi** > **Connect to Wi-Fi** menu and put a check in the checkbox.
- Press the **Search for Wi-Fi** button and select the device you want from the list.

¹⁾ Not available in all markets.

The system preferentially searches for devices in the 5 GHz Wi-Fi band. If no results are found, it is advisable to check the device's access point settings.

- If necessary, enter the network key of the device in the infotainment system and confirm with **OK**.

Manual settings:

- To manually enter the network settings of an external (WLAN) device.

The WLAN (wireless) connection is established. To complete the connection, it may be necessary to enter other data into the device.

Note

Due to the large number of devices on the market, it is not possible to guarantee fault-free operation of all functions.

Full Link

Introduction

With Full Link it is possible to view and use the contents and functions that are shown on the mobile phone device on the infotainment screen.

To do this, the mobile phone device must be connected with the infotainment system through a USB interface.

Some technologies can also be used by Wireless Full Link through the Bluetooth® interface and a Wi-Fi connection.

The following technologies may be available:

- Apple CarPlay™
- Apple CarPlay™ Wireless
- Android Auto™
- Android Auto™ Wireless

The availability of the technologies that Full Link includes depends on the country and the mobile phone device used.

You can find more information on the SEAT website (www.seat.com).

Access the Full Link main menu

Browsing the Full Link main menu depends on the infotainment system used.

- Press **HOME > Full Link**.

Configure Wireless Full Link

In order to use Wireless Full Link, you must first pair the mobile phone device with the infotainment system. To do this, proceed as follows:

Connect a mobile phone device for the first time.

- Unlock the mobile phone device.
- Enable Wi-Fi reception and Bluetooth® on the mobile phone device.

- Connect the mobile phone device to the infotainment system using a USB cable or via Bluetooth®.

- Access the **Full Link** main menu, if it is not displayed automatically.

- Select the mobile device and the technology you want.

- Confirm authorisation inquiries on the mobile phone device to grant the necessary authorisations to the infotainment system.

- Disconnect the USB connection and connect with the infotainment system again via Wi-Fi or Bluetooth®. Wireless Full Link is now configured.

The pairing has concluded. The connected mobile phone device can also use Wireless Full Link from now on without the USB connection.

If pop-up menus are rejected during the connection process, Wireless Full Link will not be available. In this case, SEAT recommends deleting the devices in both the telephone settings and the infotainment system, and restarting the connection process.

Bluetooth pairing®

You can connect your device to the infotainment system via Bluetooth®.

If the device is compatible, the system will inform you that you can connect your device to Apple CarPlay™ or Android Auto™ as appropriate.

⚠ WARNING

The use of applications while driving can distract your attention from the traffic. Any distraction affecting the driver in any way can lead to an accident and cause injuries.

- Always drive with attention to traffic and in a responsible manner.

⚠ WARNING

Any applications that are not suitable or execute incorrectly may cause damage to the vehicle, accidents and serious injuries.

- Protect the mobile phone device and its applications from inappropriate use.
- Never make modifications to the applications.
- Follow instructions in the instruction manual for the mobile phone device.

ⓘ NOTICE

SEAT cannot be held liable for any damage caused to the vehicle as a result of the use of applications that are of poor quality or are defective, inadequate programming of the applications, insufficient coverage of the network, loss of data during transmission or improper use of mobile phone devices.

ⓘ Note

- Wireless Full Link may not be compatible with all technologies.
- When crossing the border into countries with permitted radio frequencies different to those in your own country, running the Full Link Wireless function may be restricted or even unavailable due to legal regulations. This may also be indicated by a message in the infotainment system. Running Full Link via cable is not affected by this restriction and it can continue to be used.

Applications (apps)

With SEAT Full Link, the display of the contents of SEAT applications and other providers installed on mobile phone devices can be transferred to the infotainment screen.

In the case of third-party applications, there may be compatibility problems.

Applications, their use and the necessary mobile phone connection may be pay per use.

The applications on offer can be varied and designed for a vehicle or a specific country. The content and volume of applications, as well as the companies that offer them, may vary. Some applications also depend on the availability of third-party services.

It cannot be guaranteed that all the applications offered will work on all mobile phone devices or with all their operating systems.

The applications offered by SEAT can be modified, cancelled, deactivated, reactivated and extended without prior notification.

To avoid distracting the driver while driving, only certified applications can be used.

Full Link symbols and settings

- ℹ** To show more information.
- 📱** To select Apple CarPlay technology.
- 🗺** To select Android Auto™ technology.

Apple CarPlay™

In order to use Apple CarPlay™, the following requirements must be met:

- The iPhone™ **must** be compatible with Apple CarPlay™.
- Voice control (Siri™) **must** be active on the iPhone™.
- Apple CarPlay™ **must** be active without limitations in the iPhone™ settings.

- If this is not possible via Apple CarPlay™ Wireless, the iPhone™ **must** be connected to the infotainment system via a USB connection. Only USB connections with data transmission are suitable for the use of Apple CarPlay™.
- The USB cable used **must** be an original Apple™ cable.

Apple CarPlay™ Wireless: Bluetooth® and Wi-Fi must also be activated on the iPhone™.

Establish connection

When you first connect an iPhone™, follow the instructions on the infotainment system display and on the iPhone™.

The requirements must be met to use Apple CarPlay™.

Launch Apple CarPlay™:

- Press **HOME > Full Link** to access the Full Link main menu.
- Press Apple CarPlay™ to establish a connection with the iPhone™.

Disconnecting

- In Apple CarPlay™ mode, press the **SEAT** icon to access the Full Link main menu.
- Press **X** to interrupt the active connection.

The representation of function buttons on the screen may vary.

Special characteristics

During an active Apple CarPlay™ connection, the following characteristics are applicable:

- Bluetooth® connections between the iPhone™ and the infotainment system are **not** possible.
- If there is an active Bluetooth® connection, it is automatically interrupted.
- It is **not** possible to use the built-in navigation system and the Apple CarPlay™ navigation system at the same time. The last route started interrupts the one that was previously active.
- Depending on the infotainment system you use, on the instrument cluster display you can view data from the Telephone mode.
- Depending on the infotainment system you use, on the instrument cluster display you can view data from the Media mode.
- Only navigation instructions from compatible apps are displayed on the instrument cluster's screen.
- With the multifunction steering wheel you can accept or reject incoming calls, as well as end an ongoing telephone conversation.

Voice control

- Press **Ⓜ** briefly to start voice control using the infotainment system.
- Press and hold this button to start voice control (Siri™) of the connected iPhone™.



Note

- **The availability of technologies depends on the country and may vary.**
- **You will find information about technical requirements, compatible iPhones, certified applications and their availability on the SEAT (www.seat.com) and Apple CarPlay™ websites, or at SEAT dealerships.**

Android Auto™

Requirements for Android Auto™

In order to use Android Auto™, the following requirements must be met:

- The mobile phone device, called smartphone from here on, **must** be compatible with Android Auto™.
- The smartphone **must** have an Android Auto™ application installed.
- If this is not possible via Android Auto™ Wireless, the smartphone must be connected to the infotainment system via a USB connection with data transmission.
- The USB cable used **must** be an original cable provided by the smartphone manufacturer.

Android Auto™ Wireless: The smartphone's Bluetooth® and Wi-Fi signal also have to be on.

Establish connection

When you first connect a smartphone, follow the instructions on the infotainment system display and on the smartphone.

The requirements must be met to use Android Auto™.

Launch Android Auto™:

- Press **HOME > Full Link** to access the Full Link main menu.
- Press Android Auto™ to establish a connection with the smartphone.

Disconnecting

- In Android Auto™ mode, press the **SEAT** icon to access the Full Link main menu.
- Press **X** to interrupt the active connection.

Special characteristics

During an active Android Auto™ connection, the following characteristics are applicable:

- An active Android Auto™ device can be connected at the same time via Bluetooth® (HFP profile) with the infotainment system.
- It is possible to use the phone's functions through Android Auto™. If the Android Auto™ device is connected at the same time via Bluetooth® with the infotainment system, the telephone function of the infotainment can also be used.

- An active Android Auto™ device **cannot** be used as a media device in the **Media** main menu.
- It is **not** possible to use the built-in navigation system and the Android Auto™ navigation system at the same time. The last route started interrupts the one that was previously active.
- Telephone and Media data can be displayed on the instrument cluster display.
- Only navigation instructions from compatible apps are displayed on the instrument cluster's screen.
- With the multifunction steering wheel you can accept or reject incoming calls, as well as end an ongoing telephone conversation.

Voice control

- Press **Ⓜ** briefly to start voice control using the infotainment system.
- Press and hold this button to start voice control (Google Assistant) on the connected smartphone.

i Note

- **The availability of technologies depends on the country and may vary.**
- **You will find information about technical requirements, compatible mobile phone devices, certified applications and their availability on the SEAT (www.seat.com) and Android Auto™ websites, or at SEAT dealerships.**

Wired and wireless connections

USB connection



Fig. 135 Centre console: USB input.

Depending on the equipment and the country, the vehicle may have different types of USB connections.

The USB port can be found in the storage compartment area of the front centre console **>>> Fig. 135.**

i Note

Before switching the ignition on or off, unplug the appliances from the USB ports to protect them from any damage caused by fluctuations in voltage.

Infotainment system


First steps

Introduction

Infotainment functions and settings depend on the country and equipment.

Before first use

Before the first use, bear in mind the following points, to take full advantage of the functions and settings offered:

- Observe the basic safety warnings
»» page 195.
- Restore infotainment to factory settings
»» .
- Search and store favourite radio stations on the preset buttons so you can tune them quickly.
- Use only suitable audio sources and data media.
- Pair a mobile phone to use phone management through the Infotainment system.
- Use current maps for navigation.
- Register in SEAT CONNECT to run the corresponding services.

Current documentation attached

For using infotainment and its components, take into account, together with this instruction manual, the following documentation:

- Supplements to your vehicle's on-board documentation.
- Instruction Manual of the mobile phone device or audio sources.
- Operating instructions for data media and external players.
- Manuals for the Infotainment accessories subsequently installed or used additionally.
- Description of services when running SEAT CONNECT services.

WARNING

Restoring to factory settings deletes the vehicle settings and personal data. *Online services can no longer be used in this vehicle and can only be used again after they have been re-activated. If there is a primary user connected to the vehicle, he/she will also be removed and informed by e-mail. If mobile keys have been created, they will be permanently deleted.*

Safety instructions

Some function areas may include links to third-party websites. SEAT, S.A. is not the owner of the third-party websites accessible through the links, and assumes no liability for their content.

Some function areas may include outside information from third-party providers. SEAT, S.A. is not responsible for such information being correct, up-to-date or complete, or for ensuring it does not infringe the rights of third parties.

Radio stations and owners of data media and audio sources are responsible for the information they transmit.

Bear in mind that car parks, tunnels, tall buildings, mountains or the operation of other electrical devices, such as chargers, can also interfere with the reception of the radio signal.

Foils or adhesives with metallic layers on the antenna and on the window panes can interfere with radio reception.

WARNING

The infotainment central computer is interconnected with the control units mounted on the vehicle. Therefore, there is a serious danger of accident and injury if the central computer is repaired or disassembled and reassembled incorrectly.

- Never replace the central computer with another one that is used, recycled or from another vehicle at the end of its useful life.
- The central computer should only be repaired or disassembled and reassembled at specialised workshops. SEAT recommends visiting a SEAT dealership for this.

WARNING

Any distraction affecting the driver in any way can lead to an accident and cause injuries. Reading the information on the screen and managing the infotainment system can distract your attention from traffic and cause an accident.

- Always drive with attention to traffic and in a responsible manner.

WARNING

Connecting, inserting or removing an audio source or data media while driving can distract your attention from the traffic and cause an accident.

WARNING

Select volume settings that allow you to easily hear signals from outside the vehicle at all times (e.g. emergency services sirens).

- Hearing may be impaired if using too high a volume setting, even if only for short periods of time.

WARNING

The following circumstances may result in an emergency call, phone call or data transmission not being made or being interrupted:

- When in areas with zero or insufficient mobile telephony or GPS signal. Also in tunnels, confined areas between very tall buildings, garages, underpasses, mountains and valleys.
- When in areas with sufficient mobile phone or GPS signal, the telephony network of the telecommunications provider has interference or is not available.
- When the vehicle components necessary to make emergency calls, phone calls and to transmit data are damaged, do not work or do not have sufficient electrical power.
- When the battery of the mobile phone device is discharged or its charge level is insufficient.

WARNING

In some countries and some telephone networks it is only possible to make an emergency call, if a mobile telephone device is connected to the telephone interface of the vehicle, inside which there is an “unlocked” SIM card with sufficient balance to make calls and with sufficient network signal coverage.

WARNING

Read and observe the operating instructions provided by the manufacturer in question when using mobile phone devices, data media, external devices, external audio and multimedia sources.

WARNING

Changing or connecting an audio or multimedia source may cause sudden changes in the volume.

- Lower the volume before connecting or switching to audio or multimedia sources.

WARNING

If mobile phone and radiocommunication devices are used without connection to an external antenna, the maximum electromagnetic radiation levels inside the vehicle might be surpassed, thus posing a risk to the health of the driver and passengers. This is also the case if the external antenna has not been correctly installed.

- Keep a distance of at least 20 centimetres between the antennas of the mobile phone device and an active medical device, such as a pacemaker, as mobile phones might alter the functioning of these devices.
- Do not carry a switched-on mobile phone too close or directly on top of an active medical device, for instance in a chest pocket.

- Immediately turn off the mobile phone if you suspect it is causing interferences in an active medical device or any other medical device.

WARNING

Mobile phones, external devices and accessories that are loose or not properly secured could move around the vehicle interior during a sudden driving or braking manoeuvre or an accident and cause damage or injury.

- Place mobile phone devices, external devices and their accessories outside the airbag deployment areas or store them securely.
- Position the connection cables of the audio sources and external devices so that they do not interfere with the driver.

WARNING

The centre armrest may obstruct the driver's arm movements, which could cause an accident and severe injuries.

- Keep the storage compartments of the centre armrest closed at all times while the vehicle is in motion.

WARNING

If the light conditions are not good and the screen is damaged or dirty, the indications and information displayed on the screen may not be read or be read incorrectly.

- The indications and information displayed on the screen should never induce you to take any risk that compromises safety. The screen is not a replacement for driver awareness.

WARNING

Radio stations can transmit disaster or hazard announcements. The following conditions prevent such notices from being received or issued:

- When in areas with zero or insufficient radio signal. Also in tunnels, confined areas between very tall buildings, garages, underpasses, mountains and valleys.
- When the frequency bands of the radio station have interference or are not available in areas with sufficient radio signal reception.
- When the speakers and the vehicle components necessary for radio reception are damaged, do not work or do not have sufficient electrical power.

WARNING

Switch off mobile phone devices in areas with a risk of explosion!

WARNING

The driving recommendations and traffic indications shown on the navigation system may differ from the current traffic situation.

- Road signs, signalling systems, traffic regulations and local circumstances prevail over driving recommendations and navigation system indications.
- Adapt your speed and driving style to suit visibility, weather, road and traffic conditions.
- Certain circumstances can significantly lengthen both the initially planned duration of the trip and the route to the destination, or even temporarily prevent navigation to it, for example, if a road is closed to traffic.

NOTICE

In areas where special regulations apply or the use of mobile phones is forbidden, the mobile device in question must be switched off at all times. The radiation produced by a mobile phone device when switched on may interfere with sensitive technical and medical equipment, possibly resulting in malfunction or damage to the equipment.

NOTICE

If the playback volume is excessive or distorted, the speakers may be damaged.

Overview and controls

Connect System

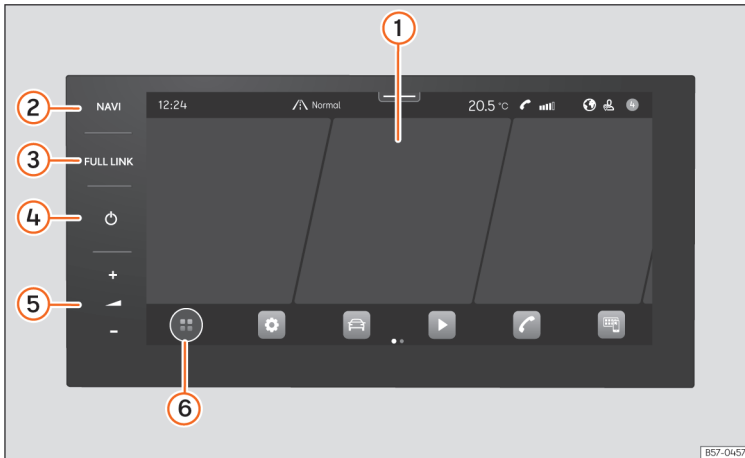


Fig. 136 Overview: control unit

- ① Touch screen. The infotainment functions can be used through the screen.
- ② Navigation menu access
- ③ Access the Full Link menu
- ④ Turn the infotainment on/off
- ⑤ Turn volume up/down
- ⑥ Main menu in tile mode.

Media System

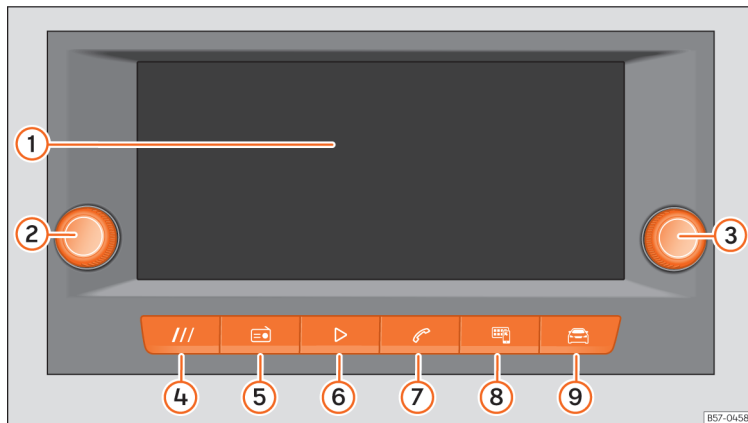


Fig. 137 Overview: control unit and indication in the 8.25-inch version

- ① Touch screen. The infotainment functions can be used through the screen.
- ② Rotary push button (to adjust the volume and to switch the infotainment on/off)
- ③ Rotary push button (to search and select)
- ④ HOME button (to open the start page)
- ⑤ Radio >>> page 207
- ⑥ Multimedia >>> page 211
- ⑦ Telephone >>> page 221
- ⑧ Full Link >>> page 191
- ⑨ Vehicle >>> page 35

General instructions for use

Operating indications

- The infotainment system needs a few seconds to start up completely and during that time it does not react to inputs. Only the image of the rear view camera system can be displayed during system start-up.
- The display of all indications and the execution of functions only takes place once the infotainment system has finished luggage compartmenting. The duration of the system luggage compartmenting depends on the number of infotainment functions and may take longer than normal in the event of very high or very low temperatures.
- When using the infotainment system and corresponding accessories, e.g., headphones, bear in mind country-specific regulations and legal provisions.
- Some functions of the infotainment system require an active SEAT CONNECT user account and an Internet connection for the vehicle. Data transmission must not be limited for functions to be performed.
- To use the infotainment system, simply lightly press a button or touch the screen.
- For the correct operation of the infotainment system it is important that it is switched on and that, if necessary, the time and date of the vehicle are set correctly.
- If a function button is missing on the screen, it is not a device defect, but corresponds to the specific equipment of the country or version.
- Some infotainment functions can only be selected when the vehicle is at a standstill. In some countries, the selector lever must also be in the parking position **P** or in neutral position **N**. It is not a malfunction, but is due to compliance with legal provisions.
- Restrictions on the use of devices using Bluetooth® technology may apply in some countries. For further information, contact the local authorities.
- If you disconnect the 12-volt battery, turn on the ignition before restarting the infotainment system.
- If the setup is changed, this may change the display on the screen and in some cases, the infotainment system may behave in a manner different to that described in this instruction manual.
- In some countries, the infotainment system automatically shuts off when the engine is switched off and the vehicle's 12-volt battery charge level is low.
- Ensure that any repairs or modifications that need to be carried out on the infotainment system are carried out by a specialised workshop. SEAT recommends visiting a SEAT dealership for this.
- Using a mobile phone device inside the vehicle may cause noise in the speakers.
- On vehicles with park assist, the audio source volume is automatically lowered when reverse gear is selected, as well as when the doors are opened. The volume reduction can be adjusted.
- Information about the included software and the license conditions can be found in **Settings > Copyright**.
- When selling or lending the vehicle, make sure that all saved data, files and settings have been deleted and, if necessary, external audio sources and data media have been removed.

Note

You can find more information and tips for using the infotainment system in the **Help menu**.

HOME screen

In the control and display unit you can set up the views and representation on the home screen or use the factory setting templates.












If an icon is missing on the screen, it is not a device defect, but corresponds to the specific equipment of the country or version.

The following menus can be included as an icon on the home screen:

Main menus on the home screen

 Navigation »»» page 214

 Radio »»» page 207, Media »»» page 211

-  Telephone >>> page 221
-  Full Link >>> page 191
-  Settings >>> page 202
-  Vehicle and Driving data >>> page 36
-  Assistance systems >>> page 35
-  Air conditioning >>> page 102
-  Sound
-  Users
-  Shop
-  Legal
-  Help

Managing the infotainment system

Execute the functions and settings with the infotainment controls.

Depending on the equipment, the infotainment system has different controls:

- Touch screen.
- Touch zones outside the screen, for example, Volume (+ -).
- Function buttons, for example, **RADIO** or **MEDIA**.

Open the Quick Guide

More information and operating tips can be found in the Infotainment Quick Guide.

- Press **HOME** >  **Help**.

Connecting and disconnecting the infotainment system

The infotainment system turns on when the ignition is switched on, unless it has been manually turned off beforehand.

The infotainment system starts-up with the last set volume, provided that this does not exceed the preset maximum start-up volume.

The infotainment system automatically turns off when the driver's door is opened, provided the ignition has been switched off beforehand.

Moving objects and adjusting volume

Move objects on the screen to adapt settings, for example, with scrollable buttons or to move the areas of a menu.

Depending on the equipment, menus and displays can be customised.

Zooming into and out of images or map sizes

Tip: use your thumb and index finger.

- Press on the map with both fingers at the same time and leave them on the screen.
- To enlarge views, slowly separate one finger from the other. To reduce views, slowly bring one finger towards the other.

Note

If you turn on the infotainment system manually with the ignition off, it will automatically turn off after about 30 minutes.

Note

As with most state-of-the-art computer and electronic equipment, in certain cases the system may need to be rebooted to make sure that it operates correctly. To do this, if appropriate, press and hold the On/Off button of the infotainment system [>>> page 198] for approx. 15 seconds until the SEAT logo appears on the display.

Customising the infotainment system

Customise the menus and infotainment views to quickly access your favourite or most frequently used functions.

The main menu contains function buttons for accessing all of the Infotainment apps.

Customise shortcuts

At the bottom of the screen you will find shortcuts to customisable system functions. Use the settings to delete or replace them, or change their order.

- Press and hold one of the icons (or press + of an empty position) to display an additional window.
- Select one of the icons from the apps bar.
- Press **Delete Favourite** to delete an icon.
- Click on an icon in the additional window to replace the value.
- Hold your finger on one of the icons and drag it to the desired position.
- To close the edit mode, press **Finish** in the additional window, or press Ⓞ.

Settings (system and sound)

The selection of possible settings varies depending on the country, the equipment in question and the equipment of the vehicle.

Modifying settings

The meaning of the following symbols are valid for all system and sound settings.

All changes are automatically applied when the menus are closed.



The setting is selected and activated or connected.

<input type="checkbox"/> / <input type="radio"/>	The setting is not selected, disabled or disconnected.
▼	To open a drop-down list.
+	To increase a setting value.
−	To reduce a setting value.
<	To go back step by step.
>	To go forward step by step.
⦿	To change a setting value with the scrollable button without adjusting.

Sound settings

- Access the sound settings: **HOME > 🔊**.

In the sound settings there may be the following functions, information and setting options:

- Equaliser.
- Position.
- Settings.

System settings

- Access the system settings: **HOME > ⚙️**.

In the system settings there may be the following functions, information and setting options:

- Screen.
- Time and date.
- Language.
- Additional keypad languages.

- Units.
- Voice control.
- Wi-Fi.
- Data connection.
- Manage mobile devices.
- Reset factory settings.
- System information.
- Copyright.
- Configuration wizard.

Adjust the volume of external audio sources

If you need to increase the playback volume for the external audio source, first lower the volume on the infotainment system.

If the sound from the connected audio source is **very low**, increase the **output volume** on the external audio source. If this is not enough, change the **input volume** to **medium** or **high**.

If the sound from the connected external audio source is **too loud or distorted**, lower the **output volume** on the external audio source. If this is not enough, change the **input volume** to **medium** or **low**.

Clean the screen

Remove persistent dirt carefully and without using aggressive cleaning products. To clean the screen we recommend that:

- The infotainment system is switched off.
- Use a clean, soft cloth dampened with water
»» page 305.
- In case of persistent dirt: soften the dirt by moistening with a little water. Then carefully remove with a clean, soft cloth.

! NOTICE

Cleaning the screen with inappropriate cleaning products or when dry, may damage it.

- When cleaning, only press lightly.
- Do not use cleaning products that are aggressive or contain solvents. Such products may damage the equipment and darken the screen.

Trademarks, licenses and copyrights

Registered trademarks and licenses

Certain terms in this manual bear the symbol ® or ™. These symbols indicate that they are trademarks or registered trademarks. The ab-

sence of this symbol, however, does not necessarily mean that the term in question can be used freely.

Other product names are registered trademarks of the respective rights holders.

- Manufactured under license from Dolby Laboratories. Dolby and the double-D symbol are trademarks of Dolby Laboratories.
- Manufactured under license from Dolby Laboratories. Dolby, Pro Logic and the double-D symbol are trademarks of Dolby Laboratories.
- Android Auto™ is a trademark of Google Inc.
- Apple CarPlay™ is a trademark of Apple Inc.
- Bluetooth® is a registered trademark of Bluetooth® SIG, Inc.
- iPod®, iPad®, and iPhone® are trademarks of Apple Inc.
- Windows® is a registered trademark of Microsoft Corporation, Redmond, USA.
- MPEG-4 HE-AAC audio coding technology and patents are licensed by Fraunhofer IIS.
- This product is protected by certain Microsoft Corporation industrial and intellectual property rights. The use or commercialization of technology of this type outside the configuration of this product, without a licence from Microsoft or an authorised Microsoft branch is prohibited.

Copyright

As a general rule, audio and video files stored on data media and audio sources are subject to intellectual property protection in accordance with the national and international provisions applicable in each case. Please bear in mind all legal provisions!

Technical data

Radio with integrated hardware (8.25 ") ¹⁾

The factory-mounted radio in the vehicle with integrated hardware includes country-specific components and software for connectivity and for the execution of vehicle, comfort and infotainment functions.

The corresponding indications are displayed on the radio screen and partly on the instrument cluster.

- Capacitive colour screen:
 - 8.25 inch version, TFT, WVGA: 1082 x 480 pixels.
- Touch operation via the device screen, rotary push-button, menu button and buttons on the multifunction steering wheel.

¹⁾ Equipment name: Media System.

Central computer with control and display unit¹⁾

The factory-mounted central computer in the vehicle includes country-specific components and software for connectivity and for the execution of vehicle, comfort and infotainment functions.

The corresponding indications are shown on the control and display unit screen and partly on the instrument cluster.

- Capacitive colour screen
- Using the equipment with:
 - Touch zones. Touch operation.
 - Buttons on the multifunction steering wheel.
 - Proximity sensors and gesture control.

HOME >  Settings > Display.

Vehicle and comfort functions

- Assistants system settings.
- Heating and air conditioning settings.
- Lights and visibility function settings.
- Vehicle comfort settings.
- Parking and manoeuvring settings.

Note

Setting navigation routes and other functions requiring the vehicle's location will be more efficient if you activate the privacy settings to share your location >>> page 189 and if you give your consent in the App on your mobile device for it to share your location data.

Sound system (basic equipment):

The factory-fitted entertainment system is equipped as follows:

- Speakers in different locations and with different power levels (watts).
- Internal amplifier depending on the system:
 - 4 speakers: 2 x 20 W
 - 6 speakers: 4 x 20 W

Setting options:

- Equaliser, depending on the system:
 - 4 speakers: treble, mid and bass.
 - 6 speakers: 5 frequency bands.
- Sound distribution, depending on the system:
 - 4 speakers: Balance (left / right).
 - 6 speakers: Balance + Fader (left / right / front / rear).
- Sound optimisation by zones (valid for the 6-speaker system):
 - Manual (Driver and All).

Optional sound system

The factory-fitted entertainment system is equipped as follows:

- 7 speakers in different locations and with different power levels (watts).
- External amplifier (Ethernet or CAN depending on the 300W infotainment system), which processes the audible signals sent by the central computer.
- Excitation of speaker channels through class AB final stages.
- Audio signal processing in digital internal signal processor (DSP).
- Independent subwoofer in the luggage compartment.

Setting options:

- Equaliser, depending on the system:
 - User equaliser: 5 bands.
 - Sound distribution: Balance + Fader (left / right / front / rear).
- Sound optimisation by zones:
 - Manual (Driver, Front and All).
- Subwoofer volume

Wi-Fi

- Wi-Fi conforming to IEEE 802.11 b/g/n.
- 2.4 GHz and 5 GHz transmission (depending on the country).

¹⁾ Equipment name: Connect System

- Apple Car Play™ and Android Auto™ over Wi-Fi.
- Simultaneous connection of up to 8 Wi-Fi devices.
- **Media System:**
 - 5GHz access point for Full Link Wireless only.
- **Connect System:**
 - Access point.
 - Tethering.
 - Pairing process simplified using WPS or QR code.

Bluetooth® profiles

There can be a maximum of two mobile devices connected to the Bluetooth® hands-free and a third device connected to the Bluetooth® as a music player.

When a mobile phone is connected to the telephone management system, a data exchange takes place via one of the Bluetooth® profiles.

- **Hands-free telephone profile (HFP):** the HFP can be used to manage calls through the infotainment system.
- **Audio profile (A2DP):** This profile allows audio to be transmitted with stereo quality. Other profiles may need to be connected for managing and controlling playback.
- **Phone book access profile (PBAP):** Allows phone book contents to be downloaded from the mobile telephone.


- **Messaging profile (MAP):** It allows short messages (SMS) and emails to be downloaded and synchronised.

Voice control

Introduction

Voice control works both *online* and *offline*, taking into account the aspects indicated in the section **"Languages available depending on the market"**.

In *offline* mode the catalogue of voice commands is limited. For a better user experience, it is advisable to use the *online* mode by activating the *online* voice assistant via the My SEAT App, which provides the user with a wider range of voice commands.

Voice control understands questions and expressions without having to learn commands. Commands can be formulated freely and can be colloquial. For better system operation, it is recommended to always include a verb in the voice command. Command proposals can be found in the infotainment system, for example in the  **Help > Voice control** menu.

Loud noises inside or outside the vehicle can cause malfunctions, as well as confusing phrases and answers.

Languages available depending on the market

- German, American English, British English, French, Italian, Spanish, Czech, Dutch, Polish, Portuguese, Swedish, Danish and Norwegian. These languages have advanced functions such as Online Commands, natural interaction, etc.

The other languages of the infotainment system **do not** offer natural interaction.

Requirements

- Voice control with the corresponding infotainment installed in the vehicle.
- *Online:* current SEAT CONNECT Plus contract active.

Note

- **Voice control only recognises commands in the language that is set in the infotainment system.**
- **Test the voice control with the vehicle stopped before starting to move to familiarise yourself with its operation.**
- **Online voice search will be faster and more reliable if the "Use location" privacy setting is selected.**
- **Voice control can only control functions that are available as part of the vehicle's equipment.**

Activation word and commands

Voice control wake words

Voice control starts when the infotainment recognises the wake word.

If you have connected the voice control via the wake word, the connected infotainment replies with "What would you like to do?".

- **OR:** after the activation word, say the desired command, for example: "Hola Hola" and then "Heating".

The system scans the words spoken in the vehicle after the activation word and displays them on the screen.

Activate and deactivate the activation word

- Press **HOME** > **Settings** > **Voice control** > **Activate / deactivate wake word**.

Activation word:

Hola Hola

Commands

To help the voice control recognise commands reliably:


- Pronounce clearly. Confusing commands are not recognised. Speak in a normal tone of voice. Speak a little louder if you are driving at high speed.
- Avoid outside noises. Open windows and doors can interfere with voice control.

- Avoid other background noises, such as conversations in the vehicle. Do not direct the air flow from the outlets towards the microphone or the interior lining of the roof.
- Do not make long pauses.



Voice control is active and recognises the spoken words.

Note


• **When the activation word is disconnected, the infotainment system cannot be activated by means of the activation word. Voice control is still available via the  button on the multifunction steering wheel. You can deactivate the activation word in HOME > Settings > Voice control > Activate/ deactivate the activation word.**

- **Availability depends on country and equipment.**

Start and stop voice control

Depending on the equipment, you can start voice control in different ways.


Start voice control

- *Voice control activation:* say the word that activates voice control.
- *Multifunction steering wheel:* press the voice control button .

In some cases you can also start voice control of the connected mobile phone device, by pressing and holding the voice control button.

Manually ending voice control

Voice control can be cancelled with the **Cancel** command.

- *Multifunction steering wheel:* tap the voice control button  once to cancel the function.

Voice control ends automatically if you use infotainment functions, if the park assist system is turned on or if there is an incoming call.

Radio mode

Introduction

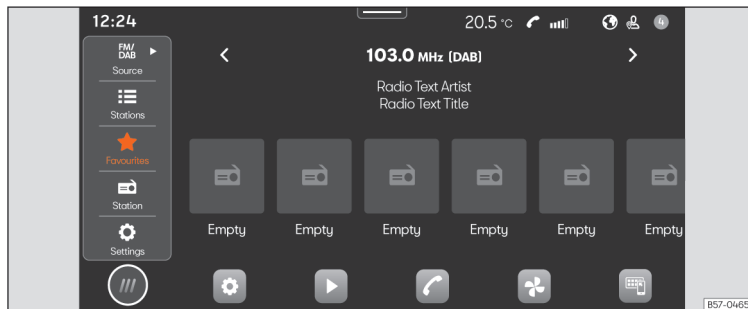


Fig. 138 Schematic representation: Radio view.

In Radio mode you can tune in the available radio stations in different frequency bands and save your favourites on the preset buttons to access them quickly.

The types of reception and frequency bands available depend on the equipment and the country. In certain countries, frequency bands may stop broadcasting or may no longer be available.

Access the RADIO menu

- Press **HOME** > >>> **Fig. 138**.

Access the settings

- Press **HOME** > > .

Online functions in Radio mode

Online functions in Radio mode are only available under the following conditions:

- SEAT CONNECT or SEAT CONNECT Plus equipment.
- You have an active SEAT CONNECT user account.
- The vehicle is assigned to your user account.
- You have a corresponding data plan purchased from the webshop of SEAT's official data supplier, or you have a volume of data for your own mobile device via the Wi-Fi hotspot.

Note

- **Radio stations are responsible for the content of the information they transmit. Electrical equipment connected to the vehicle may also cause interference in radio signal reception and noise in the loudspeakers.**
- **Foil or metal-coated stickers attached to the windows may affect reception on vehicles with a window aerial.**

Radio equipment and symbols

The functions, as well as the types of reception and frequency bands available depend on the equipment and the country.

- AM tuner.
- Dual FM receiver (diversity antenna).
- Summarised FM station list.
- Merger of DAB and FM stations into one list.
- Fusion of all stations stored in preset buttons into one list. Maximum 36 favourite stations.
- Station logos.
- DAB presentation (slideshow). Images that are emitted sequentially.
- Internet radio.

Universal symbols in Radio mode


AM To select the desired AM frequency band.


FM/DAB To select the desired FM/DAB frequency band.

Internet radio To select the type of Internet radio reception.

TP Next to the name of the station, monitoring of active traffic information stations (TP).

Symbols on the FM/DAB frequency band


 To display the frequency band for manual selection of the FM frequency. Only the FM band should be selected in the Radio context.

 DAB not available.

 DAB stations support presentations (slide-show).

Symbols on the AM frequency band

 Manually updating the station list.


 To display the frequency band for manual selection of the AM frequency.


Menus in Internet radio mode


 Show station selection.


 Open text search.


 Show the last online radio stations heard.

 Show the 100 most played radio stations and podcasts.

 Show available online radio podcasts.

 Show online radio stations, grouped by country.

 Show online radio stations by the desired language.

 Show online radio stations whose programme belongs to the desired musical genre.

Selecting, tuning and saving a station

Select the frequency band

Before selecting a station you have to select a frequency band or a type of reception. Different stations are available depending on the frequency band selected or the type of reception.

The types of reception and frequency bands available depend on the equipment and the country.

- Select the frequency band or type of reception: AM, FM/DAB, FM (for devices that do not have DAB), Internet radio.

Search and select a station

You can select radio stations in different ways. The options vary depending on the frequency band and the type of reception.

Select via the frequency band (AM and FM)

1. Activate the frequency band.
2. Click on the cursor, scroll through the frequency band and release it when you reach the frequency band you want.

OR: press on a point on the frequency band. The cursor will automatically jump to the corresponding frequency.

The station of the set frequency is tuned.

Select from the station list (AM and FM/DAB)

The station list shows the stations that are currently tunable. In the AM frequency band, you may have to update the station list if you are no longer in the area where you last accessed the station list. In the FM/DAB frequency band, the station list is automatically updated.

1. Open the station list
2. Press the station you want.

The selected station is tuned. In the case of FM/DAB and if the station is available, the best quality reception is automatically selected.

Search and filter stations (Internet radio)

In Online Radio mode, stations can be filtered by categories and can be searched by text.

1. Open the station list.
2. Select the category by which the stations are to be filtered.

OR: press Q to start the text search. The input field is displayed.

3. Enter the name of the station you want. The list of the stations found is updated while entering the text.
4. Press the station you want.

The selected station is tuned.

Save stations on the preset keys

You can store up to 36 stations of different frequency bands and reception types as favourites using the preset buttons.

1. Tune the station you want.
2. Access the preset buttons.
3. Press the preset button and hold it down until the station is stored.

OR: press the station on the station list and hold it down. The preset buttons are displayed.

4. Press the preset button.

The station is stored in the selected preset button.

If a station was already stored in the preset button, it is overwritten with the new station.

Special functions in Radio mode**Traffic information (TP)**

The TP function monitors the announcements of a station with traffic information and automatically reproduces them in the Radio mode or in the multimedia playback that is active. To do this, you have to be able to tune into a station with traffic information.


Some stations without their own traffic information support the TP function by broadcasting traffic information from other stations (EON).

In the FM frequency band or in the Multimedia mode, a station with traffic information in the background is automatically tuned while it is possible to tune into a station with traffic information.

If no station with traffic information can be tuned in, the device automatically searches for stations with tunable traffic information.

Stations with traffic information are not available in all countries.

Activating and deactivating the TP function

- In Radio mode or Multimedia mode, press  > **Traffic programme (TP)**.

Presentations (SlideShow) in DAB

The slideshow function (SLS) is a feature of digital radio (DAB) stations, allowing a slideshow of images, e.g. the station's logo, to the user.

Activating and deactivating the SLS function

It is possible to deactivate the slideshow function on DAB radio stations:

- In the Radio Menu click on the area where the station information is located, either in the name or on the additional information (author or information text).

OR: tap **Radio Settings > Display DAB picture gallery and additional information** (activate/deactivate).

Online radio.

Online radio is a type of reception for Internet radio stations and podcasts that are independent of AM, FM and DAB. Thanks to Internet transmission, reception is not limited to the region.

Online radio is only available through the Internet connection of the active infotainment system. The use of online radio can generate expenses due to the transmission of data from the Internet.

- In Online radio mode, press and set the audio quality to high or low to tune the online radio.



Station logos

In the case of some frequency bands, station logos may already be pre-installed in the infotainment system.

If in the FM/DAB frequency band settings the **automatic selection of station logos** is activated, station logos are automatically assigned to the stations.

In the Online radio mode, the infotainment system accesses the station logos of the online database and automatically assigns them to the stations.

Assign station logos manually

1. In FM/DAB mode, press **Station logos**.
2. Press on the  icon and then select the station to which a station logo is to be assigned.
3. Select the station logo. If desired, repeat the same process with other stations.
4. **OR:** via the menu  > **Station logos**.

Additional DAB warnings

The DAB announcement function monitors possible notifications from DAB radio stations and plays them automatically in Radio mode.

Activate and deactivate additional DAB warnings:

- **Menu > Additional DAB announcements** (Activate/deactivate).

Radio text

The radio text function provides information related to the selected radio station.

Activate and deactivate Radio text:

- **Menu > Radio Text** (Activate/deactivate).

Media Mode

Introduction

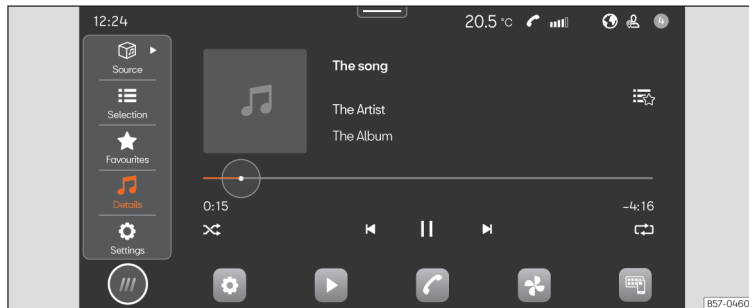


Fig. 139 Schematic representation: Media view

In Media mode you can play multimedia files from data media through the infotainment system.

Depending on the equipment, the following data media can be used:

- USB storage support (for example, a USB stick, a mobile phone connected via USB).
- Bluetooth® device (for example, a mobile phone or a tablet).

Depending on the equipment, the following types of multimedia files can be played:

- Audio files.
- Video files (depends on the system).

Access the MEDIA menu

- Press **HOME** > ► >>> **Fig. 139**.

Access the settings

- Press **HOME** > ► > ⚙️.

Data media limitations and indications

Data media may not work if they have been exposed to high temperatures or have been damaged. Please bear in mind the manufacturer's indications.

Quality differences between data media produced by different manufacturers can cause multimedia playback malfunctions.

Incorrect data media configuration may make it unreadable.

Playlists only specify a playback order and refer to the storage location of the multimedia files within the folder structure. No multimedia files are saved in a playlist. To play a playlist, multimedia files have to be found in the storage places of the data media to which the playlist refers.

i Note

SEAT assumes no liability for any deterioration or loss of files on data storage devices.

Equipment features and media symbols

Audio, multimedia and connectivity:

- Media playback and control via Bluetooth®.
- Audio playback in these formats: AAC, APE, ALAC, FLAC, MP2, MP3, MP4, Vorbis, OPUS, WMA, WAV.
- Video playback in these formats:
 - MPEG-1 and MPEG-2 (.mpg, .mpeg, .mkv, .avi).
 - ISO MPEG-4 ASP; Xvid (.mp4, .m4v, .mov, .mkv, .avi).
 - ISO MPEG-4 AVC / H.264 (.mp4, .m4v, .mov, .mkv, .avi).
 - Windows Media Video 9 (.wmv, .asf, .mkv, .avi).
- Playlists on any type of device.
- Multimedia search.

Universal symbols in Media mode

- ▶ Start playback.
- || Pause playback.
- ◀ Change to the previous track.
- ▶ Change to the next track.
- 🔄 Repeat the track that is playing.
- 🔄 Repeat all titles.
- 🔀 Activate the shuffle playback order.
- ★ Display a list of favourites.

- ⊕ Add a media file as favourite.
- ▼ Top right: select media source.
- ⚙ Access the settings.
- 🔍 Open the search.
- ◀ Return to the top folder of the media source.

Select and play a multimedia source

Select multimedia source

Before playing multimedia files you must first connect a multimedia source.

- Connect an external multimedia source.
- Select the connected media source to be used for playback.

Playing audio and video files

You can search and play multimedia files from an available multimedia source in different ways.

Search in the folder structure

Multimedia files can be catalogued by categories (for example, album, artist, title). In **My media** this category view is always displayed. The classic folder structure of individual USB data media is also found in **My media**.

1. Activate the folder structure.

The folder structure of the selected multimedia source is displayed. When **My media** is selected, the categories (music, videos, playlists) and connected multimedia sources are displayed first.

2. Search for the title you want in the folder structure.

OR: press **Q** to start a text search The input field is displayed.

3. Enter the name of the desired title. The list of the titles found is updated while entering the text.
4. Press the desired title.

If at the beginning of the playback your selection is in a folder of a multimedia source, the multimedia files that are in it are also added to the playback.

If a playlist is played, all available titles in the playlist are added to the playback.

5. Close your selection with **X**.

Select favourites

In favourites you can save titles, music genres, artists and albums individually for playback.

- Access favourites ★.
- Press the favourite you want.

Depending on your selection, all the titles belonging to the favourite are added to the playback.

Save favourites

Only multimedia files in **My media** of the infotainment system can be saved as favourites. You can save up to a maximum of 30 titles, albums, artists and music genres individually as favourites.

1. Start playback.
2. Access favourites.
3. Tap a favourite that is not assigned.

OR: press and hold on an existing favourite for approx. 3 seconds.

4. Select from the selection list: Title, Album, Artist, Genres, Playlist.

The selection is saved instead of the previously selected favourite. If the favourite was already assigned, the previously saved favourite is overwritten.

The selectable options in the selection list depend on the data attached to the multimedia file. If the music genre is not indicated in the music files, for example, you cannot save the music genre as favourite.

If a video file is playing, only that video can be saved as favourite.

Playing entertainment content in the infotainment system

Depending on the infotainment system, videos can be played.

Video mode

When in Video mode, a video stored on data media, in **My media** can be played on the infotainment display. In this case, the video sound is played through the vehicle's speakers.

The image is only displayed if the vehicle is stopped. When the vehicle is in motion, the infotainment screen turns off. The sound of the video can still be heard.

Navigation

Introduction

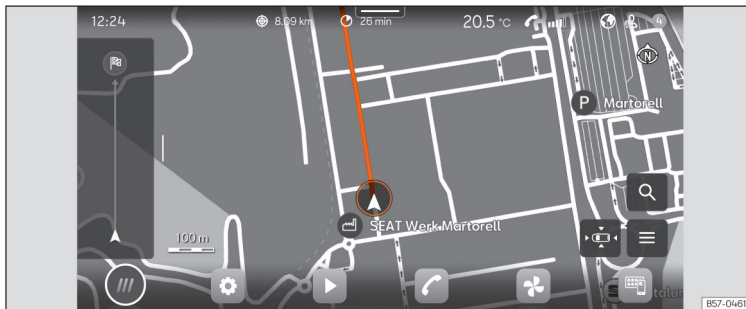


Fig. 140 Schematic representation: Navigation view.

A global satellite system determines the current position of the vehicle and the sensors mounted on the vehicle analyse the routes taken. All measured values and possible traffic events are compared with the available maps to allow optimal navigation to the destination.

Navigation announcements and graphic representations will guide you to your destination.

Navigation is managed on the screen.

Depending on the country, some functions of the infotainment system will not be available on the screen when travelling above a certain speed. It is not a malfunction, but is due to compliance with legislation.

Navigation announcements

Navigation announcements audible indications for driving relating to the current route.

The type and frequency of navigation announcements depend on the driving situation, for example, starting the guide to the destination, driving on the motorway or on a roundabout and the settings.

If the exact destination cannot be reached because, for example, it is in a non-digitised area, indications relating to the address and the distance to the destination are displayed on the screen.

During dynamic route guidance, you will receive information about reported traffic congestion on the route. An additional navigation announcement is given if the route is recalculated due to traffic congestion.

While a navigation announcement is playing, its volume can be adjusted. Subsequent navigation announcements will be played with the newly adjusted volume.

Limitations during navigation

If the infotainment system cannot receive data from GPS satellites, for example, in a tunnel or in an underground garage, navigation continues using the vehicle's sensors.

In areas that are not digitised or are only partially digitised in the infotainment's memory, the infotainment system will still attempt to provide route guidance.

In the case of missing or incomplete navigation data, it may not be possible to determine the exact position of the vehicle. This may mean that navigation is not as precise as usual.

Roads and streets are subject to constant change (e.g. new roads, road works, roads closed to traffic, changes to street names and building numbers). If the navigation data is obsolete, this may lead to errors or inaccuracies during route guidance.

Managing the navigation map

For optimal viewing, you can also manage the navigation map with additional finger movements.

Moving the map

Tip: use your index finger

- Move the map with your finger.

Zooming into or out of the view

Tip: use your index finger

- Press twice on the map and keep your finger pressed on the screen.
- To zoom out the map view, move your finger upwards. To zoom into the map view, move your finger downwards.

Change the 2D / 3D view

Tip: use your index and middle fingers

- Press on the map with both fingers at the same time and keep them pressed.
- For 2D view scroll your fingers down, for 3D view scroll your fingers up.

Rotate the map

Tip: use your thumb and index finger

- Press on the map with both fingers at the same time and keep them pressed.
- To rotate the map view, turn your fingers clockwise or anticlockwise.

Saved data

The infotainment system saves certain data, for example, frequent routes and position data, to make it easier to enter the destination and to optimise route guidance.

Delete saved data

- Press **Settings > Basic function settings > Delete** and then **Accept**.

WARNING

Select the settings, enter the destination and the modifications for navigation only with the vehicle at a standstill.

Note

- If a detour is passed during route guidance, navigation may recalculate the route.
- The quality of the navigation recommendations given by the Infotainment system depends on the navigation data available and any reported traffic congestions.
- Navigation announcements are not emitted if the sound is muted in the infotainment system.

Navigation functions and symbols

Navigation

Navigation functions depend on the equipment and country.














Functions

- Entering the destination and route calculation (offline and online.)
- Display of two navigation maps at the same time (screen and instrument cluster).
- Update of online maps.
- Predictive navigation.
- 3D urban maps.
- Online traffic information.
- Dynamic POIs (points of interest).

Symbols on the map





The buttons and indications depend on the settings and the current driving situation.

Symbols for traffic events and points of interest (POIs) are displayed on the map, for example, petrol stations, train stations or interesting stopovers, provided navigation has such data »» page 218.







-  Current position.
-  Search for destinations.
-  Destinations along the route.
-  Final destination.
-  Home address.
-  Work address.
-  Favourite destinations.
-  Additional window with more options.
-  Additional window with route options.
-  Centre the map on the current position.
-  Change view: 2D oriented to the north, or 2D oriented to the direction of travel, or 3D to the direction of travel.
-  Information about the current route guidance.
-  Map scale.

Symbols in the additional window



- To open the additional window, press .

-  Repeat the last navigation announcement.
-  Volume of navigation announcements.
-  Map lighting in Automatic, Day or Night mode.
-  Offer new guidance routes.

Other symbols

-  Entering the detailed destination for an address.
-  Search for destinations.
-  Frequent destinations.
-  Last destinations.
-  Favourite destinations.
-  Back





Symbols in the route details

-  Current position.
-  Destination of the current guidance.

POI symbols (points of interest)

POIs (points of interest) are shown on the map, provided the navigation has said data.

Click on the desired POI (point of interest) to start a route guidance »» page 217.

-  Petrol station.
-  Parking lot.
-  Tourist information offices.
-  Train station.

-  Restaurant.

Traffic information.

POIs (points of interest) are shown on the map, provided the navigation has said data »» page 218.

Click on a traffic event to open an additional window with further details »» page 219.

-  Slow traffic.
-  Traffic jam.
-  Accident.
-  Broken down vehicle.
-  Slippery surface (ice or snow).
-  Road closed to traffic.
-  Slippery road hazard.
-  Danger.
-  Road works.
-  Strong wind.
-  Reduced visibility.

Navigation data

The Infotainment system is equipped with a built-in navigation data memory. Depending on the country, the necessary navigation data may already be pre-installed.

To provide correct route guidance and make the most of the functions offered, the infotainment system should be updated on a regular basis.

Using obsolete data may lead to errors during navigation. Current routes cannot be traced or the route guidances will lead to mistaken destinations.

Ensure navigation data is updated at all times.

Online updating of navigation data

The navigation data of the regions through which you travel frequently is automatically updated in the background if the Internet connection is established and the privacy settings are valid.

- With the ignition switched on, the navigation data is updated automatically.

Manual update of navigation data

Current navigation data for large regions, for example Western Europe, can be downloaded from www.seat.com and stored on USB data devices.

- Download the navigation data to a USB data device.
- Turn on the ignition of the vehicle.
- Connect the USB data device to the infotainment system. Navigation data is automatically updated in the background.

The map version is displayed in **HOME > ⚙ > System information**.

WARNING

If you update the navigation data manually while driving, it may cause accidents with serious injuries.

- Update the navigation data only with the vehicle at a standstill.

Note

Automatic update of the navigation data is subject to the privacy settings. No update is made in incognito mode.

Start route guidance





Depending on the country and equipment, different functions are available to enter destinations.


The different functions for entering destinations are found in the navigation main menu.

Opening the Navigation main menu

- Press **HOME > **.

Select the destination and start navigation

1. Press .
2. Select the desired destination. You can choose from  **Frequent destinations**,  **Last destinations** or  **Favourite destinations**.

OR: press  and enter the address in the input screen.



OR: detailed address.

3. Press **Start**.

Frequent destinations

The destination synopsis uses recorded data to propose possible destinations.

Select the destination and start navigation:



1. Press  and then .
2. Select the desired destination. The route guidance starts automatically.

Quick start: for a quick start, press and hold the desired destination for a few seconds.

Recent destinations

Navigation saves the last destinations to make them available for a route guidance.


Select the destination and start navigation:

1. Press  and then .
2. Press the desired destination.
3. Press **Start**.



Quick start: for a quick start, press and hold the desired destination for a few seconds.

Favourite destinations

Save up to 20 destinations as favourites.

To save a destination as a favourite press  in the split screen when entering the destination.

Select the destination and start navigation:

1. Press  and then .
2. Press the desired destination.
3. Press **Start**.

Note

Enter the destination as accurately as possible. If you enter a destination incorrectly, the route guidance will not be able to start or it will guide you to an incorrect destination.


Start route guidance by selecting from the map

The navigation map includes active areas at many points that are suitable for entering the destination. To do this, press the desired position or place on the map. If there is map data at this point, you can start a route guidance.

Whether it is possible to enter the destination through the navigation map depends on the state of the data and it is not possible for all positions.

To start "offroad navigation", press an empty area without position data.

Start navigation:

1. Press .
2. Move the view on the map until the desired position can be selected. The navigation map can be used by means of additional finger movements **>>> page 214**.
3. Press the desired destination on the map.
4. Press **Route**.

Offroad navigation

"Offroad navigation" calculates routes to selected destination points using unknown data. When a destination point is outside the known roads or position data, navigation finds the route to the next point of the known road and completes the path to the next destination point with a direct connection.


Start navigation:

1. Move the view on the map until the desired position can be selected. The navigation map can be used by means of additional finger movements **>>> page 214**.
2. Press on any point on the map without position data.
3. Press **Route**.

Start route guidance using contact details

Start route guidance with the saved address data of a contact. Contacts saved without address data cannot be used for route guidance.

Start navigation:

1. Press .
2. Press on the contact you want.
3. Press **Route**.

Note

If the address details of a contact are obsolete, the route guidance will nevertheless take you to the registered address. Check that the contact address is updated.

Traffic information

The infotainment system receives detailed traffic information automatically if the Internet connection is established. This information is displayed using symbols and by highlighting the road network in colour on the map.

Traffic incidents

Traffic incidents, for example, traffic jams or congested traffic, are shown on the navigation map using symbols.

With active route guidance, traffic incidents that are on the current route are shown in the route details. Such traffic incidents can be avoided **>>> page 219, Function descriptions**.

Traffic flow indication

The navigation map shows traffic flow according to current traffic events, highlighting the road network in colour.

- **Yellow:** Slow traffic.
- **Red:** Traffic jam.

Note

Traffic information receipt is subject to the privacy settings. In maximum Privacy mode, no traffic information is received. The Tracking or Location level must be set up.

Function descriptions

Route details

The route details contain information on all incidents, for example, the starting point, stopovers, traffic events, POIs and destination, provided the navigation has such data.

If you press on an incident, an additional window opens providing more options. The available options depend on the incident and the current settings.

Open and close the route details

- To open them, press | or swipe it.
- To close them, press | or swipe it.

Edit route guidance

To edit the route guidance, move the stopovers to the destination in the TripView view.

- Hold the desired destination pressed until it is visibly highlighted.
- Move the destination to the desired position.
- Remove your finger from the screen. The route will recalculate.

Avoid traffic incidents

The details of the route show the current traffic incidents if the navigation has such data. Avoid traffic incidents by editing route details >>> page 219.

- Press on a traffic event.
- Press on **Avoid**. The route will recalculate.

Split screen

When handling navigation functions, an additional window with other options may open. Possible options depend on the function being used.

Close the additional screen

- Press on an empty area outside the additional window.
- **OR:** press X.
- **OR:** press **Accept**.

Functions in the additional window:

Show on map	Show what is selected on the map.
--------------------	-----------------------------------

Functions in the additional window:

Add stopover destination	Add a stopover to the route guidance.
Direct route	Starts direct route guidance.
Delete	Delete a stopover from the route guidance.
Avoid	Avoid traffic jam. The route will recalculate.
Stop route guidance	Ends the current route guidance.
×	Close the additional window.
☆	Add a destination to favourites.

Learn usage pattern

When the vehicle is in motion, navigation saves routes and destinations used to automatically generate destination proposals. Destinations are learned based on the time of day and the day of the week.

Navigation can propose up to 5 routes at the same time. The proposed routes may be different from the routes of the normal route guidance.


If one of the proposed destinations is selected, the guide to that destination is started.

The route guidance follows the selected route until the vehicle deviates from it. In that case, the route is recalculated and takes you back along the most direct path to the initially selected destination.

Important traffic jams are taken into account in the route guidance, and are avoided if alternative routes are available, provided navigation has such data.

You can activate and deactivate the function whenever you want.

Enable and disable learning usage pattern

The setting is in the corresponding navigation menu  > **Basic function settings**.

- To activate the function, activate **Learn usage pattern**.
- To disable the function, disable **Learn usage pattern**.
- To delete saved data, press **Delete usage pattern**.

Telephone interface

Introduction

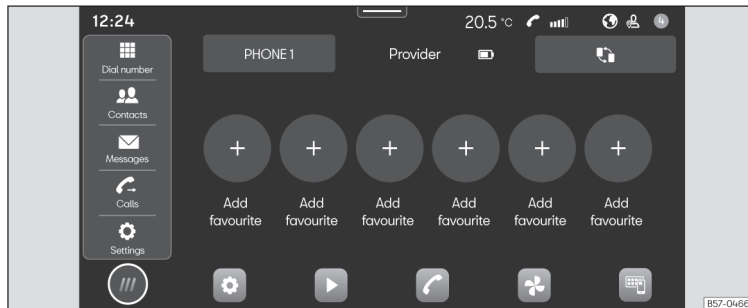


Fig. 141 Schematic representation: Phone view.

You can use the telephone interface to connect your mobile to the infotainment system and operate phone functions through it. The sound is played through the vehicle's speakers.

You can connect up to two mobile phone devices simultaneously to the infotainment system.

High speeds, poor weather or road conditions and a noisy ambience (even outside of the vehicle), as well as the quality of reception can all affect the quality of a telephone conversation in the vehicle.

Note

- **As a general rule, pairing a device (for example, a mobile phone device) is only necessary once. You can restore the device connection via Bluetooth® or Wi-Fi with the infotainment system whenever you want without having to pair the device again.**
- **The availability of some telephone functions will depend on the mobile phone connected to the infotainment system.**

Telephone interface equipment and symbols

Equipment features

- Hands-free function.
- Use up to two phones at the same time.
- Phone book with up to 5,000 contacts, depending on the infotainment system.
- SMS functions via Bluetooth®: SMS reading, SMS writing (templates included), SMS playback, message history.
- Email functions via Bluetooth®: reading email, writing email.

- Connection to wireless charging option.
- Connection to the microphone mounted on the vehicle.

Symbols in the main menu

- Contacts.
- List of incoming and outgoing calls.
- Enter telephone number.
- Text messages (SMS and emails).
- Telephone interface settings.

Symbols for calls

The symbols may be different depending on the infotainment system.

- Start a call or bringing it to the foreground.
- End or reject a call.
- Open contact list.
- Enter telephone number.
- Mute the sound of the hands-free
- Hold call.
- Continue call.
- Start conference call.
- Pass call to private mode.
- Make an emergency call.
- Voice mail.
- Ignore an incoming call.
- Switch the call to handsfree mode.

- Remove a person from the conference call.
- Get help in case of breakdown.
- Obtain information on the SEAT brand and selected additional services related to traffic and your travel.

Call list symbols

- To open the call lists, press .
- Incoming call.
- Outgoing call.
- Missed call.
- Telephone number (company).
- Telephone number (private).
- Mobile telephone number (company).
- Mobile telephone number (private).
- Fax (private).
- Fax.

Symbols for text messages

The symbols may be different depending on the infotainment system.

- To open the text messages, press .
- Activate voice control input **>>> page 205.**
- Templates for text messages.

Places with special regulations

Switch off the mobile telephone and the telephone interface in places with a risk of explosion. These places are not always clearly marked. They include, for example:

- The vicinity of chemical pipelines and tanks.
- The lower decks of boats and ferries.
- In the proximity of vehicles that run on liquefied gas (such as propane or butane).
- Places where the air is laden with chemicals or particles such as flour, dust or metal powder.
- All other places where the engine or telephone must be switched off.

WARNING

Switch off the mobile phone in areas with a risk of explosion!

Note

In areas where special regulations apply or the use of mobile phones is forbidden, it must be switched off at all times. The radiation produced by the mobile phone when switched on may interfere with sensitive technical and medical equipment, possibly resulting in malfunction or damage to the equipment.

Pairing, connecting and managing

Requirement for pairing:

- Bluetooth® is activated on the mobile phone device.
- Bluetooth® is activated on the infotainment system.
- Depending on the mobile device, it will be necessary to have the Bluetooth® menu open or activate the **Visibility** option so that the device is visible from the infotainment system.
- The vehicle must be stopped or someone must be detected in the front passenger seat to perform the pairing.

Pair a mobile phone device suitable for telephony with the infotainment system to use the telephone interface functions. When making the first connection, the mobile phone device is paired with the infotainment system. Doing so saves a user profile.

The pairing can take a few minutes. The functions available depend on the mobile phone device used and its operating system.

Pair a mobile phone device

1. Open the list of available Bluetooth® devices on the mobile phone device and select the name of the infotainment system.

2. Please note and, if necessary, confirm the messages that appear on the mobile phone device and on the infotainment system. If the pairing was successful, the phone data is saved in the user profile.
3. *Optional:* confirm the data transfer message on the mobile phone device.

Active and passive connection

To use the functions of the telephone interface, there must be at least one mobile phone device connected to the infotainment system. If there are several mobile phone devices connected to the infotainment system, you can switch between active and passive connections. To use the telephone interface with the desired mobile phone device, establish the active connection with the infotainment system.

Difference between connection types

Active The mobile phone device is paired and connected. The functions of the telephone interface are performed with the data of said mobile phone device.

Passive The mobile phone device is paired and connected. Calls can be managed but the phone book, messages or other functions will not be active.

Paired mobile phone devices are stored in the infotainment system, even if they are not currently connected.

Connect a mobile phone device

Requirement: the mobile phone device is paired with the infotainment system.


- Bluetooth® is activated on the mobile phone device.

Establish an active connection

Requirement: several mobile phone devices are connected to the infotainment system at the same time.

- Select the desired mobile phone device from the drop-down menu. All other mobile phone devices are automatically in a passive connection.

Voice control with Android Auto™ or Apple Carplay™ technologies active

The voice control functions for phones may not be available on all mobile devices, so pressing and holding the voice control activation button  on the multifunction steering wheel can be used to activate the mobile device's voice assistant.

WARNING

If you perform the pairing while driving, it could cause an accident or injury.

- Perform pairing only with the vehicle at a standstill.

Note

- While the infotainment system is in the **Known mobile phones** menu, the wireless charging function is disabled. When you exit this menu, the wireless charging function is activated again.
- When pairing some mobile phone devices, a PIN number is shown on the screen of the mobile phone device. Enter that number in the infotainment system to complete the pairing.

Basic and Comfort Telephony

Depending on the equipment, two types of telephone interface can be used:

- Basic telephone interface.
- Comfort telephone interface.

Basic telephone interface

The Basic telephone interface uses the Bluetooth® HFP profile for transmission. This interface allows the use of telephone functions through the infotainment system and playback through the vehicle's speakers.

Comfort telephone interface

Like the Basic telephone interface, the Comfort telephone interface also uses the Bluetooth® HFP profile.

The Comfort phone interface can be equipped with the wireless charging function

»» page 225.

In order to use the functions of the wireless charging function, you have to place a suitable mobile phone device correctly in the storage compartment. The mobile phone device will then connect to the vehicle antenna. This improves the reception and sound quality of calls.

Calling and sending messages

Open the telephone interface


- Press **HOME** > .

Make a call

Select a phone number to start a call. Different functions are available for selecting a phone number:

Contacts

If a contact has several registered phone numbers you have to select one.


- Press  and press a number on the list to start the call.


OR: press **Q** and enter the contact name in the input field to search for it. Press on the contact to start the call.

OR: press a favourite in the telephone interface main menu to start the call.

Calls



The telephone interface shows the call list of the mobile telephone device. Start a call from the call list.


- Press  > **All** and press a number on the list to start the call.

OR: press  and filter the call list entries (for example, missed calls or dialled numbers). In the filtered list, press a number to start the call.

Dial number

Manually enter a phone number to start a call. While entering the phone number, contacts that match that number are shown on the infotainment screen.

- Press  and enter the telephone number. Press  to start the call.

The last call is dialled by pressing and holding the  button on the multifunction steering wheel.

Send messages

Depending on the mobile phone device and the infotainment system used, you can send and receive SMS and e-mails through the telephone interface.

Send an SMS:

1. Press **✉ > Text message > Enter new message** and enter the message on the screen.
2. Enter the contact you want in the search bar.
3. To send the message press **OK**.

Note

For messaging to be available, permissions to share messages must be accepted in the mobile device settings.

Send an email:

- Press **✉ > E-mail > Enter new message** and enter the message on the screen.
- Enter the contact you want in the search bar.
- To send the message press **OK**.

Note

The availability of the E-mail function depends on the connected mobile telephone device and the e-mail apps that are used.

Phone book, favourites and speed dial buttons

When a telephone is first connected to the infotainment system, the phone book is saved in the infotainment system. Data transmission

may have to be confirmed and permissions for sharing contacts on the telephone may have to be accepted.

Each time the phone is reconnected, the phone book is updated.

If conference calls are supported, calls with up to six participants can be made by accessing the phone book during a call. If there is a saved image for a contact, it can be displayed in the list next to the entry.

Favourites


A speed dial button can be assigned to a maximum of six or twelve favourites from the phone book (depending on the Infotainment system fitted to the vehicle). If there is a registered photo saved for the contact, it is shown on the speed dial button.

The dialling buttons have to be edited manually.

Assign the speed dial button

- In the **Favourites** menu, press the **+** button, then open the phone book to select a contact as a favourite. If the contact has several phone numbers, press on the number in the list.

Edit the speed dial button

- To edit or delete a favourite contact press the icon  in the **Favourites** menu screen. You can delete one or more favourites.

Call a favourite

- Press the assigned speed dial button.

Note

Favourites are not updated automatically. If you change a contact's phone number, you have to reassign the speed dial button.

Connectivity Box



Fig. 142 On the centre console: pad for the mobile phone connection.

The Connectivity Box includes the Wireless Charger functionality.

Wireless charger

If your mobile device is equipped with induction charging (Qi) technology, it can be charged wirelessly.

To charge your mobile phone wirelessly:

- Place your mobile device in the middle of the pad with the screen facing up »» Fig. 142, »» ⚠.

Make sure there are no objects between the pad and the mobile phone.

The mobile phone will start charging automatically. For further information about whether your mobile device uses Qi technology, check your phone's user manual or visit the SEAT website

⚠ WARNING

Notifications on the screen of the mobile device can distract the driver's attention and increase the risk of a serious accident.

- Only place one suitable mobile device, with Qi compatibility if applicable. To ensure that it operates properly, place it without the protective case and ensure that it has maximum dimensions (width x length) of 80 x 140 mm (3.15 x 5.512 inches) on the base of the Connectivity Box as indicated.
- If the mobile device is not placed on the base of the Connectivity Box, in the correct position, or if its dimensions exceed those specified, it may not be recognised or may not charge correctly. Under certain circumstances, the infotainment system indicates that there is a foreign object in the storage compartment. Using a suitable mobile phone device and correcting its position can eliminate the fault.

⚠ WARNING

- The mobile phone may become warm due to wireless charging. Think about this before you pick it up, and take care when removing it.
- There must be no metallic or other objects between the mobile phone and the housing, to prevent the functionality of the Connectivity Box from being affected.

ⓘ NOTICE

Do not leave the key near the *Wireless Charger* area as this may cause interference.

ⓘ NOTICE

The base of the Connectivity Box is not removable.

ℹ Note

- Your mobile device must support the Qi inductive charging interface standard for proper operation.
- Charging time and temperature vary depending on the device that is used.
- The maximum charging capacity is 5W.
- Qi technology does not allow simultaneous charging of more than one mobile device.
- You are advised to keep the engine running to guarantee proper wireless charging.

- When a telephone with Qi technology is connected by USB, it will be charged by the means specified by the manufacturer.


Storing objects

Positioning the luggage and cargo

General information

Placing luggage inside the vehicle safely

It is possible to carry objects and luggage in the vehicle, in a trailer »» page 232 and on the roof »» page 230. When doing so, please consider all legal provisions.

- Distribute the load in the vehicle as evenly as possible.
- Always place luggage and heavy objects as far forwards as possible in the luggage compartment »» .
- Take into account the maximum authorised weight per axle, as well as the maximum authorised weight of the vehicle »» page 321.
- Secure the objects to the fastening rings of the luggage compartment using appropriate chains or belts »» page 230.
- Also place small objects safely.
- In vehicles with dynamic headlight range control, the lights adapt automatically.
- Adapt tyre pressure to the load. Take into account the pressure sticker of the tyres »» page 287.

- In vehicles equipped with a tyre pressure control system, adjust to the new load status if necessary »» page 297.

WARNING

Loose or unsecured objects can cause serious injury in case of sudden manoeuvring or braking or in case of an accident. This is particularly the case if the airbag impacts them when deploying and they are thrown across the inside of the vehicle. Please observe the following rules to minimise the risk of injury:

- Place all objects inside the vehicle safely.
- Secure all objects, small and large.
- Place the objects in the vehicle interior in such a way that they can never move into the airbag deployment areas while the vehicle is in motion.
- Keep the storage compartments closed at all times while the vehicle is in motion.
- Place the objects in such a way that they never force any occupant of the vehicle to sit in an incorrect position.
- When transporting objects that take up a seat, never let anyone use that seat.
- Never leave hard, sharp or heavy objects loose in open storage compartment of the vehicle, on the cover behind the rear seat or on the dash panel.
- Remove all hard, sharp or heavy objects from the fabrics and bags in the vehicle interior and store them safely.

WARNING

Transporting heavy objects changes vehicle handling and increases braking distance. Heavy objects that are not properly placed or secured may cause loss of control of the vehicle and thus severe injuries.

- Never put too much load in the vehicle. Both the carrying capacity as well as the distribution of the load in the vehicle have effects on the driving behaviour and braking ability.
- When transporting heavy objects, the driving behaviour of the vehicle varies due to the displacement of the centre of gravity.
- Always distribute the load in the vehicle as evenly and horizontally as possible.
- Always place heavy objects in the luggage compartment in front of the rear axle and as far away from it as possible.
- Objects in the luggage compartment that are unsecured could move suddenly and modify the handling of the vehicle.
- Adapt your speed and driving style at all times to suit visibility, weather, road and traffic conditions.
- Accelerate with particular care and caution.
- Avoid sharp braking and sudden manoeuvres.
- Brake earlier than usual.

NOTICE

Electrical wires or, depending on the features, the antenna embedded into the rear windows could be damaged, even irreparably, if they are in contact with objects.

Note

Straps for securing the load to the fastening rings are commercially available from accessory shops.

Luggage compartment

Luggage compartment shelf

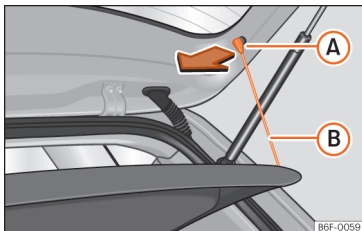


Fig. 143 In the boot: removing and installing the shelf.

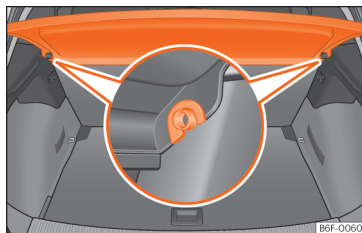


Fig. 144 In the boot: removing and installing the shelf.

Removing

- Detach the cord loops >>> **Fig. 143** **(B)** from their hooks **(A)**.
- Remove the rear shelf from the side supports >>> **Fig. 144** by pulling it upwards and then take it out.

If necessary, the rear shelf can be stored under the luggage compartment double floor >>> page 228.

Fitting

- Insert the cover horizontally so that the “recess” fits onto the axis of the supports >>> **Fig. 144** and press down until it engages.
- Attach the securing straps >>> **Fig. 143** **(B)** onto the rear lid.

WARNING

Animals, loose or unsecured or objects carried on the rear shelf can cause serious injury in case of sudden manoeuvring or braking or in case of an accident.

- Do not leave hard, sharp or heavy objects or in bags on the rear shelf.
- Never transport animals on the rear shelf.

NOTICE

- Before closing the rear lid, ensure that the rear shelf is correctly fitted.
- An overloaded luggage compartment could mean that the rear shelf is not correctly seated and it may be bent or damaged.
- If the luggage compartment is overloaded, remove the tray.

Note

Ensure that, when placing items of clothing on the luggage compartment cover, rear visibility is not reduced.

Store the rear shelf

Depending on the equipment, once the luggage compartment shelf has been removed, it can be stored under the variable floor of the luggage compartment.

- Remove the side cover by sliding it upwards.
- Place the luggage compartment shelf in the space provided for this purpose.
- Place the cover back in its original position.

Variable luggage compartment floor

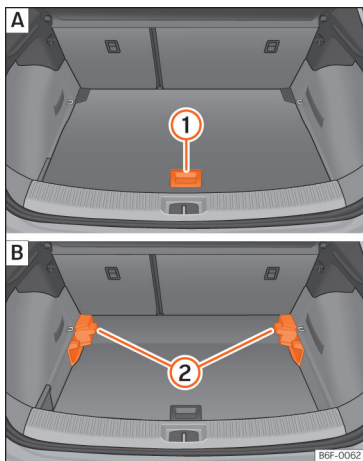


Fig. 145 Variable luggage compartment floor:
A raised position; **B** lowered position.

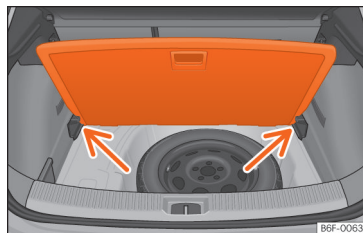


Fig. 146 Variable boot floor: tilted position.

Variable floor in high position

- To move from the low position to the high position, lift the floor using the handle »» Fig. 145 ①, and pull it back until the front of the floor has fully passed the supports ②.
- Move the floor forward over the supports as far as the rear seat backrest and then lower the floor with the handle ①.

Variable floor in low position

- To move from the high position to the low position, lift the floor using the handle »» Fig. 145 ①, and pull it back until the front of the floor has fully passed the supports ②.
- Now let the front part fall to the floor and slide the floor forwards as far as the rear seat backrest; lower the floor at the same time with the handle ①.

Variable floor in the tilted position

When the variable floor is tilted you can access the spare wheel or anti-puncture kit area.

- Lift the variable floor in the high position using handle »» Fig. 145 ①, pull it up and push it towards the backrest of the rear seats until it folds along the hinge line and the movable part of the floor is resting on itself.
- Rest the floor on its housings »» Fig. 146 (arrows).

⚠ WARNING

- Always secure objects, even when the luggage compartment floor is properly lifted.
- Only objects that do not protrude more than 2/3 the height of the floor may be carried between the rear seat and the raised luggage compartment floor.
- Only objects that do not weigh than approximately 7.5 kg may be carried between the rear seat and the raised luggage compartment floor.

NOTICE

- The maximum weight that can be loaded on the luggage compartment variable floor in the top position is 100 kg.
- Do not let the luggage compartment floor fall when closing it. Always carefully guide it downwards in a controlled manner. Otherwise, the lining and the floor of the luggage compartment could be damaged.

Luggage compartment equipment

Fastening rings

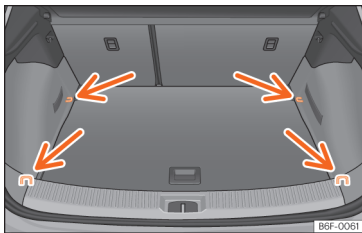


Fig. 147 Location of fastening rings in luggage compartment.

There are fastening rings »» Fig. 147 on the front and rear of the boot to secure loose objects and luggage with fastening belts and cords.

WARNING

If unsuitable or damaged belts or retaining straps are used, they could break in the event of braking or an accident. Objects could then be launched across the passenger compartment and cause serious or fatal injuries.

- Always use belts or straps that are suitable and in good condition.
- Tighten the belts and straps in a cross layout over the load placed on the luggage compartment floor and secure them to the fastening rings safely.
- Never exceed the maximum tensile load of the fastening rings when securing objects.
- Make sure that, particularly for flat objects, the upper edge of the load is higher than the fastening rings.
- Depending on the features, take into account the instruction panels on the boot on how to place the load.
- Never secure a child seat to the fastening rings.

Note

- The maximum tensile load that the fastening rings can support is approx. 3.5 kN.
- Belts, straps and securing systems for the appropriate load can be obtained from specialised dealerships. SEAT recommends visiting a SEAT dealership for this.

Roof carrier

Introduction

The vehicle roof has been designed to optimise aerodynamics. For this reason, cross bars or conventional roof carrier systems cannot be secured to the roof water drains.

As the roof water drains are integrated in the roof to reduce air resistance, only SEAT-approved cross bars and roof carrier systems can be used.

Cases in which cross bars and the roof carrier system should be disassembled.

- When they are not used.
- When the vehicle is washed in a car wash.
- When the vehicle height exceeds the maximum height, for example, in some garages.

⚠ WARNING

- Always secure the load properly using belts or retaining straps that are suitable and in a good condition.
- Bulky, heavy, long or flat loads have a negative effect on aerodynamics, the centre of gravity and driving performance.
- Avoid sudden braking and manoeuvres.
- Adapt your speed and driving style at all times to suit visibility, weather, road and traffic conditions.

ⓘ NOTICE

- Remove the cross bars and the roof carrier system before entering a car wash.
- Vehicle height is increased by the installation of cross bars or a roof carrier system and the load secured on them. For this purpose, check that your vehicle's height does not surpass the headspace limit, for example, for underpasses or for entering garage doors.
- Any cross bars, roof carrier systems or loads secured to them must not interfere with the roof aerial or block the path of the rear lid.
- On opening the rear lid make sure that it does not knock into the roof load.

🌿 For the sake of the environment

When cross bars and a roof carrier system are installed, the increased air resistance means that the vehicle uses more fuel.

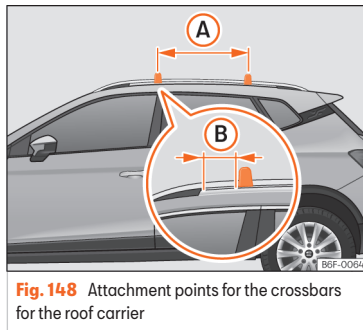
Securing the crossbars and the roof carrier system

Fig. 148 Attachment points for the crossbars for the roof carrier

The crossbars are the basis of a series of special roof carrier systems. For safety reasons, special fixtures must be used to safely transport luggage, bicycles, skis, surf boards or boats on the roof. Suitable accessories can be purchased at SEAT dealerships.

Always secure the crossbars and the roof carrier system properly. Always take the assembly instructions that come with the crossbars and the roof carrier system in question into account.

Installing the bars

The crossbars are assembled on the roof railings. The distance between cross bars >>> **Fig. 148** (A) should be 75 cm and the distance between the cross bars and the brackets of the roof railings (B) should be 5 cm.

⚠ WARNING

Incorrect attachment and use of the crossbars and the roof carrier system may cause the whole system to detach from the roof and cause an accident and injuries.

- Always take the manufacturer assembly instructions into account.
- Check threaded joints and attachments before moving off and if necessary tighten them after you have travelled a short distance. When making long trips, check the threaded joints whenever you stop for a rest.
- Do not modify or repair the crossbars or roof carrier system.

ⓘ Note

Always read the assembly instructions that come with the crossbars and the roof carrier system carefully and keep them in the vehicle.

Loading the roof carrier system

The load can only be secured if the crossbars and the roof carrier system are properly installed »» » ⚠.

Maximum authorised cargo on the roof

The maximum permissible roof load is **75 kg**. This figure comes from the combined weight of the roof carrier, the cross bars and the load itself on the roof »» » ⚠.

Always check the weight of the roof carrier system (roof box, bicycle carrier, ski rack, etc.), of the cross bars and of the load to be transported and weigh them if necessary. Never exceed the maximum authorised roof load.

If you are using cross bars and a roof carrier with a lower weight rating, you will not be able to carry the maximum authorised roof load. In this case, do not exceed the maximum weight limit for the roof carrier which is listed in the fitting instructions.

Distributing a load

Distribute loads uniformly and secure them correctly »» » ⚠.

Check attachments

Once the cross bars and roof carrier system have been installed, check the bolted connections and attachments after a short journey and every so often afterwards (approx. every 200 km).

⚠ WARNING

- **Never exceed the maximum authorised load on the roof and on the axles or the vehicle's maximum authorised weight.**
- **Never exceed the load capacity of the cross bars and the roof carrier system, even if the maximum authorised roof load has not been reached.**
- **Secure heavy items as far forward as possible and distribute the vehicle load uniformly.**

⚠ WARNING

If the load is loose or not secured, it could fall from the roof carrier system or cause accidents and injuries.

- **Always use belts or retaining straps that are suitable and in a good condition.**

Trailer mode

Introduction

Take into account country-specific regulations about driving with a trailer and the use of a towing bracket.

The vehicle has been developed primarily for carrying people, although it can also be used to tow a trailer if fitted with the corresponding technical equipment. This additional load has an effect on the useful life, fuel consumption and vehicle performance and in some cases can reduce the service intervals.

Driving with a trailer requires more force from the vehicle, and thus more concentration from the driver.

In winter, winter tyres should be fitted on both the vehicle **and** the trailer.

Maximum vertical load technically permitted on the coupling device

The *maximum* vertical load technically permitted from the trailer draw bar on the towing bracket's tow ball is **55 kg**.

Vehicles with the Start-Stop system

If the vehicle has a factory-fitted towing bracket or one that is retrofitted by SEAT, the Start-Stop system operates as normal. No special characteristics need to be taken into account.

If the system does not recognise the trailer or the trailer bracket has not been retrofitted by SEAT, the Start-Stop system must be disconnected by pressing the corresponding button in the lower part of the centre console before driving with the trailer, and it should remain off for the rest of the journey >>> ⚠.

Vehicles with driving profile selection

If you are going to be towing a trailer, the use of the **Eco** driving profile is not recommended. You are advised to select another of the available driving profiles before beginning to drive with a trailer.

Trailer weight/drawbar load

Never exceed the authorised trailer weight. If you do not load the trailer up to the maximum permitted trailer weight, you can then climb correspondingly steeper slopes.

The maximum trailer weights listed are only applicable for **altitudes** up to 1000 m above sea level. Since higher altitude decreases engine performance and the ability to climb slopes, the tow load decreases proportionally. The weight of the vehicle and trailer combination must be reduced by 10% for every 1000 m of altitude. When possible, operate the trailer with the maximum **authorised drawbar load** on the ball joint of the towing bracket, but **do not exceed** the specified limit.

⚠ WARNING

Never use the trailer to transport people, since it would put their life in danger and is also prohibited.

⚠ WARNING

Undue use of the towing bracket may cause injury and accidents.

- Only use the towing bracket if it is in a perfect state of repair and is properly secured.
- Never modify or repair the towing bracket in any way.
- In order to reduce the danger of injury in the event of rear-end collisions and to avoid injury to pedestrians and cyclists when parking the vehicle, cover or remove the tow hook when you are not using a trailer.
- According to EU regulation 2021_535 it is not permitted to install a towing device that completely or partially covers the rear number plate.
- Never fit a towing bracket "with weight distribution" or "load compensation". The vehicle has not been designed for this type of towing bracket. The towing bracket could fail and the trailer could be released from the vehicle.

⚠ WARNING

Driving with a trailer and transporting heavy or large objects can affect driving properties and even cause an accident.

- Always secure the load properly using belts or straps that are suitable and in good condition.
- Adapt your speed and driving style at all times to suit visibility, weather, road and traffic conditions.
- Trailers with a high centre of gravity are more likely to overturn than those with a low one.
- Avoid sudden braking and manoeuvres.
- Take great care when overtaking.
- Reduce speed immediately if you notice that the trailer is swaying, however slightly.
- Never drive at more than 80 km/h (50 mph) when towing a trailer [or at more than 100 km/h (60 mph) in exceptional circumstances]. This also applies in countries where driving at higher speeds is permitted. Take into account the speed limit for vehicles with trailers in the corresponding country, as it could be less than the speed limit for vehicles without a trailer.
- Never attempt to "straighten" the towing vehicle and trailer while accelerating.

⚠ WARNING

If the towing bracket has been retrofitted by a non-SEAT workshop, the Start-Stop system must be disconnected manually whenever driving with a trailer. Otherwise the brake system could be damaged and could consequently cause a serious accident or injury.

- Always disconnect the Start-Stop system manually when using a towing bracket that has not been fitted by a SEAT workshop.

i Note

- Before hitching or unhitching a trailer, always deactivate the anti-theft alarm »» page 74. Otherwise, the tilt sensor could cause the alarm to go off.
- Do not drive with a trailer for the engine's first 1000 km »» page 112.
- Some retrofitted towing brackets cover the rear towing eye. In these cases, the towing eye should not be used for tow-starting or for towing other vehicles. For this reason, if the vehicle has been retrofitted with a towing bracket, always keep the tow hook in the vehicle when you remove it.

i Note

- If a removable and retractable tow hook is fitted, it should not be mounted when not in use. In the event of a rear-end collision, the damage to the vehicle could be greater if the tow hook is fitted.

Technical requirements

Vehicles that are **factory**-equipped with a towing bracket meet all the technical and legal requirements for driving with a trailer.

If the **vehicle is retrofitted with a tow bracket**, only a bracket that is authorised for the maximum authorised load of the trailer that is to be towed may be fitted. The towing bracket must be suitable for the vehicle and the trailer and must be properly secured to the vehicle's chassis. Only use a towing bracket that has been authorised by SEAT for this vehicle. Always check and take into account the towing bracket manufacturer's instructions.

Towing bracket fitted on the bumper

Never fit a towing bracket to the bumper or to the area where the bumper is mounted. The towing bracket should not impair the bumper's function. Do not make modifications or repairs to the exhaust system or the brake system. Make regular checks to ensure that the towing bracket is secure.

Engine cooling system

Driving with a trailer increases the load on the engine and cooling system. The cooling system should have sufficient coolant and be prepared for the additional effort involved in driving with a trailer.

Trailer brakes

If the trailer has its own brake system, please take the relevant legal requirements into account. Never connect the trailer's brake system to the vehicle's brake system.

Tow cable

Always fit a cable between the vehicle and the trailer »» page 235.

Trailer tail lights

The trailer's tail lights should comply with the statutory safety regulations »» page 235.

Never connect the trailer's tail lights directly to the vehicle's electric system. If you are not sure that the trailer's electrical connection is correct, have it checked by a specialised workshop. SEAT recommends visiting a SEAT dealership for this.

Exterior mirrors

If you cannot see the area behind the trailer with the exterior mirrors of the towing vehicle, additional mirrors will have to be installed in accordance with the regulations of the country

in question. The exterior mirrors should be adjusted before you start driving and must provide a sufficient field of vision at the rear.

Trailer maximum electricity consumption

Never exceed the values indicated!

Brake lights (total)	84 Watts
Turn signal (on each side)	42 Watts
Side lights (on each side)	50 Watts
Reverse lights (in total)	42 Watts
Rear fog light	42 Watts

⚠ WARNING

If the towing bracket is fitted incorrectly or is not the right one, the trailer could become detached from the vehicle and cause serious injury.

📌 NOTICE

- If the tail lights of the trailer are not correctly connected, the vehicle's electronic system may be damaged.
- If the trailer absorbs excessive electric current, the vehicle's electronic system may be damaged.

- **Never connect the trailer's electric system directly to the electrical connections of the tail lights or any other power sources. Only use the connections intended for providing electric current to the trailer.**

Hitching and connecting a trailer

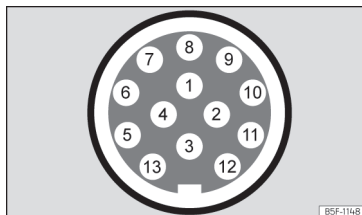


Fig. 149 Diagram: assignment of the pins of the trailer's electrical socket.

Pin	Meaning
1	Left turn signal
2	Rear fog light
3	Earth for pins 1, 2, 4, 5, 6, 7 and 8
4	Right turn signal
5	Rear light, right
6	Brake lights
7	Rear light, left

Pin	Meaning
8	Reverse lights
9	Permanent live
10	Live charge cable
11	Earth for pin 10
12	Unassigned
13	Earth for pin 9

Power socket for trailer

The vehicle is fitted with a 13-pole power socket for the connection between the trailer and the vehicle. With the engine running, electrical devices on the trailer receive power from the electrical connection (pin 9 and pin 10 of the trailer power socket).

If the system detects that a trailer has been connected, the consumers on the trailer will receive electricity through this connection (pins 9 and 10). Pin 9 has a permanent live. This powers, for example, the trailer's interior lighting. Electrical devices such as a fridge in a caravan **only** receive electrical power if the engine is running (through pin 10).

To avoid overloading the electrical system, you cannot connect the ground wires of pin 3, pin 11 or pin 13.

If the trailer has a **7-contact connector**, you will need to use an adapter cable. In this case the function corresponding to pin 10 will not be available.

Tow cable

The tow rope must always be securely fixed to the towing vehicle and loose enough so that the vehicle can handle turns smoothly. However, make sure that the cable does not rub on the ground while driving.

Trailer tail lights

Always check the trailer's rear lights to ensure they are working correctly and that they comply with the relevant safety regulations. Make sure that the maximum permissible power that can be absorbed by the trailer is not exceeded
»» page 234.

Include in the anti-theft alarm

The trailer is included in the anti-theft system if the following conditions are met:

- If the vehicle is factory-equipped with an anti-theft alarm.
- If the vehicle is factory-equipped with a tow bracket.
- If the trailer is electrically connected to the towing vehicle through the trailer power socket.
- If the electrical systems of the vehicle and trailer are in perfect condition and have no faults or damage.
- If the vehicle is locked with the key and the anti-theft alarm is activated.

When the vehicle is locked, the alarm is triggered if the electrical connection with the trailer is cut off.

Before hitching or unhitching a trailer, always turn off the anti-theft alarm. Otherwise, the tilt sensor could cause the alarm to go off.

Trailers with LED tail lights

For technical reasons, trailers fitted with LED rear lights cannot be connected to the anti-theft alarm system.

When the vehicle is locked, the alarm does not go off when the electrical connection with the trailer is cut if it has rear lights with light-emitting diodes.

If the **Eco** driving profile was selected when hitching the trailer, this will automatically switch to the **Normal** profile. If the system cannot detect the attached trailer or if the towing bracket has been retrofitted by an auto repair shop other than SEAT, you must manually select the **Normal** profile before you start driving with a trailer attached. To reconnect the **Eco** profile once the trailer has been unhitched, switch the ignition off and back on once.

WARNING

If the cables are improperly or incorrectly connected, it may lead to an excessive amount of current supplied to the trailer, which can cause abnormalities in the entire vehicle electronic system, as well as accidents and serious injuries.

- Ensure that any repairs that need to be carried out on the electrical system are carried out by a specialised workshop.
- Never connect the trailer's electric system directly to the electrical connections of the tail lights or any other power sources.

WARNING

Contact between the pins of the trailer power socket can cause short circuits, overloading of the electrical system or failure of the lighting system, and consequently can cause accidents and serious injuries.

- Never connect the pins of the trailer power socket to each other.
- Make sure any work on bent pins is carried out by a specialised workshop.


NOTICE

Do not leave the trailer connected to the vehicle when parked; place it on its support wheel or its supports. If the vehicle rises or falls due, for example, to a variation of the load or a burst tyre, increased pressure will be placed on the towing bracket and the trailer, and both the vehicle and the trailer can be damaged.

Note

- In case of anomalies in the electrical systems of the vehicle or trailer, as well as in the anti-theft alarm system, have them inspected by a specialised workshop.
- If the trailer accessories consume energy through the power socket to the trailer and the engine is turned off, the battery will discharge.
- If the vehicle battery is running low, the electrical connection with the trailer will be automatically cut.

Trailer loading**Technically permissible maximum trailer weight and vertical load on the coupling device**

The technically permissible maximum trailer weight is the weight that the vehicle can tow >>> . The vertical load on the coupling is exerted vertically from above on the ball of the towing bracket.

The information on the maximum trailer weight and vertical load on the coupling device contained in the type plate of the towing bracket are experimental values only. The correct figures for your specific model, which may be lower than these figures, are given in the vehicle documentation. The information in the vehicle documentation takes precedence at all times.

To promote safety while driving, SEAT recommends making the most of the maximum technically permitted vertical load on the coupling device >>> **page 232**. An insufficient vertical load has a negative influence on the behaviour of both the vehicle and trailer.

The vertical load increases the weight on the rear axle, reducing the vehicle's carrying capacity.

Gross combination weight of the towing vehicle and trailer

The gross combination weight is the actual weight of the loaded vehicle plus the actual weight of the loaded trailer.

In some countries trailers are classified into different categories. SEAT recommends obtaining information from a specialised workshop regarding which type of trailer is most suitable for your vehicle.

Trailer loading

The weight of the towing vehicle and trailer must be balanced. In order to do this, the load must be as close as possible to the maximum technically permitted vertical load on the coupling point, and it must be evenly distributed between the back and front of the trailer:

- Distribute loads in the trailer so that heavy objects are as near to the axle as possible or above it.
- Secure the trailer load properly.

Tyre pressure

Set the tyre pressure of the trailer tyres in accordance with the trailer manufacturer's recommendations.

When towing a trailer, inflate the tyres of the towing vehicle to the maximum allowable pressure >>> **page 287**.

⚠ WARNING

If the maximum permissible axle weight, the maximum load technically permissible on the coupling point, the maximum authorised vehicle weight or the gross combination weight of the towing vehicle and trailer are exceeded, accidents and serious injuries may occur.

- Never exceed the indicated values.
- The actual weight on the front and rear axles must never exceed the maximum permissible axle weight. The weight on the front and rear axles must never exceed the maximum permissible weight.

⚠ WARNING

A shift in weight could jeopardize the stability and safety of the towing vehicle and trailer, which could lead to accidents and serious injuries.

- Always load the trailer correctly.
- Always secure the load properly using belts or straps that are suitable and in good condition.

Driving with a trailer**Adjusting the headlights**

The front part of the vehicle may be raised when the trailer is connected and the light may dazzle the rest of the traffic.

Adapt the height of the headlights using the headlight range adjuster »» page 93.¹⁾

Specific features of driving with a trailer

- If your trailer has an **overrun brake**, brake *gently at first* and then rapidly. This will prevent the jerking that can be caused by the locking of trailer wheels.
- Due to the gross combination weight of the towing vehicle and trailer, the braking distance increases.
- Use engine braking when descending hills. Otherwise, the brake system could overheat and even fail.
 - *Vehicles with an automatic gearbox:* In Tiptronic mode, select a lower gear.
 - *Vehicles with a manual gearbox:* Shift down.
- The trailer weight, as well as the gross combination weight of the towing vehicle and trailer, change the centre of gravity and the properties of the vehicle.

- If the towing vehicle is empty and the trailer is loaded, then the load distribution is incorrect. Under these conditions, drive slowly and with extra caution.

Hill starts with a trailer

Depending on the slope of the hill and the combination weight of the towing vehicle and trailer, the vehicle might start rolling backwards slightly when you first start up.

For hill starts with a trailer hitched:

- Press and hold the brake pedal.
- *Manual gearbox:* Depress the clutch pedal fully and engage 1st gear.

Automatic gearbox: Move the selector lever to the **D/S** position.

- Apply the parking brake.
- Release the brake pedal.
- Move off slowly.

Manual transmission: release the clutch pedal slowly.

- Do not release the hand brake until the engine is providing sufficient power to move off.

¹⁾ This does not apply for vehicles with Full LED xenon headlights.

⚠ WARNING

If a trailer is pulled incorrectly, this may lead to loss of control of the vehicle and serious injury.



- Driving with a trailer and transporting heavy or large objects will change the vehicle handling and braking distances.
- Always drive cautiously and carefully. Brake earlier than usual.
- Adapt your speed and driving style at all times to suit visibility, weather, road and traffic conditions. Slow down, especially when driving down hills or slopes.
- Accelerate with particular care and caution. Avoid sudden braking and manoeuvres.
- Take great care when overtaking. Reduce speed immediately if you notice that the trailer is swaying, however slightly.
- Never attempt to “straighten” the towing vehicle and trailer while accelerating.
- Take into account the speed limit for vehicles with a trailer, as it could be lower than for vehicles without a trailer.

Stabilisation of the towing vehicle and trailer combination

The stabilisation of the vehicle and trailer combination is an additional function of the electronic stability control (ESC).

If the system detects that the trailer is weaving, it intervenes to reduce the swaying of the trailer.

Vehicle and trailer combination stabilisation requirements

- The vehicle is factory-equipped with a towing bracket or has been retro-fitted with a compatible towing bracket.
- The ESC and TCS are active. The control lamp  or  is not lit up on the instrument cluster.
- The trailer is connected to the towing vehicle through the trailer power socket.
- The vehicle is travelling at over 60 km/h (approx. 37 mph).
- The maximum vertical load technically permissible is not being exceeded on the coupling device.
- The trailer has a rigid draw bar.
- If the trailer has brakes, it must be equipped with a mechanical overrun brake.

⚠ WARNING

The enhanced safety provided by the electric stability control of the vehicle and trailer should not lead you to take any risks that could compromise your safety.

- Adapt your speed and driving style at all times to suit visibility, weather, road and traffic conditions.

- Accelerate with caution when the road is slippery.
- When adjusting any settings, stop accelerating.

⚠ WARNING

The electric stability control for the vehicle and trailer may not correctly detect all driving conditions.

- When the ESC is switched off, the stabilisation of the towing vehicle and trailer is also switched off.
- The stability system does not always detect light trailers, so it may not stabilise these correctly.
- When driving on surfaces with poor grip, the trailer can even interfere with the stabilisation system.
- Trailers with a high centre of gravity can tip over without having previously weaved.
- If a trailer is not attached, but a connector is plugged into the power socket (e.g. installation of a bicycle rack with lights), repeated automatic braking may occur in extreme driving conditions.

Installing a rear carrier system or a bicycle rack on the trailer hitch

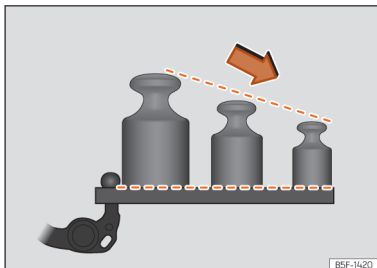


Fig. 150 Recommended weight distribution on the rear support system.

Examples of rear carrier systems are bicycle racks or multi-purpose boxes that are installed on the trailer hitch.

Only use rear carrier systems that have been specified by the respective manufacturer for the vehicle model, model year and version of the vehicle in question » » » **Δ**.

SEAT recommends the use of genuine SEAT spare parts and accessories, which can be purchased from the brand's dealers. Install the rear carrier system according to the manufacturer's installation instructions.

The load capacity results from the weight of the rear carrier system and the weight of the load carried on it.

The recommended maximum load capacity of the rear carrier system installed on the trailer hitch may be different from the maximum vertical load on the specific vehicle coupling.

However, it is not permitted to exceed the maximum permitted vertical load on the tow hitch (which depends on the model).

The load capacity is reduced due to the lever effect that occurs the further the carrier system is from the ball head.

Place heavy objects as close as possible to the trailer hitch » » » **Fig. 150**.

Maximum load capacity depending on the vehicle

To find out the recommended load capacity for your vehicle, check the maximum vertical load on its coupling » » » **page 321**. Please refer to the following table for the load capacity.

In accordance with the UN-R-55 guideline, SEAT recommends not carrying more bicycles than recommended on the rear rack system.

Maximum vertical load on the vehicle's specific coupling	Maximum load capacity	Number of bicycles
50 kg	50 kg	2
55 kg	55 kg	2
From 75 kg	75 kg	3

Maximum load overhang of the rear carrier system

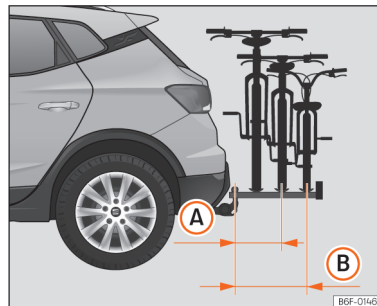


Fig. 151 Schematic representation of the maximum load overhang of a bicycle rack for two or three bicycles.

- A** With up to 55 kg load capacity: 500 mm (approx. 19.7 in)
- B** With 75 kg load capacity: 700 mm (approx. 27.6 in)

The maximum overhang shall not exceed 500 mm from the centre of the ball head to the centre of the rail of the last support » » » **Fig. 151 A** for two-bicycle racks. In the case of three-bicycle racks, the overhang must not exceed 700 mm » » » **Fig. 151 B**.

⚠ WARNING

The incorrect use of a rear carrier system installed on the tow hook can cause accidents and injury.

- Make sure that the carrier system is suitable for your vehicle.
- Read and observe the installation instructions of the rear carrier system manufacturer.
- Never attach a rear carrier system below the ball head of the trailer hitch. The system could slip due to the shape of the hitch.

📄 Note

Before setting off, SEAT recommends removing, to the extent possible, all accessories from the load attached to the carrier system. Examples of these accessories are baskets and panniers, child seats or batteries. This improves the aerodynamics and centre of gravity of the rear carrier system.

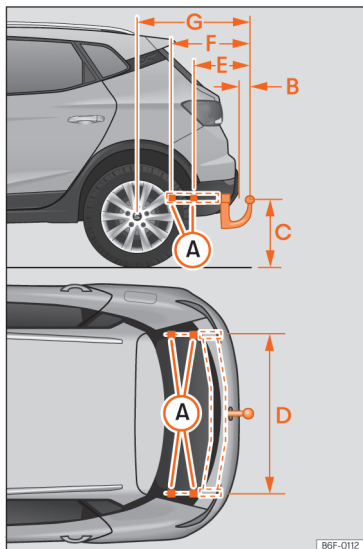
Retrofitting a towing bracket

Fig. 152 Limits and attachment points for retrofitting a towing bracket.

Distance measurements:

- Ⓐ Attachment points [lower part of the vehicle]
- Ⓑ 65 mm [minimum]

- Ⓒ 350 mm to 420 mm [fully laden vehicle]
- Ⓓ 1025 mm
- Ⓔ 322 mm
- Ⓕ 448 mm
- Ⓖ 854 mm

SEAT recommends that towing brackets be retrofitted at a specialised workshop. For example, it may very well be necessary to adjust the cooling system or mount thermal protection plates. SEAT recommends visiting a SEAT dealership for this.

If a towing bracket is retrofitted, the distance specifications should always be kept in mind.

The distance between the centre of the ball head and the road »»» Fig. 152 Ⓒ must never be less than that indicated. This also applies when the vehicle is fully loaded, including the technically permissible maximum vertical load on the coupling device.

⚠ WARNING

If the cables are improperly or incorrectly connected, this may lead to malfunctions in the entire vehicle electronic system, as well as to accidents and serious injuries.

- Never connect the trailer's electric system to the electrical connections of the tail lights or any other unsuitable power sources. Only use suitable connectors to connect the trailer.
- The towing bracket should be retrofitted only at a specialised workshop.

⚠ WARNING

If the towing bracket is badly fitted or unsuitable, the trailer may separate from the vehicle while driving. This could cause serious accidents and fatal injuries.

i Note

- According to regulation EU2021_535 it is not permitted to install a towing device that cannot be removed or retracted.
- Only use towing brackets that have been approved by SEAT for the model in question.
- In some versions, the fitting of a conventional towing hook solution is not recommended. Please consult your Technical Service.

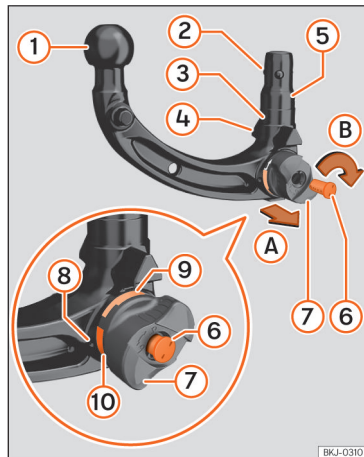
Towing device**Fitting the removable tow hitch**

Fig. 153 Overview: removable tow hitch.

- ① Spherical head
- ② Locking balls
- ③ Locking mechanism (ball)
- ④ Centring guides
- ⑤ Stem
- ⑥ Key

- ⑦ Key slot cover
- ⑧ Thumbwheel
- ⑨ Green mark on the tow hitch
- ⑩ Red mark on the thumbwheel

The removable tow hitch is located in the luggage compartment, either in a side storage compartment or under the floor.

First step: preparations

1. Before using the removable tow hitch, note the number engraved on the key
 >>> **Fig. 153** ⑥ in case it is necessary to make a duplicate.
2. Remove the cover from the tow hitch housing, located underneath the rear bumper and store it in the vehicle.
3. From the top right side, move the trailer socket as far as possible towards the lower left side. This makes the towbar housing accessible.
4. Check that the housing, the thumbwheel
 >>> **Fig. 153** ⑧, the stem ⑤ and the locking balls ② of the tow hitch are clean and in good condition. Clean them if necessary.

Step 2: Check that the tow hitch is pre-tensioned

The tow hitch must be pre-tensioned before it can be installed correctly.

The following conditions must be met:

- The red mark »» Fig. 153 ⑩ on the thumbwheel points towards the green mark ⑨ on the tow hitch.
- The thumbwheel ⑧ is clearly separated from the tow hitch by at least 4 mm [0.2 in].
- All locking balls ② can be fully engaged on the stem ⑤.
- The key ⑥ is inside the lock, the arrow on the key is pointing towards the *lock open* symbol on the thumbwheel ⑧ and the key cannot be removed.

If all of these conditions are met, proceed to **step four**.

If these conditions are not met, continue with **step three**.

Step 3: pre-tensioning the tow hitch

If the tow hitch is not pre-tensioned, pre-tension it as follows:

1. Open the lock cover »» Fig. 153 ⑦ and insert the key into the lock.
2. Turn the key ⑥ counterclockwise until the arrow on the key points towards the *lock open* symbol on the thumbwheel ⑧.
3. Hold the tow hitch with one hand. With the other, pull out the thumbwheel ⑧ in direction A.
4. Turn the extracted thumbwheel ⑧ in direction B as far as the stop.

Step 4: fitting the pre-tensioned tow hitch to the vehicle

Once the tow hitch has been pre-tensioned, do not touch the thumbwheel again »» Fig. 153 ⑧. When the tow hitch is locked, the thumbwheel rotates to its original position and can cause injury »» A.

1. Insert the pre-tensioned tow hitch into the housing tube, from the bottom.
2. Firmly press the tow hitch upwards until it locks in place. The tow hitch is locked in place when:
 - The green mark on the thumbwheel ⑨ faces upwards.
 - The hitch is locked with the key ⑥ and the key can be removed.
 - There is no longer any gap between the thumbwheel ⑧ and the hitch.
3. Turn the key ⑥ clockwise to lock the hitch.
4. Close the lock cover ⑦.

Step 5: safety check

Before hitching a trailer, check that the tow hitch is attached correctly.

- Forcefully move the hitch several times from side to side to check that the housing bushing is properly fixed in place.
- The green mark on the thumbwheel »» Fig. 153 ⑨ faces upwards.
- The thumbwheel ⑧ is right next to the hitch and can be locked.

- The hitch is locked and the key ⑥ removed.
- It is no longer possible to pull the thumbwheel ⑧ sideways.

Safety cable

In some countries, both brakeless and braked trailers must be secured with a safety or break-away cable.

Take into account country-specific regulations about using a safety cable.

1. Attach the safety cable or the breakaway cable to the eye provided for it on the tow hitch.
2. Insert the cable through the ring and hook it onto the carabiner »» A.

⚠ WARNING

Undue use of the towing bracket may cause injury and accidents.

- **Never unlock the tow hitch when a trailer is hitched to it.**
- **Only use the tow hitch when it is correctly attached.**
- **Do not use the tow hitch if the diameter of the spherical head »» Fig. 153 ① is less than 49 mm [1.9 in] any any point.**
- **The tow hitch is heavy. When performing the safety check, it could jump out of its housing and cause bruising.**

- Once the tow hitch is pre-tensioned, do not touch the thumbwheel again. When the hitch fits into its housing, the thumbwheel returns to its original position.

- If it is not possible to fit the tow hitch, go to a properly qualified specialised workshop and request an inspection of the tow hitch. SEAT recommends a SEAT dealership.

- Never use the hitch if it does not fit correctly or cannot be pre-tensioned.

- Never use the tow hitch if, once the hitch has been fitted, the key cannot be removed. This means that the hitch is not locked correctly.

- After removing the tow hitch, always store it safely in the luggage compartment.

⚠ WARNING

If the trailer is not secured correctly, injuries and accidents can occur.

- Never place the trailer's safety or break-away cable loosely over the tow hitch.

ⓘ NOTICE

Fitting an unsuitable tow hitch could cause damage to the vehicle and its approval could be lost.

- Use the factory supplied tow hitch or one that has been approved for your vehicle model and model year. SEAT recommends the use of genuine SEAT spare parts and accessories, which can be purchased from the brand's dealers.

ⓘ NOTICE

- The housing on the vehicle, the thumbwheel, the step and the locking balls of the tow hitch must be clean and in good condition. Otherwise, it may not be possible to lock the hitch correctly.

- If you clean the vehicle with high pressure or steam equipment, do not direct the jet directly at the hitch housing, as this may remove the grease required for lubrication from the housing.

Removing the tow hitch

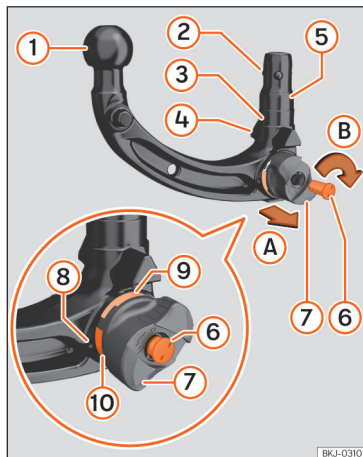


Fig. 154 Overview: removable tow hitch.

- ① Spherical head
- ② Locking balls
- ③ Locking mechanism (ball)
- ④ Centring guides
- ⑤ Stem
- ⑥ Key
- ⑦ Key slot cover
- ⑧ Thumbwheel

- ⑨ Green mark on the tow hitch
- ⑩ Red mark on the thumbwheel
1. Park the vehicle.
 2. Unhook the trailer and disconnect the electrical connection between it and the vehicle. If you are using an adapter, remove it from the trailer socket.
 3. Open the lock cover »» Fig. 154 ⑦ and insert the key ⑥ into the lock.
 4. Turn the key ⑥ counterclockwise until the arrow on the key points towards the lock open symbol on the thumbwheel ⑧.
 5. Hold the tow hitch with one hand. With the other, pull out the thumbwheel ⑧ in direction A.
 6. Turn the extracted thumbwheel ⑧ in direction B as far as the stop.
 7. Pull the tow hitch downwards out of the housing.
 8. Release the thumbwheel ⑧.
 9. Store the tow hitch in the luggage compartment, either in the side storage compartment or under the floor.

⚠ WARNING

The removable tow hitch is heavy. When removing it it can fall and cause bruising.

- Never unlock the tow hitch when a trailer is hitched to it.

Fuel and exhaust gas cleaning

Refuelling

Safety warnings regarding fuel handling

⚠ WARNING

Fuel is highly flammable and can cause serious burns and other injuries.

- When refuelling, turn off the engine and turn off the ignition for safety reasons.
- Do not smoke when filling the fuel tank or a canister. Naked flames are forbidden in the vicinity due to the risk of explosion.
- Observe legislation governing the use, storage and carrying of a spare fuel canister in the vehicle.
- For safety reasons we do not recommend carrying a spare fuel canister in the vehicle. In an accident the canister could be damaged and could leak.
- If, in exceptional circumstances, you have to carry a spare fuel canister, please observe the following points:
 - Never fill fuel into the spare fuel canister if it is inside or on top of the vehicle. This could cause an explosion. Always place the canister on the ground to fill it.

- Insert the filling nozzle as far as possible into the spare fuel canister.
- If the spare fuel canister is made of metal, the filling nozzle must be in contact with the canister during filling. This helps prevent an electrostatic charge building up.
- Never spill fuel in the vehicle or in the luggage compartment. Fuel vapour is explosive. Risk of fatal accident!

ⓘ NOTICE

- If any fuel is spilt onto the vehicle, it should be removed immediately. It could otherwise damage the paintwork.
- Never run the tank completely dry. The catalytic converter can be damaged.

♻ For the sake of the environment

Do not overfill the fuel tank, it may cause the fuel to overflow if it becomes warm.

ⓘ Note

There is no emergency mechanism for the manual release of the fuel tank flap. If necessary, request assistance from specialised personnel.

Refuelling

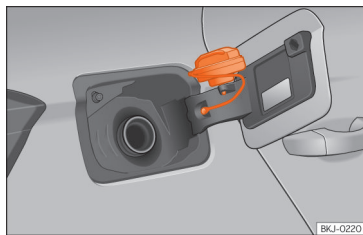


Fig. 155 Fuel tank flap with tank cap attached.

The fuel tank flap is on the rear right of the vehicle.

- The tank flap is unlocked when the car is unlocked using the central locking remote control >>> page 70.
- Open the fuel tank flap by pressing on the retainer zone.
- Unscrew the cap by turning it to the left.
- Place it in the space on the hinge of the open flap >>> **Fig. 155**.
- Start refuelling. The tank is full as soon as the pump's automatic nozzle cuts off the fuel supply. Do not try to put in more fuel after the nozzle cuts out, as this will fill the expansion chamber in the fuel tank.
- Unscrew the cap by turning it to the right as far as it will go.
- Close the lid.

The correct fuel grade for your vehicle is given on a sticker on the inside of the fuel tank flap. Further notes on fuel can be found at **>>> page 247**.

The capacity of your vehicle's fuel tank is given in **>>> page 321**.

Fuel types

Identification of fuels¹⁾

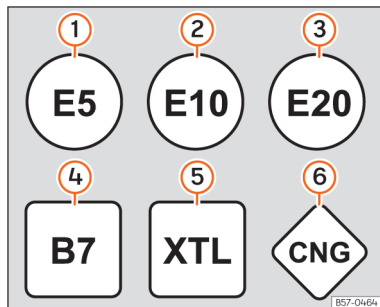


Fig. 156 Identification of fuels according to European Union (EU) Directive 2014/94/

Fuels are identified by different **symbols on the pump and on your vehicle's tank flap**. This identification avoids confusion when selecting the fuel

- ① Means **petrol** with a maximum of 5% Ethanol.
- ② Means **petrol** with a maximum of 10% Ethanol.
- ③ Means **petrol** with a maximum of 20% Ethanol.
- ④ **Diesel** according to EN590 standard. The number indicates the maximum percentage of Biodiesel in the fuel. "B7" means a maximum of 7% Biodiesel.
- ⑤ Synthetic **diesel** according to the EN15940 standard.
- ⑥ **Natural gas**: "CNG" means **C**ompressed **N**atural **G**as

Type of petrol

The correct grade of petrol is listed inside the fuel tank flap.

The vehicle is equipped with a catalytic converter and must only be run on **unleaded petrol**. The petrol must comply with the standard EN 228 and be **sulphur-free**. Follow the regulations of the country you are driving in. The types

of petrol are differentiated by using the **octane numbers (RON)** or via the **anti-knock index (AKI)**.

Super unleaded petrol 95 octane petrol or normal 91 octane petrol at least

We recommend refuelling with super 95 octane petrol (91 AKI). If not available, normal 91 octane petrol (87 AKI) (with a slight power loss) may be used.

Super unleaded petrol, 95 octanes at least

You should use super 95 octane petrol (91 AKI) at least.

If super petrol is not available, if necessary, use normal 91 octane petrol (87 AKI). In this case only use moderate engine speeds and a light throttle. Refuel with super as soon as possible.

Unleaded super plus 98 octane petrol or super 95 octane petrol at least

We recommend refuelling with super plus 98 octane petrol (93 AKI). If not available: super 95 octane petrol (91 AKI) (with a slight power loss).

If super petrol is not available, if necessary, use normal 91 octane petrol (87 AKI). In this case only use moderate engine speeds and a light throttle. Refuel with super as soon as possible.

¹⁾ Depending on the country.

NOTICE

- Fuels with a high percentage of ethanol, e.g. E30 - E100 button must not be used. The fuel system would be damaged.
- A single refuelling with leaded fuel or other metal additives entails a permanent deterioration of the effectiveness of the catalytic converter.
- Only petrol additives that have been approved by SEAT S.A. should be used. Products containing substances to increase the octane rating or decrease knocking may contain metal additives that damage the engine and catalytic converter. These type of products must not be used.
- Do not use fuels shown in the pump as containing metals. LRP (*lead replacement petrol*) fuels contain high concentrations of metal additives. Risk of engine damage!
- High engine speed and full throttle can damage the engine when using petrol with an octane rating lower than the correct grade for the engine.

Note

- Fuel with an octane rating higher than the one required by the engine can be used.
- In countries in which there is no sulphur-free fuel, fuel with a low sulphur content may also be used.

Ethanol fuel

- ✓ Valid for: vehicles with Totalflex engines

You can recognise vehicles with Totalflex engines¹⁾ by a label on the fuel tank flap with the marking "Petrol/ethanol".

Vehicles with Totalflex engines can run with unleaded petrol (95 octane / 91 AKI) according to ANP No. 57 and with fuels with any high percentage of ethanol. The vehicle is refuelled in the same way as petrol refuelling.

Also consider that »» page 247, *Type of petrol*.

Note

SEAT recommends filling the tank exclusively with petrol every 10,000 km to decrease impurities that using E100 ethanol fuel might have left in the engine.

Engine management and emissions control system

Introduction

WARNING

Due to the high temperatures reached by the exhaust gas scrubbing system, you should not park your vehicle near a surface that can catch fire easily. Fire hazard!

WARNING

Do not apply wax underneath the vehicle around the area of the exhaust system: Fire hazard!

Catalytic converter


To maintain the useful life of the catalytic converter

- Only use unleaded petrol with petrol engines.
- Never run the fuel tank dry.

¹⁾ This engine is only available in some markets.

• When changing or adding engine oil, do not exceed the necessary amount »» page 277, *Checking and topping up the engine oil level*.

• Never tow the vehicle to start it, use jump leads if necessary »» page 253.

If you notice misfiring, uneven running or loss of power when the car is moving, have the vehicle inspected by a specialised workshop. In general, the emissions warning lamp  will light up when any of these symptoms occur. If this happens, any unburnt fuel can enter the exhaust system and escape into the atmosphere. The catalytic converter can also be damaged by overheating.

NOTICE


Never run the fuel tank completely dry because an irregular fuel supply can cause ignition faults. This allows unburnt fuel to enter the exhaust system, which could cause overheating and damage the catalytic converter.

For the sake of the environment

Even when the emission control system is working perfectly, there may be a smell of sulphur from the gases on occasions. This depends on the sulphur content of the fuel used. This can quite often be avoided by changing to another brand of fuel.

Particulate filter

The particulate filter eliminates most of the soot from the exhaust gas system. Under normal driving conditions the filter cleans itself. If the filter does not clean itself (e.g. if short journeys are made continuously), it becomes blocked with soot and the following indication is displayed to the driver:

 **Particulate filter: cleaned while the vehicle is moving. See Manual.**

The particulate filter needs cleaning (regeneration).

Regeneration of the petrol particulate filter

Requirements for the regeneration journey: the engine is at operating temperature.

- Drive at a speed of between 50/120 km/h (31-75 mph). This increases the temperature and burns the soot in the filter »» page 249.
- Consider the legal speed limits as well as the recommended gears.
- End the regeneration journey once the control warning lamp has gone out.

If the warning lamp stays on after 30 minutes of running in regeneration mode, have a specialised workshop repair the fault.

WARNING

Always adjust your speed to suit the weather conditions, roads, braking distance and traffic if the particulate filter is in its regeneration phase. Route recommendations should never make you disregard each country's specific traffic regulations.

NOTICE

- When the exhaust system detects that the particulate filter is close to saturation, the self-cleaning function of this system recommends optimal driving for this function.
- Due to the high temperatures caused by the regeneration of the particulate filter, it is possible that the radiator fan will activate after stopping the engine, even if its operating temperature has not been reached.
- Noise, smells and high idle speeds can occur during regeneration.
- Always use the correct engine oil and the correct fuel to make sure the useful life of the particulate filter is not affected. Also avoid making short trips all the time.

Troubleshooting

 **Fault in the emission control system.**

The indicator lamp lights up yellow.

Reduce speed and drive carefully to the nearest specialised workshop to have the engine checked.



Combustion failures that can damage the catalytic converter.

The control lamp flashes yellow.

Reduce speed and drive carefully to the nearest specialised workshop to have the engine checked.



Particulate filter blocked

The indicator lamp lights up yellow

»» page 249..



EPC Fault in the petrol engine management.

The indicator lamp lights up yellow.

Have the engine checked as soon as possible by a specialised workshop.

When the ignition is switched on, the EPC (Electronic Power Control) lamp lights up and should go off once the engine has started.

NOTICE

While the control lamps ,  or EPC are on, there might be faults in the engine, fuel consumption may go up and the engine might lose power.

Miscellaneous situations

Vehicle tool kit

On-board toolkit

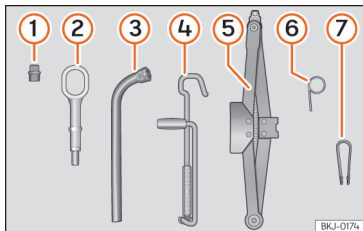


Fig. 157 Underneath the floor panel of the luggage compartment: on-board tools.

The vehicle tool kit is located under the floor panel in the luggage compartment. To access the on-board tools »» page 229.

The tool kit includes:

- ① Adapter for the anti-theft bolt
- ② Towing eye, removable
- ③ Wheel spanner
- ④ Crank handle for jack
- ⑤ Jack

- ⑥ Hook for extracting the central wheel trims
- ⑦ Clip for removing the wheel bolt caps

Some of the items listed are only provided in certain model versions, or are optional extras.

⚠ WARNING

When the vehicle tool kit, tyre mobility set and spare wheel are loose in the interior they can be violently thrown in case of a sudden manoeuvre or braking and especially in accidents, causing serious injury.

- Ensure that the vehicle tool kit, the tyre mobility set and the spare wheel or temporary spare wheel are safely secured in the luggage compartment.

⚠ WARNING

Unsuitable or damaged vehicle tools can cause injury or accidents.

- Never work with inappropriate or damaged tools.

i Note

The jack does not generally require any maintenance. If required, it should be greased using universal type grease.

Changing the windscreen wiper blades

Wiper service position

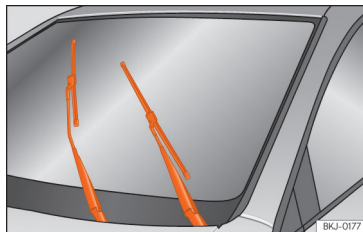


Fig. 158 Wipers in service position.

Ensure that the wiper blades are not frozen.

With the wipers in service position, it is possible to fold the wiper arms »» Fig. 158.

- Close the bonnet »» page 267.
- Switch the ignition on and off.
- Briefly press the wiper lever downwards.

Before driving, always lower the wiper arms. Using the windscreen wiper lever, the windscreen wiper arms return to their initial position.

 Note

- The wiper arms can be moved into the re-
placement position when the front bonnet is
fully closed.
- You can also use the service position, for
example, if you want to fix a cover over the
windscreen in the winter to keep it clear of
ice.

Changing the wiper rear wiper blades

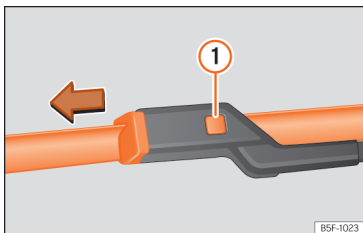


Fig. 159 Changing the windscreen wiper blades

The windscreen wiper blades are supplied as standard with a layer of graphite. This layer is responsible for ensuring that the wipe is silent. If the graphite layer is damaged, the noise of the water as it is wiped across the windscreen will be louder.

Check the condition of the wiper blades regularly. **If the wipers scrape across the glass**, they should be changed if they are damaged, or cleaned if they are dirty >>> ①.

If this does not produce the desired results, the setting angle of the windscreen wiper arms might be incorrect. They should be checked by a specialised workshop and corrected if necessary.

Damaged windscreen wiper blades should be replaced immediately. These are available from qualified workshops.

Raising and lowering windscreen wiper arms

- Place the windscreen wipers in the service position >>> page 251.
- Grip the wiper arms **only** by the blade's fastening point.

Cleaning windscreen wiper blades

- Raise the wiper arms.
- Use a soft cloth to remove dust and dirt from the windscreen wiper blades.
- If the blades are very dirty, a sponge or damp cloth may be used >>> ①.

Changing the windscreen wiper blades

- Lift and unfold the wiper arms.
- Press and hold release button >>> Fig. 159 ① and pull gently on the wiper blade in the direction of the arrow.

- Fit a new wiper blade of the **same length and design** on to the wiper arm and hook it into place.
- Rest the wiper arms back onto the windscreen.

Changing the rear window wiper blade

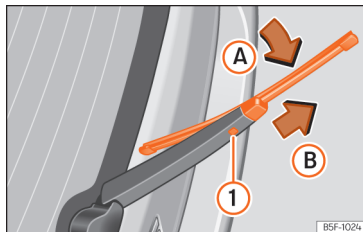


Fig. 160 Changing the rear wiper blade

- Separate the wiper arm from the rear window.
- Rotate the blade lightly >>> Fig. 160 (arrow A).
- Hold down the release button ① while gently pulling the blade in the direction of arrow B.
- Insert a new blade of the **same length and type** in the rear wiper arm in the opposite direction to the arrow B until button ① hooks into place.
- Fold the wiper arm and rest it on the window.

⚠ WARNING

Worn or dirty windscreen wiper blades reduce visibility and increase the risk of accident and serious injury.

- Always replace damaged or worn windscreen wiper blades or blades that no longer clean the windscreen properly.

ⓘ NOTICE

- Damaged or dirty windscreen wipers could scratch the glass.
- If products containing solvents, rough sponges or sharp objects are used to clean the blades, the graphite layer will be damaged.
- Never use fuel, nail varnish remover, paint thinner or similar products to clean the windows.
- In icy conditions, always check that the wiper blades are not frozen to the glass before using the wipers. In cold weather, it may help to leave the vehicle parked with the wipers in service position >>> page 251.

ⓘ NOTICE

- To prevent damage to the bonnet and the wiper arms, only leave them in the service position.
- Before driving, always lower the wiper arms.

Jump start

Introduction

If the engine fails to start because of a discharged 12-volt battery, the battery can be connected to the battery of another vehicle to start the engine.

Jump leads complying with the **DIN 72553 standard** are needed for starting (see cable manufacturer's instructions). The wire cross section must be at least 25 mm² for petrol engines and at least 35 mm² for diesel engines.

ⓘ NOTICE

To avoid considerable damage to the vehicle electrical system, take careful note of the following:

- If the jump leads are connected incorrectly, a short circuit may occur.
- Use only jump leads with fully insulated clamps.
- Do not allow the vehicles to come into contact with each other, otherwise current may start to flow as soon as the positive poles are connected.

Jump start: description

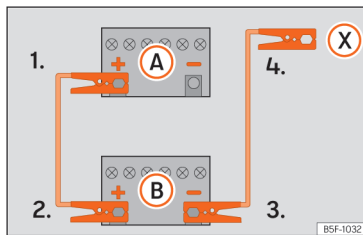


Fig. 161 Wiring diagram for vehicles without a start/stop system.

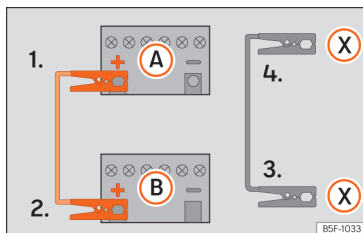


Fig. 162 Wiring diagram for vehicles with a start/stop system.

The discharged battery must be properly connected to the on-board network.

Make sure that the clamps have sufficient metal contact when connecting them to the poles.

Jump lead terminal connections

The jump leads should only be connected in the order **1 > 2 > 3 > 4** »» Fig. 162.

- Switch off the ignition of both vehicles »» ⚠.
- Connect one end of the *red* jump lead to the positive (+) terminal of the vehicle with the flat battery (A).
- Connect the other end of the *red* jump lead to the positive terminal (+) in the vehicle providing assistance (B).
- Vehicles without a Start-Stop system:* connect one end of the black jump lead to the negative terminal (-) of the vehicle providing the current (B) »» Fig. 161. *Vehicles with a Start-stop system:* connect one end of the black jump lead (X) to a suitable ground terminal, to a solid piece of metal in the engine block, or to the engine block itself »» Fig. 162.
- Connect the other end of the *black* jump lead (X) to a suitable ground terminal, a solid metal component bolted to the engine block or to the engine block itself of the vehicle with the flat battery. Do not connect it to a point near the battery A.
- Position the leads in such a way that they cannot come into contact with any rotating part in the engine compartment.

Starting

- Start the engine of the vehicle supplying the current and leave it running at idle.
- Start the engine of the vehicle with a discharged battery and wait 2 to 3 minutes until the engine runs.

Disconnecting the jump leads

- Before disconnecting the jump leads, switch off the dipped beam headlight if it is on.
- Turn on the heating fan and the vehicle's heated rear window when the battery is discharged to reduce the voltage peaks that occur while disconnecting the battery.
- While the engines are still running, disconnect the cables in the reverse order in which they were connected.

If the engine does not start after 10 seconds, wait for approximately 1 minute and then try again.

⚠ WARNING

- Please note the safety warnings referring to working in the engine compartment »» page 267.
- The battery supplying the current must have the same voltage (12V) as the flat battery. Failure to comply could result in an explosion.

- Never use jump leads when one of the batteries is frozen. Danger of explosion! Even once thawed, electrolyte leaks can cause burns. Replace the battery if it is frozen.
- Keep any sources of ignition (flames, cigarettes, etc.) far enough away from the batteries. They may cause an explosion.
- Observe the usage instructions of the jump lead manufacturer.
- On the other vehicle, do not connect the negative cable directly to the negative terminal of the discharged battery. Any sparks could ignite the igniter gas coming out of the battery and could cause an explosion.
- The negative wire must never be connected to fuel system components or brake lines on the other vehicle.
- Do not touch uninsulated parts of the pole clamps. The jump lead attached to the positive battery terminal must not touch metal parts of the vehicle, this can cause a short circuit.
- Jump leads must be placed in such a way that they cannot be caught by rotating parts in the engine compartment.
- Do not rest your body on the batteries, as this could cause burns.
- Take into account the instruction manual of the jump lead manufacturer and the instruction manual of the other vehicle.

NOTICE

Immediately go to a specialist workshop and have the 12 volt battery checked.

Towing the vehicle

Introduction

It takes practice to tow a vehicle, especially when using a tow cable. Both drivers should be well informed of the special features of towing. Inexperienced drivers should refrain from towing.

During towing, make sure at all times that no inadmissible pulling forces or jolts are caused. On roads without a firm surface there is always the danger of overloading the attachment parts.

Take into account the legal provisions regarding tow starting and towing.

Tow start

Tow starting means starting a vehicle's engine while another puts it in motion by pulling it.

The vehicle can be tow started with a tow bar or cable.

Towing

Towing means a vehicle pulling another vehicle that is not in a condition to drive.

The vehicle can be towed with a tow bar or cable.

- The speed limit is 50 km/h (30 mph).
- The maximum permitted distance is 50 km (30 miles).

Tow cable and tow bar

It is safer for the vehicle to be towed using a tow bar, avoiding damage to the vehicle. The tow cable should only be used if a tow bar is not available.

A tow rope should be slightly elastic to avoid damage to both vehicles. It is advisable to use a tow rope made of synthetic fibre or similarly elastic material.

Towing with a tow truck

If a breakdown lorry is used, vehicles with automatic transmission are only allowed to be towed with the front wheels suspended.

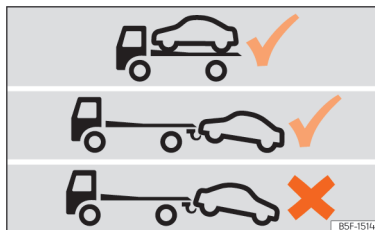


Fig. 163 Transport with a tow truck: vehicles with an automatic gearbox.

WARNING

When towing a vehicle, the driving behaviour and braking capacity change considerably.

WARNING

Never allow the vehicle to be towed if it has no power.

- When towing, never remove the key from the ignition or disconnect the ignition with the ignition and start button. Otherwise, the electronic lock of the steering column could suddenly get blocked and it would be impossible to steer the vehicle. This could cause an accident, serious injury and loss of control of the vehicle.
- If the vehicle runs out of power during towing, stop the process immediately and seek the assistance of specialised personnel.

NOTICE

Towing the vehicle with a tow cable or a tow bar can cause damage to the vehicle.

- If the vehicle is towed with a tow cable or tow bar, special care must be taken.
- If possible, have the vehicle transported on a tow truck.

NOTICE

If the vehicle is pushed by hand, the tail light units, the side spoilers of the rear window and large sheet metal surfaces may be damaged. In addition, the rear spoiler could be detached.

- If the vehicle is pushed by hand, the tail light units, the side spoilers of the rear window, large sheet metal surfaces or the rear spoiler.

NOTICE

Removing and attaching the cover and the towing eye may cause damage to the vehicle, for example, on the paintwork.

- To avoid damaging the vehicle, remove and replace the cover and the towing eye carefully.

NOTICE

Using a towing eye that is not suitable for the vehicle can damage it.

- When towing, always use the vehicle's towing eye, which forms part of the on-board tools, or an appropriate eye for towing.

Instructions for tow-starting and towing

During towing, the change of direction can be signalled on the towed vehicle even when the hazard warning lights are on. To do so, at the same time, the turn signal lever must be operated with ignition switched on. During this time the hazard warning lights remain disconnected. When the turn signal lever is returned to the neutral position, the hazard warning lights will be automatically reactivated.

Cases where tow starting and towing the vehicle are not permitted

Do not allow the vehicle to be towed in the following situations:

- The vehicle's gearbox is damaged or has no lubricant.
- The 12-volt battery is discharged. In vehicles with the "Keyless Access" locking and ignition system the steering remains locked and the parking brake cannot be deactivated and the steering column lock cannot be released if they are connected.

- If a distance above 50 km needs to be travelled.
- There is no guarantee that the wheels will turn smoothly or that the steering will work after an accident.

If the vehicle cannot be towed on its wheels for any of the reasons mentioned above, request assistance from specialised personnel and, if necessary, have the vehicle transported without the wheels touching the ground.

Tow start**Steps to be taken prior to tow starting**

Vehicles with an automatic gearbox: Due to technical reasons, tow starting the vehicle is not allowed. Attempt to start the engine using the starting aid »» page 253.

Vehicles with a manual gearbox: In general, it is not recommended to tow start the vehicle. If the engine does not start, try the starting aid first »» page 253. Please note that, in the case of petrol engines, the maximum permitted distance for tow starting is 50 m.

- Secure the tow cable or tow bar using only the attachment points provided for this purpose.
- Switch on the ignition and the hazard warning lights.
- Engage 2nd or 3rd gear while the vehicle is stopped.
- Press the clutch and hold it down.

- When both vehicles are in motion, release the clutch pedal.
- As soon as the engine starts, depress the clutch and disengage the gear to avoid colliding with the towing vehicle.

NOTICE

When tow-starting, unburnt fuel could enter the catalytic converter and damage it.

Towing

Preliminary steps

- Secure the tow cable or tow bar using only the attachment points provided for this purpose »» ⚠. Depending on the equipment, these points may be a towing device or a towing eye.
- Make sure the tow cable is not twisted. Otherwise the towing eye could unscrew during towing.
- Switch on the ignition and the hazard warning lights of both vehicles. If necessary, take into account other different provisions that may exist in this regard.
- Take into account the instructions on towing provided in the instruction manual of the other vehicle.

Towing vehicle (lead)

- Do not actually start driving until the cable is tight.
- Accelerate with particular care.
- Avoid sharp braking and sudden manoeuvres.

Vehicles with a manual gearbox:

- When starting to drive, use the clutch very gently.

Towed vehicle (following)

- Make sure the ignition is switched on so that the steering wheel does not lock and so that, if necessary, you can use the turn signals and the windscreen wiper.
- The brake servo and power steering only work when the engine is running. Otherwise, you will have to depress the brake pedal considerably harder and more force will be needed to turn the steering wheel.
- Release the parking brake.
- Make sure the tow cable is always taut.
- Disengage the gear or place the gear selector in the **N** position.

WARNING

Never attach the tow rope or tow bar to axle or running gear components. They could be damaged, resulting in an accident and serious injury.

- Seek specialist assistance and, if applicable, have the vehicle transported on a tow truck.

NOTICE

The vehicle can only be towed if the state of charge of the 12-volt battery is sufficient to disengage the steering column lock. If the vehicle has no power supply or there is an electric system fault, the engine must be jump-started to deactivate the electronic lock of the steering column.

Front towline anchorage



Fig. 164 Front bumper on right: remove the lid.

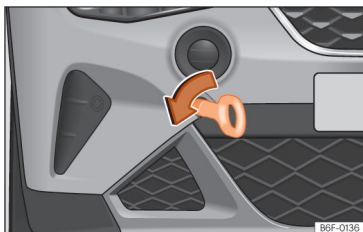


Fig. 165 Right side of the front bumper: towline anchorage screwed in.

The housing of the removable towline anchorage is on the right side of the front bumper underneath a cover >>> **Fig. 164**.

The towing eye should always be kept in the vehicle.

Bear in mind the instructions for towing >>> **page 256**.

Fitting the towline anchorage

- Remove the towing eye from the vehicle tool kit in the luggage compartment >>> **page 251**.
- Remove the cover by pressing down on its base and leave it hanging from the vehicle >>> **Fig. 164**.
- Screw the towing eye in the housing by turning it to the maximum **anticlockwise** >>> **Fig. 165**, >>> ⓪. Use a suitable object that can completely and securely tighten the towing eye in its housing.

- After towing, unscrew the towing eye **clockwise** with a suitable object.
- Replace the cover and push it in until it clicks into place.
- Clean the towing eye if necessary and then store it in the luggage compartment along with the other vehicle tools.

⚠ NOTICE

The towing eye must always be completely and firmly tightened. Otherwise, it could jump out of the housing during towing.

Rear towline anchorage

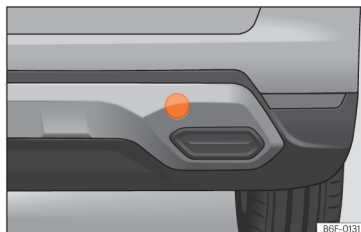


Fig. 166 Rear bumper on right: remove the lid.

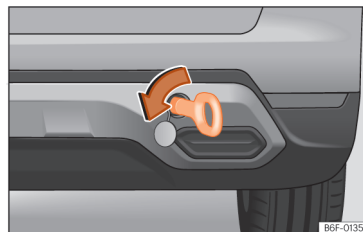


Fig. 167 Right side of the rear bumper: towline anchorage screwed in.

The housing of the screw towing eye is on the right side of the rear bumper behind a lid >>> **Fig. 166**.

Vehicles fitted as standard with a towing bracket **do not** have any housing for the screw towing eye behind the lid. In this case, the tow hitch needs to be extracted or installed and used for towing >>> **page 232**, >>> ⓪.

Bear in mind the instructions for towing >>> **page 256**.

Fitting the rear towline anchorage

- Remove the towing eye from the vehicle tool kit in the luggage compartment >>> **page 251**.
- Press the right hand side of the cover >>> **Fig. 166** to unclip it.
- Remove the lid and let it hang from the vehicle

- Screw the towing eye in the housing by turning it to the maximum **anticlockwise** »» Fig. 167 , »» page 259. Use a suitable object that can completely and securely tighten the towing eye in its housing.
- After towing, unscrew the towing eye **clockwise** with a suitable object.
- Clean the towing eye if necessary and then store it in the luggage compartment along with the other vehicle tools.

! NOTICE

- The towing eye must always be completely and firmly tightened. Otherwise, it could be released while towing and tow-starting.
- If the vehicle is factory-equipped with a towing bracket, it is only allowed to tow with a tow bar if this has been specially designed to be installed with a tow hitch. If an unsuitable tow bar is used, both the tow hitch and the vehicle may be damaged. Instead, a tow rope should be used.

Fuses

Introduction

In general, a fuse can be assigned to various electrical components. Likewise, an electrical component can be protected by several fuses.

Only replace fuses when the cause of the problem has been solved. If a newly inserted fuse blows after a short time, you must have the electrical system checked by a specialised workshop as soon as possible.

⚠ WARNING

The high voltages in the electrical system can give serious electrical shocks, causing burns and even death!

- Never touch the electrical wiring of the ignition system.
- Take care not to cause short circuits in the electrical system.

⚠ WARNING

Using unsuitable fuses, repairing fuses or fitting jumpers on a live circuit without fuses can cause a fire and serious injury.

- Never use a fuse with a higher value. Only replace fuses with a fuse of the same amperage (same colour and markings) and size.
- Never replace a fuse with a metal strip, staple or similar.

! NOTICE

- To prevent damage to the vehicle's electrical system, before replacing a fuse always turn off the ignition, the lights and all electrical components.
- Protect the fuse boxes when open to prevent the entry of dust or humidity as they can damage the electrical system.

i Note

In the vehicle, there are more fuses than those indicated in this chapter. These should only be replaced by a specialist workshop.

Fuses inside the vehicle

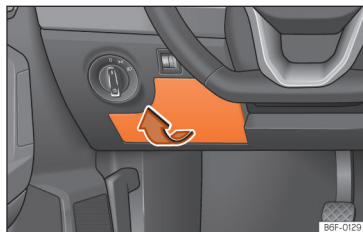


Fig. 168 On the dashboard on the driver side: lid of the fuse box.

Opening and closing the fuse box located below the instrument panel

- **Open:** remove the fuse box cover in the direction indicated >>> **Fig. 168**.
- **Close:** click the cover back into place.

Identifying fuses below the dashboard by colours

Colour	Current intensity in amps
Light brown	5
Brown	7.5
Red	10
Blue	15
Yellow	20
White or transparent	25
Green	30
Orange	40
Red	50

NOTICE

- Always carefully remove the fuse box covers and refit them correctly to avoid problems with your vehicle.
- Protect the fuse boxes when open to avoid the entry of dust or humidity. Dirt and humidity inside fuse boxes can cause damage to the electrical system.

Fuses in the engine compartment

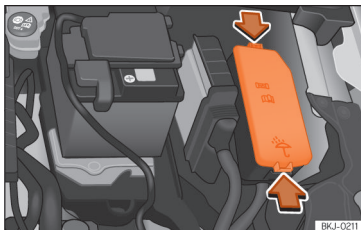


Fig. 169 In the engine compartment: lid of the fuse box.

To open the engine compartment fuse box

- Raise the bonnet >>> **△ on page 267**.
- Press the locking tabs to unlock the fuse box cover >>> **Fig. 169**.
- Then lift the cover out.

- To **fit** the cover, place it on the fuse box. Push the locking tabs down until they click audibly into place.

Replace a blown fuse

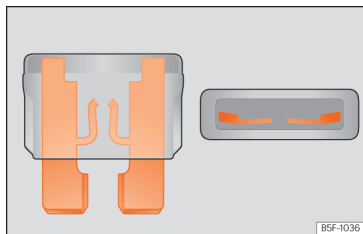


Fig. 170 Image of a blown fuse.

Preparations

- Switch off the ignition, lights and all electrical equipment.
- Open the corresponding fuse box >>> **page 259**, >>> **page 260**.

Recognise a blown fuse

A blown fuse can be recognised if the metal strip is melted >>> **Fig. 170**.

- Point a torch at the fuse to see if it has blown.

To replace a fuse

- Remove the fuse.
- Replace the blown fuse with one with an *identical* amperage rating (same colour and markings) and *identical* size.
- Replace the cover again or close the fuse box lid.

Fuse placement

Only replace fuses with a fuse of the same amperage (same colour and markings) and size.

Fuses in the vehicle interior

No.	Consumers/Amps	
1	Tow hook	20
3	Sound amplifier	30
4	Cigarette lighter/12V power point	20
6	Central locking	40
8	Heating fan/Climatronic	30
10	Tow hook	25
13	Lights switch, steering column LSS and SMLS, diagnostic port, rain/light sensor	7.5
14	Steering Column LSS: wiper control	10
15	Kombi, Emergency call (+NZ4)	7.5
16	Right lights power supply	40

No.	Consumers/Amps	
17	Right Door Window Control	30
18	Windscreen wipers	30
19	Radio, Multimedia System	25
20	Heated rear window	30
21	SCR Control Unit	30
23	Rear View Camera	7.5
24	Connectivity Box, external audio source wiring (Double USB), MIB display	5
25	Steering column electronics (MFL)	7.5
26	Gateway	7.5
27	Active suspension control unit	7.5
28	DWA Sensor	7.5
29	DWA Horn	7.5
31	9AA/9AB climate control unit	7.5
	9AK Climatronic control unit	15
32	Steering Column LSS, without Kessy	7.5
33	Left Door Window Control	30
35	Left lights power supply	40
36	Signal Horn	20
37	Heated seats control unit	30
38	BCM Power C63	30

No.	Consumers/Amps	
39	BSD, PDC, MRR, PLA	10
40	Light switch, diagnosis input, headlamp range regulator, LSS steering column: lamps, halogen lamps, switch, reverse gear, electrochromic mirror, RKA without radio.	7.5
41	Regulation of unfolded exterior mirrors	7.5
42	Clutch pedal, ignition relays, AA pressure sensor	7.5
43	DWP relay coil, rear window wiper motor	15
44	Airbag	7.5
45	Left full LED headlight	7.5
46	Right full LED headlight	7.5
48	Steering column lock, Kessy Control Unit	7.5
49	SCR relay	7.5
53	Automatic gearbox lever, ZSS	7.5
58	Windscreen washer pump	7.5
59	Heated interior mirrors	10
60	Tow hook	30
61	Tow hook	30

Fuse arrangement in engine compartment

No.	Consumer/Amps	
1	MPI Engine Injection Module	10
	TSI Engine Injection Module	15
2	Fuel metering valve (TJ4/T6P/N09), Low temperature coolant pump (TJ4/T6P/N09/TC5); Oil pressure regulating valve (TJ1), AGR coolant valve (TJ1), High and low pressure water pumps (TJ1), SCR relay coil, cylinder head water valve	7.5
	Lambda probes	15
4	Engine petrol pump relay (MPI), Gauge control unit (TSI)	15
	Electric fan (EC), LDR valve, canister and variable distribution valve, oil pressure regulating valve, cylinder disconnection valves, WIV sensor	10
6	Spark plugs (MPI and TSI)	20
7	Vacuum pump (TSI)	15
8	Injectors and EKP relay coil (MPI)	10
9	Servo sensor	7.5
10	Vref Battery: Gateway, BDM and BCM	7.5
12	Detachable compressor	10

No.	Consumer/Amps	
14	ESC, Relay 87 coil and engine controller of engines (+ TJ1 / TJ4 / TH4 / T51 / T6P / N09 / TC5 / T5Y).	7.5
	Automatic gearbox DQ200 and AQ160	30
17	50 Diag	7.5
18	BDM starter motor	30
20	ESC (Pump)	60
	ABS (Pump)	40
21	ESC/ABS (Valves)	25
24	TH4 Electric fan without A/C for moderate climate countries	30
25	TH4 fan with A/C or T51 for moderate climate countries	20
	PTC1	40
26	TJ1/TJ4/N09/T6P or TH4/T51 Electric fan for warm climate countries	50
27	TH4 fan with A/C or T51 for moderate climate countries	30
	PTC2	40
28	PTC3	40



Note

- In the vehicle, there are more fuses than those indicated in this chapter. These should only be changed by a specialised workshop.
- Positions not containing a fuse do not appear in the tables.
- Some of the equipment listed in the tables pertain only to certain versions of the model or are optional extras.
- Please note that the above lists, while correct at the time of printing, are subject to change.

Changing bulbs

Introduction

Changing bulbs requires a certain degree of practical skill. If you are unsure, SEAT recommends that you consult a technical service or request assistance from a specialist. In general a specialist is needed if, in addition to the bulbs, other vehicle components require removal.

Always use identical bulbs with the same designation. The name can be found on the base of the bulb holder.

Depending on how equipped the vehicle is, there are different sets of headlights and tail lights:

- ECOLED (full-LED) main headlights
- High (full-LED) main headlights

- Rear bulb light
- LED rear light

LED technology lights

Full-LED headlights handle all light functions (daylight, side light, turn signal, dipped beam and full beam) with light emitting diodes (LEDs) as a light source. They have been designed to last the lifetime of the vehicle and the bulbs cannot be replaced. In case of headlight failure, go to an authorised workshop to have it replaced.

The fog lights, number plate light, side turn signals and additional brake light are all LED bulbs. With this in mind, they should be replaced by a technical service.

Bulbs (12 V)

Depending on the level of equipment fitted in the vehicle, LEDs may be used for part or all of the interior and/or exterior lighting. LEDs have an estimated life that exceeds that of the vehicle. If an LED light fails, go to an authorised workshop for its replacement.

Light source used for each function

Bulb light ^{a)}	Left	Right
Brake lights	2 x P21WLL	2 x P21WLL
Side lights		
Rear fog light	P21 WLL	—

Bulb light ^{a)}	Left	Right
Reverse light	—	P21 WLL
Turn signal	PY 21W NA LL	PY 21W NA LL

^{a)} The table corresponds to a right-hand drive vehicle. The position of lights may vary according to the country.

Light with LEDs ^{a)}	Left	Right
Brake lights	LED	LED
Side lights	LED	LED
Rear fog light	LED	—
Reverse light	—	P21 WLL
Turn signal	PY 21W NA LL	PY 21W NA LL

^{a)} The table corresponds to a right-hand drive vehicle. The position of lights may vary according to the country.

WARNING

- Bulbs are highly sensitive to pressure. The glass can break when you touch the bulb, causing injury.
- When changing the bulbs, take care not to injure yourself on parts with sharp edges.

NOTICE

- Remove the ignition key before working on the electric system. Otherwise, a short circuit could occur.
- Switch off the lights and the parking light before changing a bulb.
- Take good care to avoid damaging any components.

For the sake of the environment

Please ask your specialist retailer how to dispose of used bulbs in the proper manner.

Note

- Depending on weather conditions (cold or wet), the front lights, the fog lights, the tail lights and the turn signals may be temporarily misted. This has no influence on the useful life of the lighting system. By switching on the lights, the area through which the beam of light is projected will quickly be demisted. However, the edges may continue to be misted.
- Please check at regular intervals that all lighting (especially the exterior lighting) on your vehicle is functioning properly. This is not only in the interest of your own safety, but also that of all other road users.
- Before changing a bulb, make sure you have the correct new bulb.

- Do not touch the glass part of the bulb with your bare hands, use a cloth or paper towel instead, since the fingerprints left on the glass will vaporise as a result of the heat generated by the bulb, they will be deposited on the reflector and will alter its surface.
- Depending on the level of equipment fitted in the vehicle, LEDs may be used for part or all of the interior and/or exterior lighting. LEDs have an estimated life that exceeds that of the car. If an LED light fails, go to an authorised workshop for its replacement.

Changing bulbs

Tail light bulbs located in the bodywork

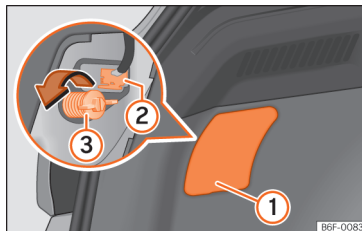


Fig. 171 Luggage compartment: access to the bolt securing the tail light unit.

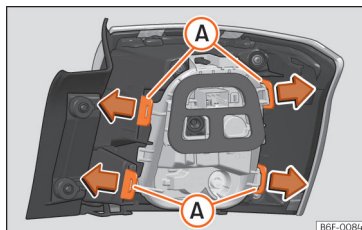


Fig. 172 Retaining tabs on the reverse side of the tail light.

Follow the steps indicated:

- Check which of the bulbs is defective.
- Open the rear lid.

- Remove the lid by levering the flat side of a screwdriver into the recess »» **Fig. 171** ①.
- Remove the bulb connector ②.
- Unscrew the bolt securing the light ③ by hand or using a screwdriver.
- Remove the light from the body by gently pulling it toward you, and place on a clean, smooth surface.
- Remove the bulb holder by unlocking the retaining tabs »» **Fig. 172** A.
- Change the damaged bulb.
- To refit follow the steps in reverse order, taking special care when fitting the bulb holder. The securing tabs must click into place.

⚠ NOTICE

Take care when removing the rear light unit to make sure there is no damage to the paintwork or any of its components.

i Note

- Make sure you have a soft cloth ready to place under the glass on the rear light unit, to avoid any scratches.
- For LED lights, you can only change the turn signal and reverse light bulbs.

Tail lights bulbs located in the rear lid

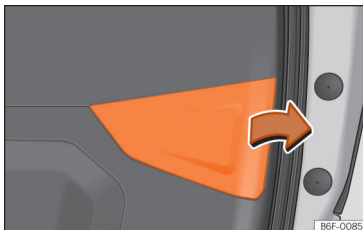


Fig. 173 Rear lid open: remove the lid.

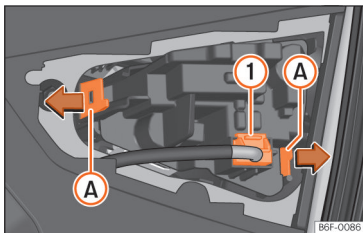


Fig. 174 Remove the bulb holder.

Follow the steps indicated:

- Check which of the bulbs is defective.
- Open the rear lid.
- Remove the rear lid cover in the direction of the arrow >>> **Fig. 173**.
- Remove the bulb connector >>> **Fig. 174** ①.

- Remove the bulb holder by unlocking the retaining tabs **A**.
- Change the damaged bulb.
- Use a cloth to remove any fingerprints from the glass part of the bulb.
- Check that the new bulb works properly.
- Carry out the same actions in reverse order for assembly and pay special attention to placing the bulb holder, ensuring that the tabs are properly secured.

i Note

For LED lights, you can only change the turn signal and reverse light bulbs.

Changing interior bulbs

Interior light and front reading lights

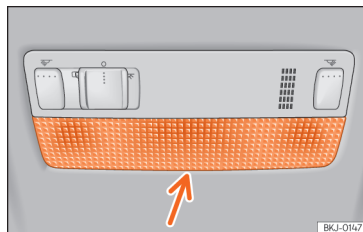


Fig. 175 Front reading light.

- Insert a thin screwdriver between the casing and the glass >>> **Fig. 175**.
- Carefully remove the glass, levering it to avoid possible damage.
- Pull the bulbs outwards.
- To remove the central bulb, hold and press to one side.
- Proceed in the reverse order, pressing gently on the outer edge of the side light.
- First fit the glass with the fastening tabs over the frame of the switch. Next press the front part until the two long tabs click on the support.

i Note

In LED courtesy lights it is not possible to replace the light sources. If the light does not work, take the vehicle to an official Service.

Luggage compartment lighting

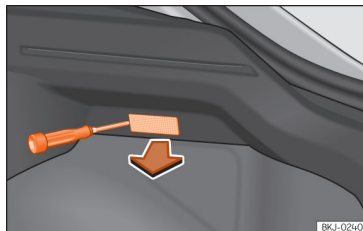


Fig. 176 Luggage compartment lighting.

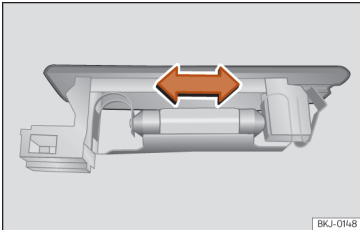


Fig. 177 Luggage compartment lighting.

- Extract the bulb by pressing on its inside edge using the flat side of a screwdriver »» **Fig. 176**.
- Disconnect the cable.
- Press the bulb sideways and remove it from its housing »» **Fig. 177**.
- Change the bulb.
- Reconnect the cable.
- Refit the bulb and press it in until it engages.

Checking and refilling levels

Engine compartment

Working in the engine compartment

The engine compartment of the vehicle is a dangerous area. You should only perform works in the engine compartment if you have good knowledge of the necessary operations and the general safety measures, and if you have adequate tools, means and operating fluids. Works performed inadequately could lead to serious injuries »» » ⚠. In this case, get a specialised workshop to perform all the works. SEAT recommends visiting a SEAT dealership for this.

Before performing any work in the engine compartment, always park the vehicle on level and firm ground, taking all necessary safety precautions.

⚠ WARNING

Any accidental movement of the vehicle during maintenance work could cause serious injuries.

- Never perform works underneath the vehicle without having first immobilised it to prevent it from moving. When working under the vehicle with the wheels on the ground, the vehicle must be on a level surface and the wheels must be locked.
- If work must be performed underneath the vehicle, take the extra precaution of supporting it safely using a suitable support assembly. The jack is not suitable for this purpose and may not provide support, which could lead to serious injuries.
- The Start-Stop system must be switched off manually.

⚠ WARNING

The engine compartment of any vehicle is a dangerous area in which serious injuries can be caused!

- When performing any type of work, always ensure you are extremely cautious, and bear in mind the general safety measures. Never put yourself at risk.
- Never perform works in the engine compartment if you do not have solid knowledge of the necessary operations. If you are unsure of what needs to be done, seek a speci-

alised workshop to perform the works. Works performed inadequately could lead to serious injuries.

- Never open or close the bonnet if you see steam or coolant escaping from the engine compartment. Steam or hot coolant can cause severe burns. Always wait until you stop hearing or seeing the steam or coolant discharging from the engine compartment.
- Before opening the bonnet, always wait for the engine to cool down.
- Touching hot engine or exhaust system components could result in skin burns.
- Turn off the ignition and keep the vehicle key in a safe place at a safe distance from the vehicle to prevent the ignition from being turned on and the combustion engine started by mistake.
- Always keep children away from the engine compartment and never leave them unsupervised.
- When the engine is hot, its cooling system is pressurised. Do not open the expansion tank cap. Hot coolant may splash out and cause severe burns and other injuries.
 - Turn the coolant expansion tank cap slowly and very carefully anticlockwise while pressing it down slightly.
 - Always protect your face, hands and arms from the hot coolant and steam with a large thick cloth.

- When refilling operating fluids, ensure they do not spill onto the components of the engine or onto the exhaust system. These liquids could cause a fire.

WARNING

The electrical system is under high voltage and can cause electrical shocks, burns, serious injuries and even death!

- Never short circuit the electrical system. The 12-volt battery could explode.
- To reduce the risk of electric shock and serious injury, never touch the electrical wires of the ignition system while the engine is running or when starting.

WARNING

There are rotating parts in the engine compartment which could cause serious injury.

- Never insert your hand into the radiator fan or around that area. All the rotor blades can cause serious injuries. The fan activates depending on the temperature and can switch on automatically, even if the ignition is off.
- If any work has to be done during engine start-up or when it is running, take into account that the rotating parts (e.g. the poly-V belt, alternator and the radiator fan) and the high-voltage ignition system pose a fatal hazard. Always act with extreme care.

- Ensure that no part of your body, or any jewellery or tie, loose clothing, loose long hair can become trapped in the rotating parts. Before performing works in the engine compartment, remove any jewellery or tie you may be wearing, tie up your hair if it is long and gather any loose clothing.
- Do not press the accelerator pedal while not paying attention. Always do so with extreme care. The vehicle may start to move even when the parking brake is applied.
- Do not leave objects in the engine compartment, e.g. rags or tools.

WARNING

The operating fluids and some materials of the engine compartment are highly flammable and could cause a fire and serious injuries!

- Never smoke in the vicinity of the engine compartment.
- Never perform works close to unprotected flames or sparks.
- When you must perform works on the on-board 12 volt electrical system, bear in mind the following:

- Always disconnect the 12 volt battery. Ensure the vehicle is unlocked when disconnecting the 12-volt battery, otherwise the anti-theft alarm will trigger.
- Never perform works in the vicinity of heating elements, water boilers or unprotected flames.
- Always have a fire extinguisher close-by. Make sure it is operational and has been inspected.

NOTICE

When refilling or changing the operating fluids, ensure you pour the correct fluids into their corresponding filler caps. Using the wrong operating fluids can lead to serious malfunctions and engine damage.

For the sake of the environment

Operating fluids that overflow from the vehicle contaminate the environment. Therefore, check underneath the vehicle on a regular basis. If there are marks on the ground left by operating fluids, consult a specialised workshop and request the vehicle be checked. If any operating fluid leaks out, dispose of it in the correct manner.

Preparing the vehicle for work in the engine compartment

Before performing works in the engine compartment, always perform the following operations in the order indicated >>> ⚠:

1. Place the vehicle on level and firm ground, taking all necessary safety precautions.
2. Press the brake pedal and hold it down until the ignition is switched off.
3. Apply the parking brake.
4. *Manual transmission:* place the gear lever in neutral.
Automatic transmission: move the selector lever to position **P**.
5. Switch the ignition off >>> **page 114**.
6. Remove the vehicle key from the vehicle and store it outside to avoid inadvertently starting the engine.
7. Wait for the engine to cool down sufficiently.
8. Always keep other people away from the engine compartment.
9. Immobilize the vehicle so that it cannot move.

⚠ WARNING

For your own safety, do not ignore this important check list, otherwise accidents and serious injuries could be caused.

- Always follow the indications on the check list and always bear in mind the general safety measures.

Opening and closing the bonnet

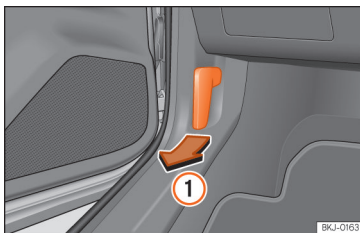


Fig. 178 Release lever in the driver's footwell area.

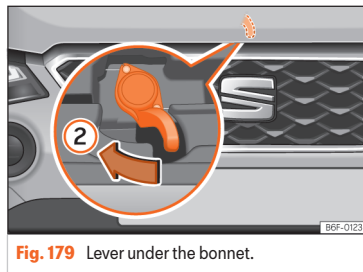


Fig. 179 Lever under the bonnet.

Opening the bonnet

The bonnet is released from inside the vehicle. Before opening the bonnet, make sure that the windscreen wiper arms are in place against the windscreen.

- Open the door and pull the lever that is underneath the instrument panel >>> **Fig. 178 ①**.
- To lift the bonnet, press towards the left on the lever located under the bonnet, in the centre >>> **Fig. 179 ②**. The fastening hooks are unlocked.
- The bonnet can be opened. Release the bonnet stay and secure it in the fixture designed for this in the bonnet.

Closing the bonnet

- Slightly lift the bonnet.
- Release the bonnet stay and replace it in its support.
- At a height of approximately 20 cm let it fall so it locks.

If the bonnet does not close, do not press downwards. Open it again and let it fall as mentioned above.

WARNING

Make sure that the bonnet is properly closed. If it opens when driving, it can cause an accident.

NOTICE

In certain weather conditions, ice or snow may build up between the bonnet and windscreen; do not force the bonnet open until you are sure that there is no ice or snow, especially in the hinge area.

NOTICE

To avoid damage to the bonnet and to the windscreen wiper arms, only open it when the windscreen wipers are in place against the windscreen.

Fluids and consumables

Introduction

All fluids and consumables, such as engine coolant or vehicle batteries, are subject to continuous development. For this reason, whenever a fluid or consumable needs to be replaced, please contact a specialist workshop.

SEAT dealers always promptly receive information about any modifications.

WARNING

If unsuitable fluids and consumables are used or used improperly, accidents, injuries, burns and severe poisoning can occur.

- Only store operating fluids in their original containers, tightly closed.
- Never store operating fluids in empty food cans, bottles or other empty containers, as they could be ingested by somebody.
- Keep all fluids and consumables out of reach of children.
- Always read and observe the information and warnings given on containers of operating fluids.
- When using products that emit harmful vapours, always work outdoors or in a well-ventilated area.

NOTICE

Use only appropriate operating fluids. Never confuse operating fluids. This could result in serious malfunctions and engine damage!

For the sake of the environment

Leakages of operating fluids can contaminate the environment. If any operating fluid leaks, collect it in an appropriate container and dispose of it properly and in an environmentally friendly manner.

Cooling system

Introduction

Only carry out work on the engine cooling system yourself if you are familiar with the necessary operations and the generally applicable safety measures, and if you have the appropriate tools, equipment and operating fluids. Works performed inadequately could lead to serious injuries. In this case, get a specialised workshop to perform all the works. SEAT recommends visiting a SEAT dealership for this.

⚠ WARNING

Engine coolant is toxic!

- Only store coolant in its original container, tightly closed and in a safe place.
- Never store motor coolant in empty food cans, bottles or other empty containers, as it could be ingested by another person.
- Always keep motor coolant out of reach of children.
- Ensure that the coolant fluid additive percentage is correct, taking into account the lowest ambient temperature expected in the location where the vehicle is to be used.
- When the outside temperature is very low, the coolant could freeze and the vehicle could be immobilised. In this case, the heating would not work either and inadequately dressed passengers could die of cold.

🌿 For the sake of the environment

Coolants and additives can contaminate the environment. If any operating fluid leaks out, collect it and dispose of it properly and in an environmentally friendly manner.

Coolant specifications

The factory fitted engine cooling system is filled with a mixture of specially treated water and at least 40% coolant additive G12evo (TL-VW 774 L).

Get information from a specialist workshop about which coolant is suitable for your vehicle. SEAT recommends visiting a SEAT dealership for this.

To protect the engine cooling system, the additive percentage should **always** be at least 40%. If more antifreeze protection is required for climatic reasons, the additive proportion can be increased. However, it should only be increased up to a maximum of 55%, otherwise the antifreeze protection would be reduced and the cooling effect would be impaired.

The G12evo (TL-VW 774 L) can be recognised by its lilac colouring. This mixture of water and additive not only provides antifreeze protection down to -25°C (-13°F), but also protects the light alloy parts of the cooling system against corrosion, prevents limescale build-up and considerably raises the boiling point of the coolant.

When topping up the coolant, a mixture of **distilled water** and at least 40% of the appropriate coolant additive should be used for optimum corrosion protection »» page 272.

⚠ WARNING

If the vehicle's cooling system does not have sufficient antifreeze protection, the engine could fail and this could result in serious injury.

- Ensure that the coolant fluid additive percentage is correct, taking into account the lowest ambient temperature expected in the location where the vehicle is to be used.
- When the outside temperature is very low, the coolant could freeze and the vehicle could be immobilised. In this case, the heating would not work either and inadequately dressed passengers could die of cold.

ⓘ NOTICE

Never mix the original additives for the G12evo coolant (TL-VW 774 L) with motor coolant fluid not authorised by SEAT.

- If the fluid in the expansion tank does not have a pink colour (resulting from mixing the lilac additive with distilled water), but is, for example, brown, the suitable coolant may have been mixed with another unsuitable one. The coolant must be changed as soon as possible if this is the case! Otherwise serious malfunctions or damage to the engine and the cooling system could occur!

For the sake of the environment

Motor coolant and its additives can pollute the environment. If any operating fluid leaks out, collect it and dispose of it properly and in an environmentally friendly manner.

Check and refill the coolant

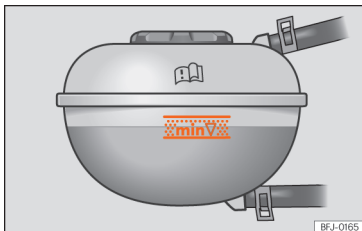




Fig. 180 In the front compartment: marking on coolant expansion tank.



Fig. 181 Front compartment: coolant expansion tank cap.

Preliminary steps

- Park the vehicle on a firm, flat surface.
- Wait until the engine has fully cooled >>> .
- Open the front bonnet.
- The motor coolant expansion tank can be recognised by the symbol on the cap  >>> **Fig. 181**

Check the level

When the vehicle is delivered (new vehicles), the coolant may be above the marked area. This is normal. It is not necessary to suck the coolant out.



- When the engine is cold, check the coolant level using the side marking on the expansion tank >>> **Fig. 180**. The coolant level should be between the marks.

- If the level is below the minimum level mark (**min**) on the tank, top up with coolant. When the engine is warm, the coolant level may be slightly above the upper mark.

Topping up the fluid

When the motor coolant level is too low, the coolant warning light comes on. In this case, immediately seek assistance from specialist personnel.

If the coolant level is too low and there is no workshop nearby, note the following:

- Always protect your face, hands and arms from hot coolant or steam by placing a suitable cloth over the cap of the motor coolant expansion tank.
- Carefully unscrew the cap >>> .
- Only top up with **fresh** coolant according to SEAT specifications >>> **page 271**.
- Only top up with coolant if there is still some coolant left in the expansion tank; otherwise the engine could be damaged! If you do not see any coolant in the expansion tank, **do not continue driving** and seek specialist assistance.
- If there is still some coolant left in the expansion tank, top up with coolant up to the tank's upper mark and check the level the next day. If the level drops **again**, go to a workshop and request a check of the cooling system.
- The coolant level must be between the marks on the expansion tank >>> **Fig. 180**. **Never exceed the top edge of the marked area** >>> .

- Screw the cap on tightly.
- If engine coolant with the recommended specifications is not available in an emergency, do not use any other coolant additive! In this case, top up with **distilled water** >>> ⓘ only. Next, ensure that the recommended additive is topped up as soon as possible in the correct proportion >>> page 271.

⚠ WARNING

Steam and hot engine coolant can cause severe burns.

- Never open the front bonnet if you see or hear steam or coolant escaping from the front compartment. Always wait until you can no longer see or hear steam or coolant escaping. Touching hot parts can result in skin burns.
- Before opening the front bonnet, please note the following:
 - Apply the parking brake.
 - Always keep children away from the front compartment and never leave them unattended.

- When the engine is hot, its cooling system is pressurised. Do not open the expansion tank cap. Hot coolant may splash out and cause severe burns and other injuries.

- Turn the cap slowly and very carefully anticlockwise while pressing it down slightly.
- Always protect your face, hands and arms from the hot coolant and steam with a large thick cloth.

ⓘ NOTICE

Only use distilled water! Other types of water contain chemical substances that could cause significant corrosion damage. If you have added non-distilled water, have all of the engine cooling system fluid changed immediately by a specialist workshop.

- When topping up the, do not fill over the upper edge of the marked area >>> Fig. 180. Otherwise, when the temperature rises the excess fluid will be expelled from the engine cooling system and could cause damage.
- If the system leaks a lot of coolant, only refill once the motor has cooled down completely. If there is a significant loss of coolant, there may be leaks in the cooling system. Immediately go to a specialist workshop to have the system checked. This could result in engine damage.

- Do not add coolant if the expansion tank is completely empty! Air may have got into the cooling system. Do not continue driving and seek assistance from specialist personnel. This could result in engine damage.

- When changing the operating fluids, make sure that you pour the correct fluids into the correct filler necks. Using the wrong operating fluids can lead to serious malfunctions and engine damage.

Brake fluid

Check and refill the brake fluid



Fig. 182 Engine compartment: brake fluid reservoir cap.

Checking the brake fluid level


The brake fluid level must be between the **MIN** and **MAX** markings.

However, if the brake fluid level goes down noticeably in a short time, or drops below the **MIN** mark, there may be a leak in the brake system. Seek specialist assistance. A warning light on the instrument cluster display monitors the brake fluid level.

Brake fluid level

The control lamp lights up red.

Brake fluid level is too low.

-  **Stop driving!**
- Check the brake fluid level.
- If the brake fluid level is too low, seek specialist assistance.

Changing brake fluid

We recommend that you have the brake fluid changed by a Technical Service.

WARNING

If the brake fluid level is low or unsuitable/old brake fluid is used, the brake system may fail or braking power may be reduced.

- Check the brake system and the brake fluid level regularly!
- When the brake fluid is used and brakes are subjected to extreme braking forces, bubbles of vapour form in the brake system. These bubbles can significantly reduce brak-

ing power, notably increasing braking distance, and could result in the total failure of the brake system.

- Be sure to always use the correct brake fluid. Only use brake fluid that expressly meets the VW 501 14 standard.
- You can buy VW 501 14 standard brake fluid in a SEAT dealership or a SEAT Official Service. If none is available, use only high-quality brake fluid that meets DIN ISO 4925 CLASS 4 standards, or USA Standards FMVSS 116 DOT 4.
- The replacement brake fluid must be new.
- Brake fluid should be stored in the closed original container in a safe place out of reach of children. Risk of poisoning!

NOTICE

Brake fluid should not come into contact with the vehicle paintwork, as it is abrasive.

Note

Brake fluid is an environmental pollutant. Collect any spilt service fluids get a professional to dispose of them.

Windscreen washer reservoir

Checking the level of the windscreen washer reservoir and refilling it

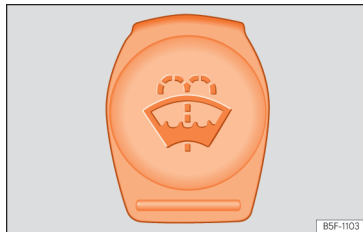




Fig. 183 In the engine compartment: blue cap of the windscreen washer reservoir.

Check the water level in the windscreen washer reservoir regularly and top up as required.

The windscreen washer reservoir contains liquid detergent for the windscreen and rear window.

There is a sieve in the filler neck of the washer fluid tank. When filling the tank, this sieve retains large dirt particles so that they do not reach the nozzles. Do not remove the sieve except for cleaning. If the sieve is damaged or not fitted, these dirt particles could enter the system during filling and clog the windscreen washer nozzles.

- Raise the bonnet >>>  on page 267.
- The windscreen washer reservoir is marked with the symbol  on the cap.
- Check if there is enough fluid in the tank.

Plain water is not enough to clean the windscreen and headlights. We recommend that you always add a product to the windscreen washer fluid.

The capacity of the windscreen washer reservoir is approximately 3 litres.

NOTICE

If the water from the windscreen washer does not contain enough antifreeze, it may freeze on the windscreen and rear window, reducing forward and rear visibility.

- In winter, ensure the windscreen washer contains enough antifreeze.
- In cold conditions, you should not use the windscreen wiper system unless you have warmed the windscreen with the ventilation system. The antifreeze could freeze on the windscreen and reduce visibility.

NOTICE

Never mix an unsuitable antifreeze or other similar additives with the windscreen washer water. A greasy layer may be formed on the windscreen which will impair visibility.

- Use clean water with a window cleaner recommended by SEAT.
- If necessary, add a suitable antifreeze to the water in the reservoir.

NOTICE

- Do not mix cleaning products recommended by SEAT with other products. This could lead to flocculation and may block the windscreen washer jets.
- When topping up service fluids, make absolutely certain that you fill the fluids into the correct reservoirs. Using the wrong fluids could cause serious malfunctions.
- Lack of window washer fluid causes the view through the windscreen to be obscured.

Engine oil

General notes

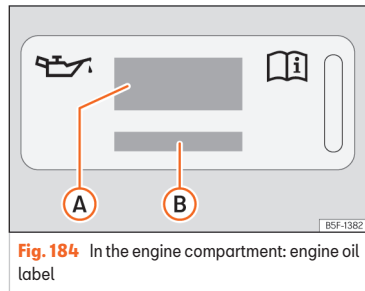


Fig. 184 In the engine compartment: engine oil label

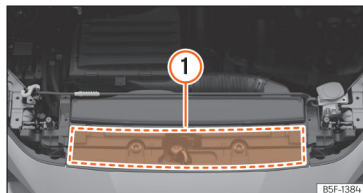




Fig. 185 In the engine compartment: area where the engine oil label is located

Key to >>> **Fig. 184:**

-  Information about the engine oil standard.
-  Information about engine oil viscosity.

The engine comes with a special, multi-grade oil that can be used all year round.

Because the use of high-quality oil is essential for the correct operation of the engine and its long useful life, when topping up or changing oil, use only those oils that comply with VW standards.

For vehicles with an engine oil label

If the engine oil has to be topped up, use one of the oils shown on the label »» **Fig. 184**. The label with the prescribed standard is located at the front of the engine compartment »» **Fig. 185** ①. If you use the recommended engine oil, you can top up the oil as often as necessary.

For vehicles without an engine oil label

Contact a specialised workshop or SEAT official service for information about the corresponding standard.

If the engine oil level is too low

If the recommended engine oil is not available, **in the event of an emergency** you can change the oil **once** with a maximum of 0.5 l of the next oil until the next oil change:

- *Petrol engines:* standard VW 504 00, ACEA C3, ACEA C4, API SN or IL-SAC GF-6A.

SEAT recommends changing the oil at a specialised workshop. SEAT recommends an Official SEAT Service.

ⓘ NOTICE

SEAT recommends the use of engine oils approved according to the appropriate VW standard. Use of engine oils that do not meet these quality requirements can cause engine damage.

SEAT recommends the use of Original SEAT Spare Part engine oils.

Engine oil additives

No type of additive should be mixed with the engine oil. The deterioration caused by these additives is not covered by the warranty.

Depending on how you drive and the conditions in which the vehicle is used, oil consumption can be up to 0.5 l/1000 km. Oil consumption is likely to be higher for the first 5,000 km. For this reason the engine oil level must be checked at regular intervals, preferably when filling the tank and before a journey.

ⓘ NOTICE

0.5 l of engine oil of one of the indicated engine oil standards may be used, only in the event of an emergency and in exceptional cases.

ⓘ NOTICE

Take the following into account if you have refilled with an engine oil different to those specified in the aforementioned standards, or by your SEAT technical service centre:

- There is no way of completely avoiding the danger of causing damage to the engine and particulate filter.
- You can continue driving with the vehicle if the refill was no more than 0.5 l of engine oil. Go to a specialised workshop as soon as possible and request an oil change. Otherwise, there is a danger of engine damage.
- If you have topped up more than 0.5 l of engine oil, drive with the engine at low load levels and within the medium RPM range as a maximum. Do not drive at more than 80 km/h and do not travel more than 300 km (approximately). Go to a specialised workshop as soon as possible and request an oil change. Otherwise, there is a danger of engine damage.
- You are responsible for the risk of possible damage to the vehicle (engine, exhaust system). If in doubt, do not start the engine and request assistance from the technical service centre.
- Do not start the engine if you have topped up with a fluid other than engine oil. Request assistance from the technical service centre. Danger of engine damage!

Note

Before a long trip, we recommend finding an engine oil that conforms to the corresponding VW specifications and recommend keeping it in the vehicle. This way, the correct engine oil will always be available for a top-up if needed.

- If the label showing the engine oil specifications is missing >>> Fig. 184, please contact a specialist workshop.

Checking and topping up the engine oil level

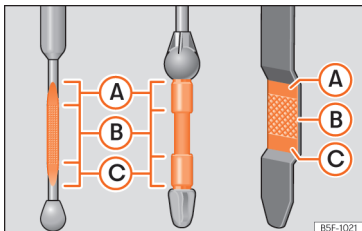


Fig. 186 Engine oil dipstick.



Fig. 187 Oil filler cap cover in the engine compartment.

Key to the >>> Fig. 186:

- Ⓐ Do not top up oil in any case.
- Ⓑ You can add oil but keep the level in that zone.
- Ⓒ The oil level is too low. Add oil up to zone Ⓑ.

Before opening the bonnet, read and observe the warnings >>> page 267, *Working in the engine compartment*.

Check the oil level


The engine oil dipstick indicates the level of the oil.

- Park the vehicle in a horizontal position.
- Briefly run the engine at idle speed until the operating temperature is reached and then stop.

- Wait for about two minutes.
- Locate the oil level dipstick. It can be recognized by its coloured upper end.
- Pull out the dipstick. Wipe the dipstick with a clean cloth and insert it again, pushing it in as far as it will go.
- Then pull it out again and check the oil level >>> Fig. 186. Top up with engine oil if necessary. The oil should leave a mark between the areas Ⓐ and Ⓑ. It must never exceed zone Ⓐ.

Depending on how you drive and the conditions in which the vehicle is used, oil consumption can be up to 0.5 l/1000 km. Oil consumption is likely to be higher for the first 5,000 km. For this reason the engine oil level must be checked at regular intervals, preferably when filling the tank and before a journey.

Topping up engine oil

- Locate the engine oil filler cap. It can be recognized by the symbol  on the cover >>> Fig. 187.
- Unscrew cap from the oil filler mouth >>> Fig. 187.
- Carefully add oil in small quantities (no more than 0.5 l).
- To avoid adding too much oil, whenever you add a certain amount, wait about 2 minutes and recheck the oil level >>> page 277.
- If necessary, add some more oil.

- When the oil level reaches at least zone **>>> Fig. 186 (B)**, carefully screw on the engine oil filler cap **>>> ①**.

Engine oil specification **>>> page 275.**

⚠ WARNING

Any work carried out in the engine compartment or on the engine must be carried out cautiously.

- When working in the engine compartment, always observe the safety warnings **>>> page 267.**

⚠ WARNING

Oil is highly inflammable! Ensure that no oil comes into contact with hot engine components when topping up.

ⓘ NOTICE

If the oil level is above zone **(A)**, do not start the engine. This could result in damage to the engine and catalytic converter. Contact a Technical Service.

🌿 For the sake of the environment

Under no circumstances should the oil level be above zone **(A)**. Otherwise oil can be drawn in through the crankcase breather and leak into the atmosphere via the exhaust system.

ⓘ Note

Before a long trip, we recommend finding an engine oil that conforms to the corresponding VW specifications and recommend keeping it in the vehicle. This way, the correct engine oil will always be available for a top-up if needed.

Engine oil change

We recommend that you have the engine oil changed by a Technical Service.

⚠ WARNING

Only change the engine oil yourself if you have the specialist knowledge required!

- Before opening the bonnet, read and observe the warnings **>>> page 267.**
- Wait for the engine to cool down. Hot oil may cause burn injuries.
- Wear eye protection to avoid injuries, such as acid burns, caused by splashes of oil.
- When removing the oil drain plug with your fingers, keep your arm horizontal to help prevent oil from running down your arm.
- Wash your skin thoroughly if it comes into contact with engine oil.
- Engine oil is poisonous! Used oil must be stored in a safe place out of the reach of children.

ⓘ NOTICE

No additives should be used with engine oil. This could result in engine damage. Any damage caused by the use of such additives would not be covered by the factory warranty.

🌿 For the sake of the environment

- We recommend that you change the engine oil and the filter at a technical service centre.
- Never pour oil down drains or into the ground.
- Use a suitable container when draining the used oil. It must be large enough to hold all the engine oil.


Troubleshooting

🔧 Engine oil pressure too low

The indicator lamp lights up red.

🚫 Do not carry on driving! Switch off the engine. Check the engine oil level.

- If this warning lamp **🔧** starts to flash, and is accompanied by **three audible warnings**, switch off the engine and check the oil level. If necessary, add more oil **>>> page 277.**

- If the warning lamp  flashes although the oil level is correct, **stop driving**. Do not even run the engine at idle speed! Seek professional assistance.

Engine oil level too low

The indicator lamp lights up yellow.

- Check the engine oil level as soon as possible **>>> page 277**.
- Change the oil as soon as you have the opportunity to do so.

Oil level sensor fault

The control lamp flashes yellow.

- Have the check done by a specialised workshop.
- Until then it is advisable to check the oil level every time you refuel.

12-volt battery

Introduction

The 12 volt battery is located in the engine compartment. Its status is checked and, if necessary, it is replaced as part of maintenance work.

All work on batteries requires specialist knowledge. Please refer to a SEAT Official Service or a workshop specialising in batteries: risk of burns or exploding battery!

The battery must not be opened! Never try to change the fluid level of the battery. Otherwise explosive gas is released from the battery that could cause an explosion.

Battery warning indications



Wear protective goggles.



Battery acid is extremely corrosive. Wear protective gloves and eye protection. Rinse any splashes of electrolyte with plenty of water.



Fires, sparks, open flames and smoking are prohibited.



The battery should only be charged in a well-ventilated zone. Risk of explosion!



Keep children away from acid and the battery.



Always follow the instruction manual.

If the vehicle is not used for long periods

The vehicle has a system for monitoring the current consumption when the engine is left unused for extended periods of time **>>> page 282**. Some functions, such as the interior lights, or the remote door opening, may be temporarily disabled to prevent the battery from running flat. These functions will come back on as soon as the ignition is switched on and the engine started.



WARNING

Working on the 12-volt battery and electrical system can cause severe burns, fire and electric shock. Always read and observe the following warnings and safety precautions before working on the battery:

- Before working on the 12-volt battery, switch off the ignition and all electrical consumers and disconnect the negative cable from this battery.
- Always keep children away from the 12-volt battery electrolyte and the battery itself.
- Always wear eye protection and protective gloves.
- The battery electrolyte is very corrosive It can cause skin burns and blindness. When handling the 12-volt battery, protect your hands, arms and face in particular from acid splashes
- Do not smoke while working and never work in the vicinity of naked flames or sparks.
- Avoid sparks caused by electrostatic discharges, just like when handling electric cables and devices.
- Never short the battery terminals.
- Never use damaged 12-volt batteries. They could explode. If the 12-volt battery is damaged, replace it immediately.
- Never use a frozen 12 volt battery. When the battery is discharged, it may freeze at temperatures close to 0°C (+32 °F). If the 12-volt battery is frozen, replace it immediately.

NOTICE

Do not expose the 12-volt battery to direct sunlight for a prolonged period of time.

- Ultraviolet rays can damage the battery casing.

NOTICE

If the vehicle is not to be used for a long period of time, protect the 12-volt battery from frost.

- The battery may freeze and, as a result, suffer irreparable damage.

Note

After starting the engine with a deeply discharged or newly replaced 12-volt battery, or after a jump start, some system settings (time, date, personalised comfort settings and programs) may be incorrectly set or deleted. Check and correct these settings once the battery is sufficiently charged.

Note

During the winter, the starting power may be reduced, and if necessary, the battery should be charged.

Check the electrolyte level

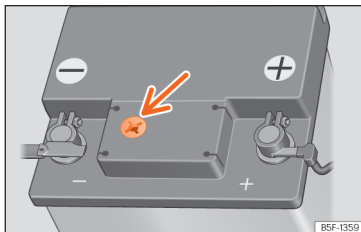


Fig. 188 Sight glass on the top of the 12-volt battery (schematic representation).

Battery access

The 12-volt battery is located in the engine compartment.

- Raise the bonnet >>> in *Working in the engine compartment* on page 267.
- Lift the cover that protects the front of the battery.

Check the level

The electrolyte level should be checked regularly in high-mileage vehicles, in hot countries and in older batteries.

- Check the colour display in the sight glass on the top of the battery >>> **Fig. 188**.
- If there are air bubbles in the window, tap the window gently until they disperse.

The “magic eye” indicator, located on the top of the battery changes colour, depending on the charge state and electrolyte level of the battery.

There are two different colours:

Yellow or colourless: The battery’s electrolyte level is too low. Go to a specialised workshop to have the battery checked and replaced if necessary.

Black: The battery’s electrolyte level is correct.

Charging, replacing, disconnecting and connecting the 12-volt battery

If you suspect that the 12-volt battery is damaged or defective, have it checked by a qualified specialist workshop.

Charging the 12-volt battery

Contact a specialist workshop for charging the 12-volt battery, as the battery model fitted in the vehicle in the factory uses a technology that requires limited voltage charging >>> . SEAT recommends visiting a SEAT dealership for this.

Replacing the 12-volt battery

The 12-volt vehicle battery has been designed to suit its location and has special safety features. If a 12-volt battery needs to be replaced, the replacement battery must be installed by a qualified technician. SEAT recommends visit-

ing a SEAT dealership. Component information regarding size, maintenance, power and safety characteristics to be met can be obtained from a qualified technician, who should have the necessary documentation and technical equipment. SEAT recommends visiting a SEAT dealership.

The degassing hole of the 12-volt battery must always be on side of the negative pole. The degassing hole on the side of the positive pole must always be sealed.

Only use maintenance-free 12-volt batteries that comply with the TL 825 06 and VW 7 50 73 standards. These standards must be dated October 2014 or later.

The 12-volt battery must always be replaced by a qualified technician, as the vehicle's electronic system must also be adjusted as part of the replacement. In addition, the battery parameters relating to operational safety can only be determined with the original battery. Only a qualified technician has both access to the right technology to make the adjustment and the correct replacement batteries.


NOTICE

The use of batteries that do not meet SEAT's quality specifications, or with a capacity lower than that fitted as standard, could, depending on the local legislation in each country, lead to the loss of approval or the corresponding administrative permits for the vehicle. In addition, it may pose a serious safety risk.


Vehicles with Start-Stop functions (**>>> page 118**) are fitted with a special battery. Therefore, it must only be replaced with a battery of the same specifications.

Disconnecting the 12-volt battery

If the 12-volt battery is to be disconnected from the vehicle's electrical system, please note the following:

- Switch off all electrical consumers.
- Before disconnecting the battery, unlock the vehicle, otherwise the alarm will be triggered.
- First disconnect the negative cable and then the positive cable **>>> **.

Connecting the 12-volt battery

- Switch off all electrical consumers before reconnecting the 12-volt battery.
- First reconnect the positive cable and then the negative one **>>> **.

After connecting the 12-volt battery and switching on the ignition, several control lamps may light up. These lamps go out after a short distance at a speed of approx. 15 to 20 km/h (10 to 12 mph). If the warning lights do not go out, visit a specialist workshop and have the vehicle checked.

If the 12-volt battery has been disconnected for a long period of time, it is likely that the next service will not be correctly indicated or

calculated **>>> page 16** . In this case it will be necessary to take into account the maximum permitted maintenance intervals **>>> page 302**.

Vehicles with a "Keyless Access" system **>>> page 68**: If the ignition cannot be switched on after connecting the 12-volt battery, lock and unlock the vehicle from the outside. Then try to switch on the ignition again. If the ignition does not work, seek professional assistance.

WARNING

Attaching the 12-volt battery incorrectly or using unsuitable batteries may result in short circuits, fire and serious injury.

- Use only maintenance-free 12 volt batteries with an anti-spill system with the same properties, specifications and dimensions as the factory-fitted battery.

WARNING

Charging the 12-volt battery creates a highly explosive mixture of detonating gases.

- Only charge the 12-volt battery in a well-ventilated place.
- Never charge a 12-volt battery that is frozen or has thawed. When the battery is discharged, it may freeze at temperatures close to 0°C (+32°F).
- If the 12-volt battery has frozen, have it replaced without fail.

- A short circuit may occur if the wires are incorrectly connected to the poles. First connect the positive cable and then the negative one.

NOTICE

- Never connect or disconnect the 12-volt battery when the ignition is switched on or the engine is running. Also, never use a 12-volt battery that does not meet the vehicle's battery specifications. The electrical system or certain electronic components could be damaged and electrical malfunctions could occur.
- Never connect accessories that supply power, such as solar panels or battery chargers, to the 12-volt socket or cigarette lighter, to charge the 12-volt battery. This could damage the vehicle's electrical system.

For the sake of the environment

- The battery may contain toxic substances, such as sulphuric acid and lead. Dispose of the 12-volt battery in accordance with the applicable regulations.
- Electrolyte can contaminate the environment. If any operating fluid leaks out, collect it and dispose of it properly.

Troubleshooting

Alternator fault

The control lamp lights up in **RED**. The following messages may be displayed:

The 12 V battery is not charging. Park safely!

Stop driving! Stop the vehicle at the next opportunity and in a safe place. The vehicle's battery is no longer charged from the alternator while driving, or there is a fault in the 12-volt on-board network. As the battery gradually discharges, switch off all electrical devices that are not essential.

- Switch off the ignition and any electrical consumers that are not required.
- Contact a specialised workshop.
- Request a check of the electrical system.

12-volt battery

The indicator lamp lights up **YELLOW**. The following message is displayed:

Low level of the 12 V vehicle battery. Charge while driving

Starting capacity may be limited. If this driver message goes out after a certain amount of time, the vehicle's battery has recharged while driving and reached a sufficient level. If the driver message does not go out, take the vehicle to a specialized workshop.

12-volt battery

The indicator lamp lights up **YELLOW**. The following message is displayed:

Error: 12-V vehicle battery. Engine cannot be started. Go to the workshop.

There is a fault in the connection between the on-board network and the 12-volt battery.

If the engine is switched off in this situation, it cannot be restarted. If necessary, use the jump leads » page 253 or seek assistance from qualified personnel.

- Contact a specialised workshop.
- Request a check of the electrical system.

Energy management

Optimisation of the starting capacity

Energy management controls the electrical power distribution so that there is always enough electrical power to start the engine.

If a vehicle with a conventional energy system remains stationary for a long period of time, the electrical devices, for example in the electronic ignition lock, discharge the battery. Under certain circumstances, this can lead to a lack of electrical power to start the engine.

In your vehicle, a smart energy management system is responsible for distributing the electrical energy. This clearly improves the starting performance and service life of the battery.

The main functions incorporated in the power management system are **battery diagnosis**, **residual current management** and a **dynamic power management system**.

Battery diagnostics

Battery diagnostics determine the status of the battery on an ongoing basis. The battery voltage, current and temperature are monitored for this purpose. This is used to determine the battery's charge level and efficiency.

Residual current management system

The residual current management reduces energy consumption while the vehicle is stationary. When the ignition is switched off, it manages the power supply to the various electrical devices. In doing so, it takes into account the battery diagnostic data.


Depending on the battery's charge level, it disconnects electrical devices one after the other to avoid over-discharging the battery and to maintain starting capacity.

Dynamic energy management system

Energy generated while driving is distributed by the dynamic energy management system to the electrical devices according to their energy requirements. It also ensures that no more energy is consumed than is generated, thus ensuring an optimal battery charge level.



Note

- The energy management system cannot override the limits imposed by the laws of physics. Please note that the capacity and service life of the battery are limited.
- When there is a risk that the vehicle will not start, the alternator power failure or low battery charge level warning lamp will be shown  » page 282.

Discharged battery

Maintaining starting capacity has top priority. Battery strain is considerable on short journeys, city driving and in the cold season of the year.

In these situations, a lot of energy is required but very little is generated. If the engine is stopped and at the same time the electrical devices are switched on, the battery can become discharged to a critical point. In this case energy is consumed without being generated at the same time.

In these situations you will notice that the energy regulation system performs active energy distribution adjustments.

Vehicle stationary for a long period of time

If you do not drive the vehicle for a few days or weeks, adjustments will be made to reduce consumption or the electrical devices will be deactivated one by one. This reduces energy consumption and the starting capacity is main-

tained for longer. Some convenience functions may not be available under certain circumstances. The convenience functions will be available again when the ignition is switched on and the engine is started.

With the engine stopped

If you listen to the radio, for example, while the engine is stopped, the battery will be discharged.

If the energy consumption means there is a risk that the engine will not start, a text will be displayed in vehicles with a driver information system.

This driver message indicates that the engine must be started to recharge the battery.

With the engine running

The battery may discharge despite the fact that energy is being generated while the vehicle is in motion. This is particularly the case if too little energy is generated and too much is consumed at a time while the battery's level of charge is not optimal.

To restore the energy balance, the devices that consume the most energy are either temporarily adjusted or deactivated. Heating systems, in particular, consume a lot of energy. If you notice, for instance, that the seat heating or the rear window heater is not working, they may have been temporarily switched off or regula-

ted to a lower heat output. These systems can be used again as soon as the energy balance has been restored.

If necessary, you may also notice a slight idling speed boost. However, this is normal and should not cause you any concern. Boosting the idling speed generates additional energy and charges the battery.

Wheels and tyres

Important information about wheels and tyres

General notes

- When driving with **new tyres**, be especially careful during the first 600 km (300 miles).
- If you have to drive over a kerb or similar obstacle, drive very slowly and as near as possible at a right angle to the obstacle.
- Check from time to time if the tyres are damaged (punctures, cuts, cracks or dents). Remove any foreign objects embedded in the treads.
- Damaged wheels and tyres must be replaced immediately.
- Keep grease, oil and fuel off the tyres.
- Replace any missing valve caps as soon as possible.
- Mark the wheels before taking them off so that they rotate in the same direction when put back.
- When removed, the wheels or tyres should be stored in a cool, dry and preferably dark place.

Low profile tyres

Low profile tyres have a wider tread, a larger wheel diameter and a lower sidewall height. This results in more agile driving behaviour.

Low profile tyres may deteriorate more quickly than standard tyres, for instance due to heavy impacts, potholes, manhole covers and kerbs. Correct tyre pressure is very important »» page 287.

To avoid damage to tyres and wheels, drive with special care when driving on roads in poor condition.

Visually check your wheels every 3000 km.

If the tyres or rims have received a heavy impact or have been damaged, have a specialised workshop check whether or not it is necessary to change the tyre.

Low profile tyres may deteriorate more quickly than standard tyres.

Concealed damage

Damage to tyres and rims is often not readily visible. If you notice unusual **vibration** or the car **pulling to one side**, this may indicate that one of the tyres is damaged. Reduce speed immediately if there is any reason to suspect that damage may have occurred. Inspect the tyres for damage. If no external damage is visible, drive slowly and carefully to the nearest specialised workshop and have the car inspected.

Foreign objects inserted in the tyre

- Do not remove foreign bodies if they have penetrated through the tyre wall!
- If the vehicle comes with a tyre mobility system, where necessary seal the damaged tyre as shown in section »» page 300.

Use a specialised workshop for repair or replacement. SEAT recommends visiting a SEAT dealership for this.

The sealant inside the tyre tread wraps around the foreign body and provisionally seals the tyre.

Tyres with directional tread pattern

An arrow on the tyre sidewall indicates the rotation direction on directional tyres. Always note the rotation direction indicated when mounting the wheel. This makes sure that optimal use is made of tyre properties in terms of aquaplaning, grip, excessive noise and wear.

Retrofitting of accessories

If you wish to change or fit wheels, rims or wheel trims, we recommend that you consult with a SEAT Official Service for advice regarding current techniques.

Speed symbols

The speed rating indicates the maximum speed permitted for the tyres.

P max. 150 km/h (93 mph)


- Q max. 160 km/h (99 mph)
- R max. 170 km/h (106 mph)
- S max. 180 km/h (112 mph)
- T max. 190 km/h (118 mph)
- U max. 200 km/h (124 mph)
- H max. 210 km/h (130 mph)
- V max. 240 km/h (149 mph)
- Z max. 240 km/h (149 mph)
- W max. 270 km/h (168 mph)
- Y max. 300 km/h (186 mph)

WARNING

- **New tyres do not have maximum grip during the first 600 km. Drive particularly carefully to avoid possible accidents.**
- **Never drive with damaged tyres. This may cause an accident.**
- **If you notice unusual vibrations or if the vehicle pulls to one side when driving, stop the vehicle immediately and check the tyres.**
- **Never use old tyres or those with an unknown history of use.**

New wheels and tyres

It is best to have all wheels and tyres serviced by a specialised workshop. There they have the required knowledge, the special tools and the corresponding spare parts.

- Even winter tyres lose their grip on ice. If you have installed new tyres, drive the first 600 km carefully and at a moderate speed.
- All four wheels must be fitted with tyres of the same type, size (rolling circumference) and, if possible, tread pattern.
- When changing tyres, do not change just one; change at least two on the same axle.
- If you want to equip your vehicle with a combination of tyres and rims that are different to those fitted in the factory, inform your specialised workshop before purchasing them »» 

The sizes of the rims and tyres approved for your vehicle are listed in the vehicle documentation (e.g. EC Certificate of Conformity or COC document¹⁾). The vehicle documentation varies depending on the country of residence.

If the type of spare wheel is different from the normal wheels — e.g. in the case of winter tyres or particularly wide tyres — the spare wheel should only be used temporarily in the event of a puncture, and the vehicle should be driven with care. Refit the normal road wheel as soon as possible.

In vehicles with four-wheel drive, the 4 wheels must be fitted with tyres of the same brand, type and tread so that the traction system is not damaged by a difference in the number of turns of the wheels. Therefore, in the event of a puncture, only a spare wheel with the same perimeter as normal tyres should be used.

Manufacturing date

The manufacturing date is also indicated on the tyre sidewall (or on the inside face of the wheel):

DOT ... 2220 ...

this means, for example, that the tyre was manufactured in the 22nd week of 2020.

WARNING

- **Use only combinations of tyres and rims, as well as suitable wheel nuts, approved by SEAT. Otherwise the vehicle may be damaged, causing an accident.**
- **For technical reasons it is not possible to use wheels of other vehicles; in some cases not even wheels from the same vehicle model should be used.**
- **Always ensure that the tyres you have chosen have adequate clearance. When selecting replacement tyres, do not rely entirely on the nominal tyre size marked on the tyre, since the nominal tyre size can differ**

¹⁾ COC = certificate of conformity.

significantly depending on the manufacturer. Lack of clearance can damage the tyres or the vehicle and, as a result, endanger road safety. Accident hazard!

- Only use tyres that are over 6 years old in an emergency, and drive with due care.
- The fitting of tyres with run-flat properties is not permitted on your vehicle! Prohibited use can cause accidents or can damage your vehicle.
- If decorative hubcaps are retrofitted, make sure that they allow enough air in to cool the braking system. Accident hazard!
- Models with aerodynamic wheel rims and/or with bolt-on plastic elements (more enclosed design) increase the likelihood of ice and snow accumulating on the inside. This should be taken into account, depending on the driving situations, as snow or ice accumulated in the wheels can cause vibration in the vehicle when it drives at over 40 km/h. It is advisable to remove ice and snow from the inside of the wheels using hot water.
- If you drive on dirt or gravel tracks, the likelihood of stones becoming trapped inside wheel rims with plastic elements increases when driving at high speed or in a sporty manner. If you see that there are stones trapped between the aluminium wheel rim and the insert, you can attempt to remove them using pressurised water.

For the sake of the environment

Old tyres must be disposed of according to each country's laws.

Note

- A SEAT Service Centre should be consulted to find out whether wheels or tyres of different sizes to those originally fitted by SEAT can be fitted, and to find out about the combinations allowed between the front axle (axle 1) and the rear axle (axle 2).
- Never mount used tyres if you are not sure of their "previous history".

Tyre life

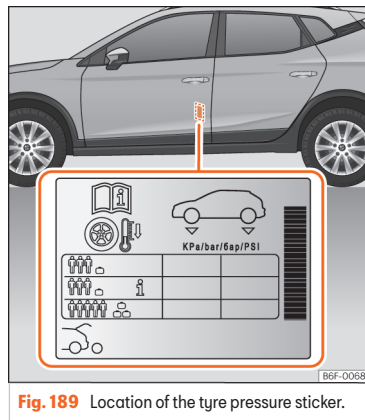


Fig. 189 Location of the tyre pressure sticker.

Correct inflation pressures and sensible driving habits will increase the useful life of your tyres.

- Check tyre pressure at least once a month, and also prior to any long trip.
- The tyre pressure should only be checked when the tyres are cold. Do not reduce the pressure of warm tyres.
- Adjust tyre pressure to the load being carried by the vehicle »» **Fig. 189**.
- In vehicles with a tyre pressure indicator, save the modified tyre pressure »» **page 297**.

- Avoid fast cornering and hard acceleration.
- Inspect the tyres for irregular wear from time to time.

Tyre pressure

The tyre pressure values are shown on the sticker located on the rear frame of the front left door >>> **Fig. 189**.

Insufficient or excessive pressure greatly reduces the useful life of the tyres and adversely affects vehicle performance and ride. Correct inflation pressures are very important, especially at **high speeds**.

The tyre pressure must be adjusted according to the load the vehicle is carrying. If the vehicle is going to be fully loaded, increase the tyre pressure to the maximum load value shown on the sticker >>> **Fig. 189**.

Do not forget the spare wheel when checking the tyre pressures: Keep this spare wheel inflated to the highest pressure required for the road wheels.

In the case of a minimised temporary spare wheel (125/70 R16 or 125/70 R18) inflate to a pressure of 4,2 bar as indicated on the tyre pressure label >>> **Fig. 189**.

Depending on the vehicle, tyre pressure can be adjusted to medium load to improve driving comfort [tyre pressure **i** >>> **Fig. 189**]. When driving with comfort tyre pressure, fuel consumption may increase slightly.

Driving style

Fast cornering, heavy acceleration and hard braking (squealing tyres) all increase tyre wear.

Wheel balance

The wheels on new vehicles are balanced. However, certain circumstances may lead to imbalance (run-out), which is detected as vibrations in the steering wheel.

Unbalanced wheels should be rebalanced, as they otherwise cause excessive wear on steering, suspension and tyres. A wheel must also be rebalanced when a new tyre is fitted or if a tyre is repaired.

Incorrect wheel alignment

Incorrect running gear alignment causes excessive tyre wear, impairing the safety of the vehicle. If you notice excessive tyre wear, you should check wheel alignment at a SEAT Official Service.

WARNING

Unsuitable handling of the wheels and tyres may lead to sudden tyre pressure losses, tread separation or even a blow-out.

- **The driver is responsible for ensuring that all of the vehicle tyres are correctly inflated to the right pressure. The recommended tyre pressure is indicated on the label >>> Fig. 189.**

- **Check tyre pressures regularly and ensure they are kept at the indicated pressures. Tyre pressure that is too low could cause overheating, resulting in tread detachment or even burst tyres.**

- **Tyre pressure should be as indicated on the label when the tyres are cold at all times >>> Fig. 189.**

- **Regularly check the cold inflation pressure of the tyres. If necessary, change the tyre pressure of the vehicle tyres while they are cold.**

- **Regularly check your tyres for damage and wear.**

- **Never exceed the speed limit or loads specified for the type of tyre fitted on your vehicle.**

For the sake of the environment

Under-inflated tyres will increase fuel consumption.

Tread wear indicators

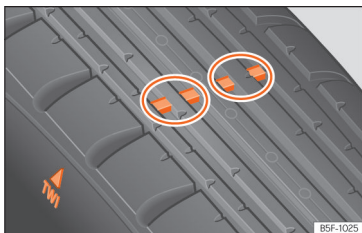


Fig. 190 Tyre profile: tread wear indicators.

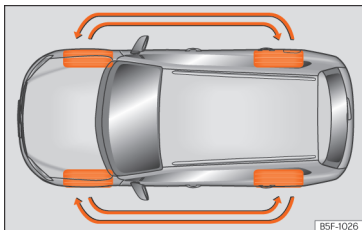


Fig. 191 Interchanging tyres.

Wear indicators around 1.6 mm high can be found on the base of the original tyre treads, ordered at regular intervals and running across the tread >>> **Fig. 190**. The letters "TWI" or triangles on the sidewall of the tyre mark the position of the wear indicators.

¹⁾ Follow the regulations of the country you are driving in.

The minimum permitted profile depth ¹⁾ have been reached when the tyres have worn down to the wear indicators. Replace the tyres with new ones >>> ⚠.

With a sporty driving style, check the tread depth every 5,000 / 10,000 km (3,000 / 6,000 mi). When checking the tread depth, check the wear indicators in all the tyre grooves.

Changing wheels around

In order to wear the wheels in a uniform manner, it is recommended to interchange them regularly according to the diagram >>> **Fig. 191**. The useful life of all the tyres will then be about the same time.

⚠ WARNING

The tyres must be replaced at the latest when the tread is worn down to the tread wear indicators. Failure to follow this instruction could result in an accident.

- Particularly in difficult driving conditions such as wet or icy roads. It is important that the tyre tread be as deep as possible and be approximately the same on the tyres of both the front and the rear axles.
- The scant driving safety due to insufficient tread depth is particularly evident in vehicle handling, when there is a risk of "aquaplan-

ing" in deep puddles of water and when driving through corners, and braking is also adversely affected.

- The speed has to be adapted accordingly, otherwise there is a risk of losing control over the vehicle.

Wheel nuts

The **wheel nuts** and rims have been designed to be part of an assembly. When installing different wheels (for instance alloy wheels or wheels with winter tyres) it is important to use the correct wheel nuts with the right length and correctly shaped bolt heads. This ensures that wheels are fitted securely and that the brake system functions correctly.

The wheel nuts must be clean and turn easily. A special adapter is required to turn the anti-theft wheel nuts >>> page 294.

⚠ WARNING

Wheel nuts should never be greased or oiled.

- Use only wheel nuts which belong to the wheel.
- If the required torque of the wheel nuts is too low, they could loosen whilst the vehicle is in motion. Risk of accident! If the tightening torque is too high, the wheel nuts and threads can be damaged.

NOTICE

See »» page 296 to find out the recommended tightening torque for wheel nuts for steel and alloy rims.

Winter tyres

- Winter tyres must be fitted on **all four** wheels.
- Only use winter tyres that are approved for your vehicle.
- Please note that the maximum permissible speed for winter tyres may be lower than for summer tyres.
- Also note that winter tyres are no longer effective when the **tread** is worn down.
- After fitting the wheels you must always check the tyre pressures. When doing so, take into account the correct tyre pressures listed on the rear of the front left door frame »» page 287.

In winter road conditions winter tyres will considerably improve vehicle handling. The design of summer tyres (width, rubber compound, tread pattern) gives less grip on ice and snow. This applies particularly to vehicles equipped with **wide section tyres** or with **high speed tyres** (code letters H, V or Y on the sidewall).

Only use winter tyres of the correct type approved for your vehicle. The sizes of these tyres are specified in the vehicle's documents (e.g.

EC Certificate of Conformity or COC¹⁾). The vehicle documentation varies depending on the country of residence.

Winter tyres lose a great deal of their properties when the **tread** is worn down to a depth of 4 mm.

The performance of winter tyres is also severely impaired by **ageing**, even if the tread is still much deeper than 4 mm.

A code letter indicating the speed limit is stamped on all winter tyres »» page 285.

In the infotainment system's **Vehicle settings** menu, a speed warning can be set in the **Tyres** menu.

Vehicles capable of exceeding these speeds must have an appropriate **sticker** attached so that it is visible to the driver. Suitable stickers are available from the SEAT Official Service and specialised workshop. Please note the regulations to this effect in your country.

"All-weather" tyres can also be used instead of winter tyres.

Using winter tyres with a V-rating

Please note that the generally applicable 240 km/h (149 mph) speed for winter tyres with the letter V is subject to **technical restrictions; the maximum permissible speed for your vehicle may be significantly lower**. The maximum speed limit for these tyres depends

directly on the maximum axle weights for your car and on the listed weight rating of the tyres being used.

It is best to contact a SEAT Official Service to check the maximum speed which is permissible for the V-rated tyres fitted on your car on the basis of this information.

WARNING

Exceeding the maximum speed permitted for the winter tyres fitted on your car can cause tyre failure, resulting in a loss of control of the vehicle – risk of accident.

For the sake of the environment

When winter is over, change back to summer tyres at an appropriate moment. In temperatures above +7°C (+45°F), performance will be improved if summer tyres are used. Rolling noise, wear and energy consumption will all be reduced.

Snow chains

Snow chains **are only permitted on the front wheels**, even on **4-wheel drive** vehicles.

- Check that they are correctly seated after driving for a few yards; correct the position if necessary, in accordance with the manufacturer's fitting instructions.

¹⁾ COC = certificate of conformity.

Changing a wheel

- Keep your speed below 50 km/h (30 mph).
- If there is a danger of being trapped despite having fitted the chains, it is best to disable the traction control (TCS) in the ESC »» page 133.

Snow chains will improve *braking ability* as well as *traction* in winter conditions.

For technical reasons, the use of snow chains is only permitted on the following rim and tyre combinations:

Tyres	Wheel rim	Chains
195/60 R16	6Jx16 ET45	Max. link 13.5 mm
205/60 R16	6Jx16 ET45	Max. link 9 mm
205/55 R17	6.5Jx17 ET48	
215/45 R18	7Jx18 ET47	

Other dimensions do not allow chains

Remove any central wheel trims before fitting snow chains.

WARNING

The use of unsuitable or incorrectly fitted chains could lead to serious accidents and damage.

- Always use appropriate snow chains.
- Observe the fitting instructions provided by the snow chain manufacturer.

- Never exceed the speed limits when driving with snow chains.
- Before fitting the chains, check that the wheel/tyre combination on the table is the one installed on your vehicle. The combination can also be found on the technical data-sheet.

NOTICE

- Remove the snow chains to drive on roads without snow. Otherwise they will impair vehicle handling, damage the tyres and wear out very quickly.
- Wheel rims may be damaged or scratched if the chains come into direct contact with them. SEAT recommends the use of covered snow chains.

Changing a wheel

Introduction

Only change a wheel yourself if you are familiar with the necessary operations and safety measures, if you have the necessary tools and if the vehicle is parked safely.

Preliminary actions

- Stop the vehicle on a level surface and in a safe place, as far away from road traffic as possible.
- Apply the parking brake.
- Switch on the hazard warning lights.
- *Manual transmission*: engage 1st gear.
- *Automatic transmission*: switch on the parking lock **P**.
- If towing a trailer, unhitch the trailer from your vehicle.
- Lay out the on-board tools »» page 251 and the wheel to be changed.
- Follow the legal provisions of each country (reflective vest, warning triangles, light beacon, etc.).
- Get all occupants out of the vehicle and keep them out of the danger zone (e.g. behind the guard rail).

WARNING

- Always observe the above steps and protect yourself and other road users.
- If you change the wheel on a slope, block the wheel on the opposite side of the car with a stone or similar to prevent the vehicle from moving.

Location and use of the temporary spare wheel

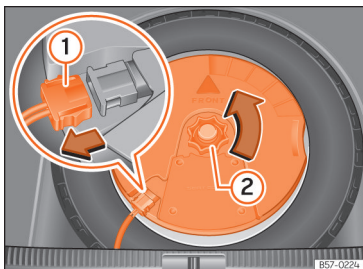


Fig. 192 In the boot: remove the subwoofer.

The temporary spare wheel is stored under the floor panel in the luggage compartment and is attached by a thumbnut.

The temporary spare wheel has been designed to be used for short periods of time. Have the tyres checked and replaced as soon as possible at a SEAT Official Service or at a specialised workshop.

The spare wheel must not be switched for a spare wheel from another vehicle.

Removing the temporary spare wheel

- Lift and hold up the floor panel to remove the temporary spare wheel >>> **page 229**.
- Turn the thumb wheel anticlockwise.
- Take out the temporary spare wheel.

Getting the spare wheel out of vehicles fitted with the optional sound system (with subwoofer)

To remove the spare wheel, you must first remove the subwoofer.

- *Vehicles without a variable floor in the luggage compartment:* pull the floor of the luggage compartment (carpet) upwards to get it out.
- *Vehicles with a variable luggage compartment floor:* lift and secure the floor storage compartment as explained in >>> **page 229**.
- Disconnect the subwoofer's speaker cable >>> **Fig. 192 ①**.
- Turn the securing wheel anti-clockwise >>> **Fig. 192 ②**.
- Remove the subwoofer speaker and the spare wheel.
- When re-mounting the spare tyre, place the subwoofer on the base of the wheel rim with care. When doing so, the tip of the "FRONT" arrow on the subwoofer should point forward.

- Reconnect the speaker cable and firmly rotate the securing wheel clockwise so that the subwoofer system and wheel are firmly in place.

Removing the 16" temporary spare wheel (without subwoofer)

- Remove the luggage compartment variable floor to access the wheel and the tools >>> **page 229**.
- Loosen the strap that secures the box by pressing on the buckle.
- Remove the toolbox.
- Turn the securing wheel anti-clockwise and remove it.
- Press the thread and turn it 90° clockwise or anti-clockwise and remove it.
- Pull on the front part of the spare wheel to remove it.

Chains

For technical reasons, snow chains must not be used on the temporary spare wheel.

If you have a puncture on one of the front wheels when using snow chains, fit the temporary spare wheel in place of one of the rear wheels. Fit the snow chains on the rear wheel that you have removed and replace the punctured front wheel with this wheel.

⚠ WARNING

- After fitting the temporary spare wheel, check the tyre pressures as soon as possible. Failure to do so may cause an accident. The tyre pressure is listed on the back of the left front door frame >>> page 287.
- Do not drive at over 80 km/h [50 mph] when the temporary spare wheel is fitted on the vehicle: Accident risk!
- Never travel more than 200 km using a temporary spare wheel.
- Avoid heavy acceleration, hard braking and fast cornering: Accident risk!
- Never use more than one temporary spare wheel at the same time, risk of accident.
- No other type of tyre (normal summer or winter tyre) may be fitted on the compact temporary spare wheel rim.
- If you are driving using the spare wheel, the ACC system could automatically switch off during the journey. Switch off the system when starting off.

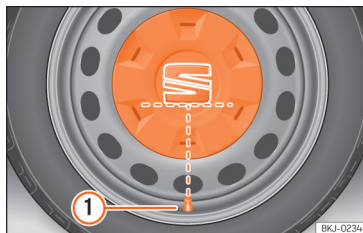
Wheel central trim

Fig. 193 Correct positioning of the central wheel trim for steel rims.

The central trims must be removed for access to the wheel nuts.

Removing

- Attach the wire hook (vehicle tools >>> page 251) to one of the recesses of the central wheel trim and remove it.

Fitting

- Fit the central wheel trim onto the rim. The bottom of the "S" of the SEAT badge should align with the inflation valve >>> Fig. 193 ①.
- Press the central trim firmly until it locks in with an audible click.

i Note

There is also a valve mark on the back of the central wheel trim that indicates the correct alignment.

Wheel nut caps

Fig. 194 Wheel: wheel nuts with caps.

Removal

- Fit the plastic clip (vehicle tools >>> Fig. 157) over the cap until it clicks into place >>> Fig. 194.
 - Remove the cap with the plastic clip.
- The caps protect the wheel nuts and should be remounted after changing the tyre.
- The **anti-theft wheel locking bolt** has a special cap. This only fits on anti-theft locking bolts and is not for use with standard wheel nuts.

Anti-theft wheel nuts

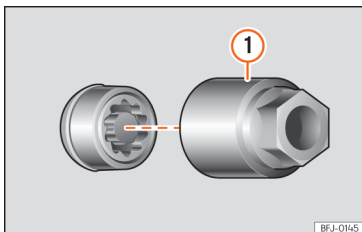


Fig. 195 Anti-theft wheel nut with cap and adapter.

Loosening the anti-theft wheel nut

- Remove the wheel trim or hub cap.
- Insert the special adapter **»» Fig. 195 ①** (vehicle tools **»» page 251**) onto the anti-theft wheel nut and push it on as far as it will go.
- Insert the wheel wrench (vehicle tools) onto the adapter as far as it will go.
- Remove the wheel nut **»» page 294**.

Note

Make a note of the code number of the anti-theft wheel nut and keep it in a safe place, but not in your vehicle. If you need a new adapter, you can obtain it from the SEAT Official Service, by giving the code number.

Loosening wheel nuts

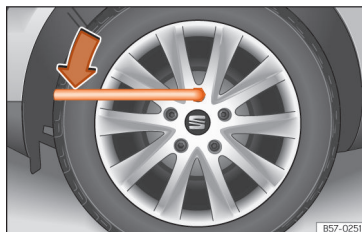


Fig. 196 Tyre change: loosen the wheel nuts.

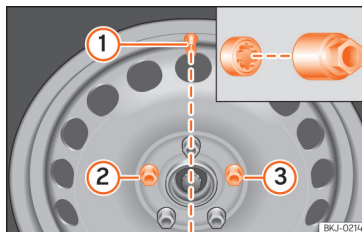


Fig. 197 Tyre change: tyre valve ① and the correct position for the anti-theft wheel locking bolt ② or ③.

Use only the wheel wrench belonging to the car to loosen the wheel nuts.

Loosen the wheel nuts only about one turn before raising the vehicle with the jack.

If the wheel nut is very tight, carefully push on the end of the wheel wrench with your foot. Hold on to the vehicle for support and take care not to slip during this operation.

Loosening wheel nuts

- Fit the box spanner into the bolt as far as it will go **»» Fig. 196**.
- Hold the wrench at the end and rotate the bolt approximately *one* turn anticlockwise **»» ⚠**.

Important information about wheel nuts

Factory-fitted rims and wheel nuts are specially matched during construction. Therefore, if different rims are fitted, the correct wheel nuts with the right length and heads must be used. This ensures that wheels are fitted securely and that the brake system functions correctly.

In certain circumstances, you should not even use wheel nuts from vehicles of the same model.

On wheels with integral hubcaps, the anti-theft wheel locking bolt must be screwed in the positions **»» Fig. 197 ②** or **③**, taking as reference the position of the tyre valve **①**. Otherwise it will not be possible to mount the hubcap.

⚠ WARNING

If the wheel nuts are not properly tightened, they could come loose while driving and cause an accident, serious injury and loss of vehicle control.

- Use only wheel nuts which correspond to the rim in question.
- Never use different wheel nuts.
- Wheel nuts and threads should be clean, free of oil and grease, and it should be possible to screw them easily.
- To loosen and tighten wheel nuts, only use the wheel wrench that came with the car from the factory.
- The wheel nuts should only be loosened slightly (about one turn) before raising the vehicle with the jack. Risk of accident!
- Never apply grease or oil to wheel nuts or to the wheel hub threads. Even if the bolts have been tightened to the required torque, they could come loose while driving.
- Never loosen the screwed joints of wheel rims with bolted ring trims.
- If wheel nuts are tightened below the required torque, the bolts and rims could come loose while driving. If tightening torque is too high, the wheel nuts or threads can be damaged.

Raise the vehicle

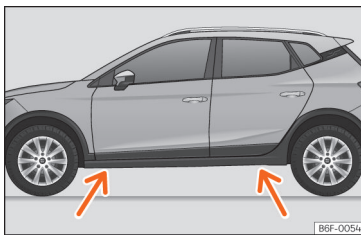


Fig. 198 Jack position points.

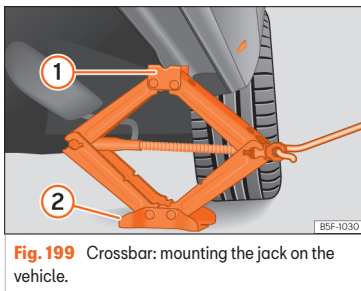


Fig. 199 Crossbar: mounting the jack on the vehicle.

- Rest the jack (vehicles tools) on firm ground. If necessary use a large, strong board or similar support. If the surface is slippery (for example tiles) place the jack on a rubber mat or similar to prevent it from slipping >>> ⚠.

- Look on the crossbar for the mark of the jack support point (sunken area) closest to the wheel to be changed >>> **Fig. 198**.

- Turn the jack crank handle, located below the crossbar support point, to raise it until the tab ① >>> **Fig. 199** is below the housing that is provided.
- Align the jack so that the tab ① “grips” onto the housing provided on the cross member and the mobile base ② is resting on the ground. The base plate ② should fall vertically with respect to the support point ①.
- Continue turning the jack until the wheel is slightly lifted off the ground.

⚠ WARNING

The factory-supplied jack is only designed for changing wheels on this model. On no account attempt to use it for lifting heavier vehicles or other loads. Risk of injury.

- Make sure the jack remains stable. If the surface is slippery or soft, the jack could slip or sink, respectively, with the consequent risk of causing injuries.
- Lift the vehicle using only the jack supplied from the factory. Other jacks, even those approved for other SEAT models could slip, with the consequent risk of injury.

- Place the jack only at the support points provided on the crossbar and align it. Otherwise, the jack could slip because it does not have sufficient grip on the vehicle. Risk of injury!
- You should never place a body limb such as an arm or leg under a raised vehicle that is solely supported by the jack.
- If you have to work underneath the vehicle, you must use suitable stands additionally to support the vehicle. Accident risk!
- Never raise the vehicle if it is tilting to one side or the engine is running.
- Never start the engine when the vehicle is raised. The vehicle may come loose from the jack due to the engine vibrations.

NOTICE

- The vehicle must not be raised on the crossbar. Place the jack only at the support points provided on the crossbar and align it. Otherwise, the vehicle may be damaged.
- Any type of load or weight applied to the external trim/door (treading on it, fitting the jack, resting heavy objects, etc.) can cause damage to it. SEAT accepts no responsibility for any damages caused by improper use of the external trim or body.

Removing and installing a wheel

Change the wheel after loosening the wheel bolts and raising the vehicle with the jack.

When removing/fitting the wheel, the rim may hit and damage the brake disc. Therefore, please take care and get a second person to assist you.

Taking off the wheel

- Unscrew the bolts with the wheel wrench and place them on a clean surface.
- Remove the wheel.

Putting on the spare wheel

Check the direction of rotation of the tyre
»» page 296.

- Place the spare wheel or temporary spare wheel into position.
- Screw in the wheel bolts and tighten them a little with the wheel wrench.
- Use the appropriate adapter to tighten the anti-theft wheel bolts.
- Carefully lower the vehicle using the jack.
- Use the wheel spanner to tighten all of the wheel nuts clockwise. Tighten the bolts in diagonal pairs (not in a circle).
- Put the caps, trim or full hubcap back on.

Tightening torque of the wheel nuts

The prescribed tightening torque for wheel bolts for steel and alloy wheels is **120 Nm**.

After changing a wheel, have the tightening torque checked immediately with a torque wrench that is working perfectly.

The wheel bolts should be clean and turn easily. Before fitting the spare wheel, inspect the wheel condition and hub mounting surfaces. These surfaces must be clean before fitting the wheel.

Before checking tightening torque, have any rusty wheel bolts that are difficult to screw replaced and clean the wheel hub threads.

Never apply grease or oil to wheel bolts or to the wheel hub threads. Even if the bolts have been tightened to the prescribed torque, they could come loose while driving.

Tyres with directional tread pattern

Tyres with directional tread pattern have been designed to operate best when rotating in only one direction. An arrow on the tyre sidewall indicates the rotation direction on tyres with directional tread. Always observe the indicated rotation direction in order to guarantee optimum grip and help avoid aquaplaning, excessive noise and wear.

If the tyre is mounted in the opposite rotation direction, drive with extreme caution, as the tyre is no longer being used correctly. This is of

particular importance when the road surface is wet. Change the tyre as soon as possible or remount it with the correct rotation direction.

Works after changing a wheel

- Replace the hub caps or wheel nut caps (depending on equipment).
- Return all tools to their proper storage location.
- If the replaced wheel does not fit in the spare wheel housing, store it safely in the luggage compartment »» page 227.
- Check the tyre pressure of the newly mounted tyre as soon as possible.
- In vehicles fitted with a tyre pressure indicator, adjust the pressure and store it in the memory »» page 297.
- Have the tightening torque of the wheel nuts checked as soon as possible with a torque wrench »» page 296. Meanwhile, drive carefully.
- Have the flat tyre replaced as quickly as possible.

Tyre pressure monitor system

Tyre pressure monitor indicator



Fig. 200 Instrument cluster: warning of loss of tyre pressure.

The tyre pressure monitoring system compares the individual speeds of each wheel and thus the dynamic radius with the help of the ABS sensors.

The tyre pressure monitor indicator warns of any change in the tread diameter of a wheel »» **Fig. 200**.

Change in wheel diameter

The wheel diameter changes when:

- Tyre pressure is changed manually.
- The tyre pressure is insufficient.
- The tyre's structure is damaged.

- The vehicle is not level due to a load.
- The wheels on an axle are subject to a heavier load (e.g. with a heavy load).
- The vehicle is fitted with snow chains.
- The temporary spare wheel is fitted.
- One wheel has been changed on an axle.

There may be a delay in the reaction of the tyre pressure monitoring indicator (ⓘ) or it may not indicate anything under certain circumstances (e.g. sporty driving, snow-covered or unpaved roads, or when driving with snow chains).

Calibrate the tyre pressure monitoring indicator

After changing the tyre pressure or replacing one or more wheels, the tyre pressure monitoring indicator must be recalibrated. This should also be done, for example, when switching the front and rear tyres.

It should be calibrated with the vehicle stopped and its tyres cold. If calibrated while the tyres are hot, the pressure check and calibration procedure should be repeated when cold before the next trip.

- Switch the ignition on.
- Save the new inflation pressure in the Infotainment system: function button ⓘ > **Vehicle > Settings > Tyres > SET**.
- **OR:** function button ⓘ > **Vehicle > Selection > Vehicle status > Tyre pressure control > SET** »» page 36.


After storing the new inflation pressure, a confirmation message will be displayed, the warning light in the instrument cluster will flash briefly and a driver alert tone will be played.

The tyre pressure loss indicator uses the ABS sensors to compare the turns of each wheel and, therefore, their tread circumferences, among other aspects. The set values are collected and monitored after a long journey at different speeds.

For example, if the wheels are under very heavy loads, the tyre pressure must be increased to the total recommended tyre pressure before calibration >>> **Fig. 200.**

WARNING

If the tyres are inflated to different pressures, or to a pressure that is too low, a tyre may be damaged and control of the vehicle may be lost. This could lead to a serious or even fatal accident.

- If the lamp  lights up, reduce speed immediately and avoid any sudden turning or braking manoeuvres. Stop as soon as possible, and check the pressure and status of all tyres.
- The tyre pressure loss indicator only works correctly if all the tyres are at the correct pressure when cold, and it is subsequently calibrated according to the described procedure.

- If the tyres have no punctures and do not need to be replaced immediately, drive to the nearest specialist workshop at low speed and have the tyre pressure checked and corrected.

Note


- When driving for the first time with new tyres at high speeds, the tyres may expand slightly, which may result in an air pressure warning.
- If a low tyre pressure is detected when the ignition is switched on, an audible warning will sound. If the system fails, an audible signal sounds.
- Driving on unpaved roads for a long period of time, or sporty driving, may temporarily deactivate the system. The warning lamp shows a fault, but disappears when road conditions or driving behaviour change.
- Do not only rely on the tyre pressure monitoring system. Check the tyres regularly to ensure that the tyre pressures are correct and that the tyres are free of damage such as punctures, cuts, gouges and dents. Remove any non-puncturing objects from the tyres.
- The tyre pressure monitoring indicator does not function when there is a fault in the ESC or ABS >>> page 132.

Troubleshooting

Low tyre pressure

The control lamp switches on yellow.

The inflation pressure of one or more wheels is much lower than the value set by the driver, or the tyre has structural damage.

-  **Stop the vehicle!** Stop the vehicle as soon as possible in a safe place.
- Check all tyres and pressures.
- Replace any damaged tyres.

OR: Fault in the tyre pressure gauge.

Consult a specialised workshop if the tyre pressure is correct and the lamp remains lit after switching the ignition off and back on again.

Tyre repair

TMS (Tyre Mobility System) puncture repair kit

The puncture repair kit (Tyre Mobility System) will reliably seal punctures caused by the penetration of a foreign body of up to about **4 mm** in diameter. **Do not remove foreign objects, e.g. screws or nails, from the tyre.**

After inserting the sealant residue in the tyre, you must again check the tyre pressure about 10 minutes after starting the engine.

You should only use the tyre mobility set if the vehicle is parked in a safe place, you are familiar with the procedure and you have the necessary tyre mobility set. Otherwise, you should seek professional assistance.

Tyre sealant must not be used in the following cases:

- If the wheel rim has been damaged.
- In outside temperatures below -20°C [-4°F].
- If the cut or punctures in the tyres are larger than 4 mm.
- If the tyre has been driven on with very low inflation pressure or no tyre pressure.
- If the expiry date of the sealant bottle has passed.

⚠ WARNING

Using the puncture repair kit can be dangerous, particularly when filling the tyre on the roadside. To reduce the risk of serious injury, consider the following:

- Stop the vehicle as soon as possible in a safe place. Park it at a safe distance from road traffic to fill the tyres.
- Make sure the ground is flat and firm.
- All occupants, especially children, should stay a safe distance away from the work area.
- Turn on the hazard lights to warn other road users.

- Always stop the engine, apply the parking brake and engage a gear (for manual transmission), or activate parking lock P (for automatic transmission) to reduce the risk of the vehicle moving unintentionally.
- Use the puncture repair kit only if you are familiar with the necessary operations. Otherwise, you should seek professional assistance.
- The puncture repair kit should only be used in an emergency, to reach the nearest garage.
- Replace tyres repaired with the puncture kit as soon as possible.
- The sealant is harmful to health and must be cleaned off immediately if it comes into contact with the skin.
- Always keep the puncture repair kit out of the reach of children.

⚠ WARNING

A tyre filled with sealant does not have the same driving properties as a conventional tyre.

- Never drive faster than 80 km/h [50 mph].
- Avoid full throttle, braking heavily and cornering at high speeds.
- Drive for only 10 minutes at a maximum speed of 80 km/h [50 mph] and then check the tyre.

🌿 For the sake of the environment

Dispose of used or expired tyre sealant in accordance with the relevant legal requirements.

i Note

You can purchase new bottles of tyre sealant from SEAT dealers.

i Note

Take into account the separate instruction manual provided by the tyre mobility system manufacturer.

Tyre mobility system contents

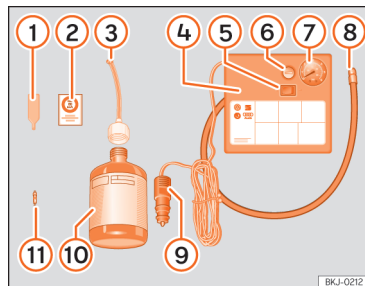


Fig. 201 Standard display: contents of the tyre mobility system.

The tyre mobility system is located underneath the floor covering in the luggage compartment. Includes the following components >>> **Fig. 201:**

- ① Valve insert remover
- ② A sticker to be stuck to the instrument cluster, in the driver's field of view, as a reminder of the advisable maximum speed "max. 80 km/h" or "max. 50 mph"
- ③ Filler tube with cap
- ④ Air compressor (depending on the version, the model may vary).
- ⑤ ON/OFF switch
- ⑥ Air bleed screw (it can also be integrated in the inflator tube).
- ⑦ Warning provided by tyre pressure monitoring system (it can also be integrated in the inflator tube).
- ⑧ Tube for inflating tyres
- ⑨ 12 volt connector
- ⑩ Bottle of sealant
- ⑪ Spare tyre valve

The **valve insert remover** ① has a gap at the lower end for a valve insert. The valve insert can only be screwed or unscrewed in this way. This also applies to its replacement part ⑪.

Sealing and inflating a tyre

Sealing the tyre

- Unscrew the tyre valve cap and insert. Use the device >>> **Fig. 201** ① to remove the valve cap. Place it on a clean surface.
- Shake the tyre sealant bottle vigorously >>> **Fig. 201** ⑩.
- Screw the tyre inflation hose >>> **Fig. 201** ③ into the tyre sealant bottle. The bottle's seal will break automatically.
- Remove the filler cap >>> **Fig. 201** ③ and screw the open end of the tube into the tyre valve.
- With the bottle upside down, empty **all** of the contents into the tyre.
- Remove the bottle from the valve.
- Replace the valve insert with the device >>> **Fig. 201** ① onto the tyre valve.

Inflating the tyre

- Screw the tyre inflation tube of the compressor >>> **Fig. 201** ⑧ onto the tyre valve.
- Check that the air evacuation screw is closed >>> **Fig. 201** ⑥.
- Start the engine and leave it running.
- Attach the connector >>> **Fig. 201** ⑨ to the vehicle's 12 volt power outlet >>> **page 180**.
- Switch on the air compressor with the ON/OFF switch >>> **Fig. 201** ⑤.

- Keep the air compressor running until it reaches a pressure of 2.0-2.5 bar [29-36 psi/ 200-250 kPa]. **A maximum of 8 minutes.**
- Disconnect the air compressor.
- If it does not reach the indicated pressure, unscrew the tyre inflator tube from the valve.
- Move the vehicle 10m so that the sealant is distributed throughout the tyre.
- Screw the compressor tyre inflator into the valve.
- Repeat the inflation process.
- If it still does not come up to pressure, the tyre is too badly damaged. Stop and seek assistance from authorised personnel.
- Disconnect the air compressor. Unscrew the tyre inflation tube from the tyre valve.
- When the tyre pressure is between 2.5 and 2.0 bars, continue driving without exceeding 80 km/h (50 mph).
- Attach the sticker >>> **Fig. 201** ② to the instrument cluster display, within the driver's field of vision.
- Check the pressure again after 10 minutes >>> **page 301**.

⚠ WARNING

When inflating the wheel, the air compressor and the inflator tube may become hot.

- Protect hands and skin from hot parts.
- Do not place the hot flexible inflator tube or hot air compressor on flammable material.
- Allow them to cool before storing the device.
- If it is not possible to inflate the tyre to at least 2.0 bars (29 psi / 200 kPa), the tyre is too badly damaged. The sealant is not in a good condition to seal the tyre. Do not continue driving. Seek specialist assistance.

ⓘ NOTICE

Switch off the air compressor after a maximum of 8 minutes of operation to avoid overheating! Before switching on the air compressor again, let it cool for several minutes.

Check after 10 minutes of driving

Screw in the inflator tube >>> Fig. 201 **8** again and check the pressure on the gauge **7**.

1.3 bar (19 psi / 130 kPa) or lower:

- **Stop the vehicle!** The tyre cannot be sealed sufficiently with the tyre mobility set.
 - You should obtain professional assistance
- >>> **⚠**.

1.4 bar (20 psi/140 kPa) and higher:

- Set the tyre pressure to the correct value again.
- Carefully resume your journey until you reach the nearest specialised workshop without exceeding 80 km/h (50 mph).
- Have the damaged tyre replaced.

⚠ WARNING

Driving with an unsealed tyre is dangerous and can cause accidents and serious injury.

- Do not continue driving if the tyre pressure is 1.3 bar (19 psi / 130 kPa) or lower.
- Seek specialist assistance.

Maintenance

Service

Service work and the Digital Maintenance Plan

Log of services performed (“Digital Maintenance Plan”)

The SEAT dealership or a specialised workshop records Service receipts in a central system. Thanks to this comprehensive documentation of the service history, it is possible to reproduce the services performed any time. SEAT recommends requesting a Service receipt after every service carried out containing all the services carried out on the system.

Whenever there is a new service the receipt is replaced with a current one.

The Digital Maintenance Plan is not available in some markets. In this case, your SEAT dealer will inform you about the current documentation of the work.

Service works

In the Digital Maintenance Plan, your SEAT authorised service or specialised workshop documents the following information:

- When each one of the services was carried out.
- Whether a specific repair has been suggested, e.g. changing the brake pads in the near future.
- If you have expressed a special request for the maintenance. Your Service Advisor will write the work order.
- The components or fluids that were changed.
- The date of the next service.

The Long Life Mobility Warranty is valid until the next inspection. This information is documented in all checks performed.

The type and the volume of the service may vary from one vehicle to another. A specialised workshop will be able to provide specific information on the jobs for your vehicle.

WARNING

If the services are insufficient or not performed and if the service intervals are not observed, the vehicle may be immobilised in traffic cause an accident and severe injuries.

- **Make sure that any repairs are carried out by a SEAT authorised service or specialised workshop.**

NOTICE

SEAT accepts no liability for any damage to the vehicle caused either by inadequate workshop service or damage resulting from the unavailability of spare parts.

Note

Regular services on the vehicle not only maintain its value, but also its correct operation and road safety. For this reason, conduct the services in accordance with SEAT guidelines.

Set Service or Flexible Service Intervals

Services are classified as **oil change service** and **inspection**. The service interval indicator on the instrument cluster display serves as a reminder of the next service.

Depending on the features, the engine and the usage conditions of the car, either the **Fixed service** or the **Flexible service** will be applied for an oil change service.

How to know which type of service needs to his vehicle

Check the tables below:

Oil change service ^{a)}		
PR No.	Type of service	Service interval
Q11	Fixed	Every 5000 km or after 1 year^{b)}
Q12		Every 7,500 km or after 1 year^{b)}
Q13		Every 10,000 km or after 1 year^{b)}
Q14		Every 15,000 km or after 1 year^{b)}
Q16	Flexible	According to the service interval indicator.

^{a)} The data are based on normal usage conditions.

^{b)} Whatever occurs first.

Inspection Service^{a)}

According to the service interval indicator.

^{a)} The data are based on normal usage conditions.

Particular characteristics of the Flexible Service


Regarding the **Flexible Service** the oil change service only has to be performed when the vehicle needs it. To calculate when you have to carry out this service, take into account the individual usage conditions and personal driving

style. A major component of the flexible service is the use of LongLife oil instead of conventional engine oil.

Bear in mind the information about the specifications of the engine oil according to the VW standard ››› page 275.

If you do not want to perform the flexible service you can select the fixed service. However, a fixed service may affect service costs. The Service Advisor will gladly advise you.

At SEAT, the dates of the services are indicated by the service intervals display:

- on the instrument cluster ››› page 23
- in the infotainment system:  > **Settings** > **Service** menu.

OR:  > **Vehicle status** > **Service** ››› page 36.

The service interval indicator gives information for service dates that involve an engine oil change or an inspection. When the time for the corresponding service comes, additional work required, such as the change of brake fluid and the spark plugs, can be carried out.

Information about the terms of use

The service intervals and groups are usually based on **normal usage conditions**.

If, on the other hand, the vehicle is under **adverse usage conditions**, some of the work must be carried out before the next service period or even between service intervals.

Adverse usage conditions include:

- The use of fuel with a high sulphur content.
- Frequent short trips.
- Letting the engine idle for a long period of time, as in the case of taxis.
- Using the vehicle in areas with thick dust.
- Frequent driving with a trailer (depending on equipment).
- Using the vehicle mostly in situations with a lot of traffic and stops (e.g. in the city).
- Using the vehicle mostly in winter.

This applies especially for the following parts (depending on equipment):

- Dust and pollen filter
- Air Care allergen filter
- Air filter
- Toothed chain
- Particulate filter
- Engine oil

The Service Advisor of your specialised workshop will gladly inform you about the need to perform service work between normal service intervals, always considering the usage conditions of your vehicle.

⚠ WARNING

If the services are insufficient or not performed and if the service intervals are not observed, the vehicle may be immobilised in traffic and cause accidents and severe injuries.

- Have the services conducted at authorised SEAT services or specialised workshops.

ⓘ NOTICE

SEAT cannot be held liable for any damage to the vehicle due to insufficient work or lack of availability of spare parts.

Service packages

Service packages include all the **maintenance works** needed to ensure the safety and the smooth running of the vehicle (**depending on the usage conditions and the features of the vehicle**, such as the engine, gearbox, or operating fluids).

Maintenance services are divided into *inspection and review* services. Consult the details of the jobs required for your vehicle at:

- Your SEAT authorised service
- Your specialised workshop

Due to technical reasons (continuous development of components) the service packages may vary. Your SEAT authorised service or specialised workshop always receives timely updates.

Additional service offers**Approved spare parts**

Original SEAT Spare Parts have been designed for your vehicle and approved by SEAT, with a special emphasis on safety. These parts correspond exactly to the manufacturer's requirements in terms of design, accuracy of the measurements and materials. The original SEAT Spare Parts have been designed exclusively for your vehicle. For this reason, we always recommend the use of Original SEAT Spare Parts. SEAT cannot be held liable for the safety and suitability of parts from other manufacturers.

Approved spare parts

Approved spare parts, following the manufacturer's requirements, are an additional service to you, offering the possibility of replacing complete sets, such as: lightened engine, gearboxes, heads, control units, electrical components, etc.

These parts are, **approved parts**, and are the same as the factory parts, which are also approved spare parts.

Original accessories

We recommend you only use SEAT Original Accessories and SEAT approved accessories for your vehicle. The reliability, safety and suitability of these accessories have been inspected specifically for this type of vehicle. SEAT cannot be held liable for the safety and suitability of parts from other manufacturers.

Service Mobility

As of the moment you purchase your SEAT vehicle you will be able to enjoy the benefits and coverage of Service Mobility.

For the first two years after the purchase, your new SEAT vehicle is automatically covered by Service Mobility at no additional cost.

If you wish to enjoy this service after this period, you can extend SEAT Service Mobility as long as you carry out the recommended Inspection and Maintenance Services at a SEAT Authorised Service.

If your SEAT vehicle is immobilised due to a fault or an accident, our assistance services will help you keep moving.

Take into account that the SEAT Mobility Service differs depending on the country in which the vehicle was purchased. For further information ask your SEAT dealership or the SEAT website in your country.

Vehicle upkeep and cleaning

Basic observations

Regular and careful care helps to maintain the value of your vehicle. In addition, it may become a prerequisite for a warranty claim in the event of corrosion damage and deficiencies in the paint coat of the bodywork.

Specialised workshops have the necessary care products. Please follow the application instructions on the packaging.

WARNING

- Cleaning products and other materials used for car care can be damaging to your health if misused.
- Always keep care products in a safe place, out of the reach of children. Danger of poisoning!

For the sake of the environment

- When purchasing car care products, choose products that are compatible with the environment.
- The waste from car-care products should not be disposed of with ordinary household waste.

Washing the vehicle

The longer you take to clean off deposits, e.g. remains of insects, bird excrements, tree resin or road salt adhered to your vehicle, the more damage it can cause to the surface. High temperatures, for instance strong sunlight, further intensify the damage.

Before washing the car, soften the dirt using plenty of water.

To remove encrusted dirt such as insects, bird droppings or tree resin, use a lot of water and a microfibre cloth.

Have the underside of the vehicle washed after the end of the road salts in winter.

High pressure cleaning equipment

When washing the vehicle with a high-pressure cleaner, always follow the operating instructions for the equipment. This applies particularly to the operating pressure and the distance between the water jet and the vehicle.

Do not aim the jet directly towards the side window seals, doors or covers; the same applies for the tyres, rubber hoses, soundproofing material, radar sensors or camera lenses. Keep a distance of at least 40 cm.

Do not remove snow and ice with a high-pressure cleaner.

Do not use a nozzle that sprays the water out in a direct stream or one that has a rotating jet for forcing off dirt.

The water temperature must not exceed 60°C.

Automatic car washes

Spray the vehicle before starting the car wash.

Make sure that the windows are closed and the windscreen wipers are deactivated. Bear in mind the instructions of the car wash tunnel operator, especially if your vehicle has detachable parts.

Use car washes without brushes if possible.

Washing by hand

Clean your vehicle from top to bottom with a soft sponge or with a brush. Only use cleaning products that do not contain solvents.

Polishing

Polishing is only necessary when the vehicle's paintwork has lost its gloss and cannot be restored with care products.

Do not polish matt painted surfaces! If the paintwork is polished, the surface will be irreparably damaged.

Washing vehicles with matte paintwork

To wash the vehicle, it is best to use a special cleaner for matte paintwork. For further information, please contact an official service centre.

Apply the product by spraying it onto the body-work. Work in one zone at a time and leave the product to act for at least 2 minutes. Wipe it with a microfibre cloth and **avoid placing excessive pressure** on the treated area until the dirt is removed. Once clean, repeat the application of the product area by area and spread it until a uniform finish is achieved.

If the vehicle is affected by mosquitoes or larger amounts of dirt, spray the product on the entire surface, leave it to act for 2 minutes and apply pressurised water until it is completely clean. Once dry, apply the product one zone at a time and spread it with microfibre, **avoiding excessive pressure**, to achieve a uniform finish.

In both cases, the final application cares for the vehicle in an optimal manner and provides a protective layer against dirt and water.

WARNING

- Only wash the vehicle with the ignition switched off or according to the specifications of the car wash tunnel operator. Accident hazard!
- When cleaning the underbody or the inside of the wheel arches, protect yourself from sharp or pointy metal parts. Risk of cuts!

- After cleaning, the brakes could act more slowly due to moisture or, in winter, ice on the brake discs and pads. Accident hazard! In this case the brakes should be dried by pressing the brake pedal several times.

WARNING

Incorrect use of high-pressure cleaning equipment can cause damage. This can lead to accidents and serious injuries.

- Never aim the jet of the high-pressure cleaning equipment directly towards the 12 volt on-board network.

NOTICE

- Before washing the vehicle in an automatic car wash, the exterior mirrors should be folded in to prevent them from being damaged. The electric folding exterior mirrors should only be folded or unfolded electrically!
- Do not wash the vehicle in direct sunlight. Risk of damaging the paint job!
- Do not use sponges, abrasive household sponges or similar to clean insect remains. Risk of damaging the surface!

- Vehicle parts with matte paint:
 - Do not use polish or hard wax. Risk of damaging the surface!
 - Never select washing programmes that include the use of wax. This could damage the appearance of matte paint.
 - Do not put stickers or magnets on parts with matte paint, as removing them may damage the paint.

For the sake of the environment

The car should only be washed in special wash bays. These places are designed to prevent oily water from getting into the public drains.

Cleaning the exterior

Below can be found some recommendations on the cleaning and upkeep of individual vehicle components.

Go to your specialised workshop if you have special questions or parts that are not listed.

Take the general considerations into account
»» page 308, *Take special care with...*

Windscreen wipers

- *Dirt:* Soft cloth with windscreen cleaner.

Headlights / Tail lights

- *Dirt*: Soft sponge with neutral soap solution¹⁾.

Sensors / Camera lenses

- *Dirt*:
 - *Sensors*: soft cloth with a solvent-free cleaning product.
 - *Camera lenses*: soft cloth with an alcohol-free cleaning product.
- *Snow/ice*: Hand brush/Solvent-free antifreeze spray

Wheels

- *Road salt*: Water.
- *Brake abrasion dust*: Special acid-free cleaning product.

Exhaust pipe ends

- *Road salt*: Water, if a fine steel cleaning product is required, or a non-abrasive and non-corrosive cleaning product.

Covers / Trims

- *Dirt*: Neutral soap solution¹⁾, if a fine steel cleaning product is required.

Paint

- *Paint flaws*: Check the paint's colour code at an authorised service and restore with a touch-up pencil.
- *Spilled fuel*: Immediately rinse with water.
- *Environmental rust deposit*: Apply rust remover and then apply hard wax. Go to your specialised workshop if you have any queries.
- *Corrosion*: Have your specialised workshop take care of this.
- *Water does not form droplets on the clean paint*: Maintain with hard wax (at least twice a year).
- *No shine despite maintenance/unattractive paint*: Treat with suitable wax and apply paint preservative afterwards if the wax used does not contain preservative ingredients.
- *Tanks, e.g. insect remains, bird droppings, tree sap, road salt*: Immediately soak with water and remove with a microfibre cloth.
- *Grease-based dirt, e.g. cosmetic products or sunscreen*: Remove immediately with a neutral soap solution¹⁾ and a soft cloth.

Carbon fibre parts

- *Dirt*: Clean in the same way as painted parts
»» page 305.

Decorative laminates

- *Dirt*: Soft sponge with neutral soap solution¹⁾.

Interior cleaning

Below can be found some recommendations on the cleaning and upkeep of individual vehicle components.

Go to your specialised workshop if you have special questions or parts that are not listed.

Take the general considerations into account
»» page 308, *Take special care with....*

Windows

- *Dirt*: Apply windscreen cleaner and then dry with a cloth.

Covers / Trims

- *Dirt*: Neutral soap solution¹⁾.

Plastic parts

- *Dirt*: Damp cloth.
- *Encrusted dirt*: Neutral soap solution¹⁾, if possible a solvent-free plastic cleaning product.

Displays/instrument cluster

- *Dirt*: Soft cloth with a liquid crystal display cleaner.

¹⁾ Neutral soap solution: maximum of two tablespoons in 1 l of water.

Control panels

- *Dirt*: Soft brush, then a soft cloth with a neutral soap solution¹⁾.

Seat belts

- *Dirt*: Neutral soap solution¹⁾, allowed to dry before retracting.

Fabrics, artificial, Alcantara leather

- *Particles of dirt stuck to surfaces*: Vacuum cleaner.

- *Water-based dirt, e.g. coffee, tea, blood etc.*: Absorbent cloth and neutral soap solution¹⁾.

- *Grease-based dirt, e.g. oil, make-up, etc.*:

Apply a neutral soap solution¹⁾. Absorb the dissolved grease and paint particles by drying with an absorbent cloth, if you have to treat it with water afterwards.

- *Special dirt, e.g. pens, nail polish, spray paint, shoe polish, etc.*: Special stain remover: dry with an absorbent cloth, if applicable, apply neutral soap solution afterwards¹⁾.

Natural leather

- *Recent dirt*: Cotton cloth with neutral soap solution¹⁾.

- *Water-based dirt, e.g. coffee, tea, blood etc.*:

- *Recent stains*: absorbent cloth.

- *Dry stains*: stain remover suitable for leather.

- *Grease-based dirt, e.g. oil, make-up, etc.*:

- *Recent stains*: absorbent cloth and suitable stain remover for leather.

- *Dry stains*: grease solvent spray.

- *Special dirt, e.g. pens, nail polish, spray paint, shoe polish etc.*: Stain remover suitable for leather.

- *Care*: Apply preservative cream regularly to protect from sunlight. Use a coloured preservative if required.

Carbon fibre parts

- *Dirt*: Clean as with plastic parts.

Take special care with...

Headlights/tail lights

- Do not clean the headlights/tail lights with a dry cloth or sponge.

- Do not use cleaning products that contain alcohol. Risk of cracks!

Wheels

- Do not use for paint wax or other abrasive products.

- If the protective coating on the paint of the rim has been damaged due to stone impacts, scratches, etc., the damage should be repaired immediately.

Camera lenses

- Do not use hot or warm water to remove ice or snow from the camera lenses. Risk of cracking the lens!

- To clean the camera lens, never use abrasive cleaning products or products with alcohol. Risk of scratches and cracks!

Radar sensors

- Avoid aiming the jet of pressurised water at the radar sensors.

Windows

- Remove snow and ice from windows and exterior mirrors with a plastic scraper only. To avoid scratches, the scraper should only be pushed in one direction and not moved to and fro.

¹⁾ Neutral soap solution: maximum of two tablespoons in 1 l of water.

- Never remove snow or ice from windows and rearview mirrors with warm or hot water. Risk of cracks on the windows!
- To prevent damage to the heating of the rear window, do not put stickers over the heating elements.

Covers/trim

- Do not use cleaning products or chrome based cleaning agents.

Paint

- The vehicle must be free from dirt and dust before applying wax or care products. Risk of scratches!
- Do not apply wax or care products if the vehicle is exposed to direct sunlight. Risk of damaging the paint job!
- The ambient rust deposits must not be removed through friction. Risk of damaging the paint job!
- Remove cosmetic products and sunlight immediately. Risk of damaging the paint job!

Displays/instrument panel

- The displays, the instrument panel and the trim around it must not be cleaned dry. Risk of scratches!

- Make sure that the instrument panel is switched off and cooled down before cleaning.
- Make sure that no liquid leaks between the instrument panel and the trim. Risk of damage!

Control panels

- Make sure that no liquid leaks into the control panels. Risk of damage!

Seat belts

- Do not remove the seat belts to clean them.
- Seat belts and their components must never be cleaned with chemical products, nor should they be allowed to come into contact with corrosive liquids, solvents or sharp objects. Risk of damaging the fabric!
- If you find any damage to the belt webbing, belt fittings, the belt retractor or the buckle, ask your specialised workshop to replace the belt in question.

Fabrics/artificial leather/microfibre

- Do not treat artificial leather/microfibre with leather cleaning products, solvents, wax polish, shoe cream, stain removers or similar products.
- If the stain is very hard to remove, take the vehicle to a specialised workshop to have it removed there. This will prevent damage.
- Do not use steam cleaners, brushes, hard sponges, etc. to clean.
- Do not turn on seat heating to dry the seats.

- Sharp objects on clothing, such as zips, rivets or belts can damage the surface.
- Open Velcro, e.g. on clothes can damage the seat upholstery. Make sure that Velcro fasteners are closed.

Natural leather

- Never use solvents, wax polish, shoe cream, spot removers or similar products on leather.
- Sharp objects on clothing, such as zips, rivets or belts can damage the surface.
- Do not use steam cleaners, brushes, hard sponges, etc. to clean.
- Do not turn on seat heating to dry the seats.
- Avoid exposing leather to direct sunlight for long periods, otherwise it may tend to lose some of its colour. If the car is left for a prolonged period in the bright sun, it is best to cover the leather.

WARNING

Do not use water-repellent coatings on the windscreen. In bad visibility conditions such as humid weather, darkness or when the sun is in its lowest point, visibility may be impacted. Accident hazard! Such coatings can also cause the windscreen wiper blades to make noise.

Note

- Remains of insects can be removed much more easily with previously treated paint.
- Regular car care treatments can prevent deposits of ambient rust.

Taking your vehicle out of service

If you want to leave your vehicle stationary for a long period of time, contact a qualified workshop. They will gladly inform you about the necessary measures, such as anti-corrosion protection, Service and storage.

Also take into account the indications relating to the vehicle's battery >>> page 279 , >>> page 279, Introduction.

Accessories, spare parts and repair work**Introduction**

Always ask your dealer or specialist retailer for advice before purchasing accessories and replacement parts.

Your vehicle is designed to offer a high standard of active and passive safety. For this reason, we recommend that you ask a SEAT Official Service for advice before fitting accessories or replacement parts. Your SEAT Official Service has the latest information from the manufacturer

and can recommend accessories and replacement parts which are suitable for your requirements. They can also answer any questions you might have regarding official regulations.

We recommend only using **SEAT accessories** and **genuine SEAT parts**[®]. SEAT has tested these parts and accessories for suitability, reliability and safety. SEAT Official Services have the necessary experience and facilities to ensure that the parts are installed correctly and professionally.

Although SEAT continuously monitors the market, it cannot judge whether products **not authorised by SEAT** meet the vehicle's reliability, safety and suitability requirements. SEAT therefore accepts no liability for these products, even if, in certain cases, they are authorised by an officially recognised technical inspection institute or official body.

Any **retrofitted equipment** which has a direct effect on the vehicle and/or the way it is driven, such as a cruise control system or **electronically-controlled suspension**, must be approved for use in your vehicle and bear the **e** mark (the European Union's authorisation symbol).

If **any additional electrical devices** are fitted which do not serve to control the vehicle itself (for instance a refrigerator box, laptop or ventilator fan, etc.), they must bear the **CE** marking (manufacturer conformity declaration in the European Union).

WARNING

Accessories, for example telephone holders or drink holders, should never be fitted on the covers, or inside the operating range of the airbags. Otherwise, there is a danger of injury if the airbag is triggered in an accident.

Technical modifications

Unauthorised modifications to the electronic components, software, wiring or data transfer in the vehicle may cause malfunctioning.

We request your understanding that your SEAT dealership cannot be held liable for any damage caused by modifications and/or work performed incorrectly.

For this reason we recommend asking SEAT official service centres to do any necessary work using **genuine SEAT parts**[®].

WARNING

Incorrectly performed modifications or other work on your vehicle can lead to malfunctions and cause accidents.

Radio telephones and office equipment

Radio transmitters (fixed installation)

Any retrofit installations of radio transmitters in the vehicle require prior approval. SEAT generally authorises in-vehicle installations of approved types of radio transmitters provided that:


- The antenna is installed correctly.
- The aerial is installed on the exterior of the vehicle (and shielded cables are used together with non-reflective aerial trimming).
- The effective transmitting power does not exceed 10 Watts at the aerial base.

A SEAT Official Service and specialised workshop will be able to inform you about options for installing and operating radio transmitters with a higher transmitting power.

Mobile radio transmitters

Commercial mobile telephones or radio equipment might interfere with the electronics of your vehicle and cause malfunctions. This may be due to:

- No external aerial.
- External aerial incorrectly installed.
- Transmitting power more than 10 W.

Therefore you must not operate portable mobile telephones or radio equipment *inside the vehicle* without a properly installed external aerial »» .

Please note also that the maximum range of the equipment can only be achieved with an *external* aerial.

Business equipment

Retrofit installation of business or private equipment in the vehicle is permitted, provided the equipment cannot interfere with the driver's immediate control of the vehicle and that any such equipment carries the CE mark. Any retrofit equipment that could influence the driver's control of the vehicle must have a type approval for your vehicle and must carry the e mark.

WARNING

Mobile telephones or radio equipment which is operated inside the vehicle without a properly installed external aerial can create excessive magnetic fields that could cause a health hazard.

Note

- **Retrofitting electric and electronic equipment in this vehicle affects its licence and could lead to the withdrawal of the vehicle registration document under certain circumstances.**
- **Please follow the mobile telephone/radio operating instructions.**

User information

Warranty

Fault-free operation warranty

SEAT Authorised Services ensure the perfect condition of new vehicles. Check the purchase agreement or complementary additional documentation provided by your Technical Service for the conditions and terms of the warranty. Get further information about this from your SEAT Official Service.

Information stored by the control units

Storage of accident data (Event Data Recorder)

Your vehicle has an event data recorder (EDR). The EDR's function is to record data in the event of a mild or serious accident. These data are used to support the analysis of how different vehicle systems behaved.

The EDR records, over a reduced time range (normally 10 seconds or less), dynamic driving data and data from the restraint systems, such as:

- How different vehicle systems worked.
- Whether the driver and the occupants were wearing their seat belts.
- How hard the accelerator or brake pedal was pressed.
- Vehicle speed.

These data will provide a better understanding of the circumstances of the accident.

Data from the driving assist systems are also recorded. This includes data such as whether the systems were inactive or active and if such action had an impact on the vehicle's dynamic behaviour, changing its path in the aforementioned situations, or accelerating or decelerating the vehicle.

Depending on vehicle equipment, this includes data from systems such as:

- the adaptive cruise control
- the lane assist system
- the park assist systems
- the emergency brake functions.

The EDR data are only recorded in specific accident situations. No data are recorded in normal driving conditions.

No audio or video data inside or around the vehicle are recorded. Under no circumstances are personal data such as name, age, or gender recorded. Nevertheless, third parties (such as criminal proceedings authorities) may relate

the contents of the EDR data to other data sources and create a personal reference in the context of an accident investigation.

In order to read the EDR data it is necessary to access (if legally permitted to do so) the vehicle's ODB ("On-Board-Diagnose") interface while the vehicle is switched on.

In addition to the vehicle manufacturer, third parties, such as judicial organisations with the appropriate tools, may be able to access the information if they have access to the vehicle or to the data recorded in the EDR.

SEAT will not have access to EDR data unless the owner (or, in "Leasing" cases, the lessee or hirer) gives their consent. There may be exceptions to this, depending on legal or contractual provisions.

Due to legal requirements in safety-related products, SEAT may use the EDR data for field research and in order to improve vehicle system quality. Any data used for research purposes will be treated anonymously (in other words, no reference will be made to the vehicle, its owner or the lessee/hirer).

Vehicle antennas

Infotainment system and antennas

The infotainment system's antennas are installed on different locations on the vehicle:

- On the roof.
- On the windscreen, between the layers of glass.
- On the rear and side windows with a printed antenna structure >>> ⓘ.

! NOTICE

The printed antenna structure on the rear and side windows can be damaged by objects rubbing against it or by the use of corrosive products, or products containing acids.

- Do not apply any stickers to the rear and side window areas.
- Never clean the antenna structure with corrosive or acidic products.

Fluids in the air conditioning system

Refrigerant in the air conditioning system

The label in the front compartment provides information on the type and amount of refrigerant used in the vehicle's air conditioning system. The label is located at the front of the front compartment, near the refrigerant filling valves >>> ⚠.

Detailed information on the refrigerant used

If the refrigerant type indicated on the label is R1234yf, the air conditioning system contains fluorinated gases.

If the type of refrigerant is R744, this gas does not contain fluorinated gases.

Type of refrigerant	R1234yf
Refrigerant weight	390 g
	430 g
CO ₂ equivalent	0.0002 t
	0.0002 t
Global warming potential	0.501

Refrigerant oil in the air conditioning

The air conditioning system is filled with a refrigerant oil. For information on the type and amount of refrigerant oil used, contact a qualified specialist company.

SEAT recommends a SEAT official service.



Warning: Maintenance of the air conditioning system must be performed by qualified specialists.



Type of refrigerant.



Type of refrigerant oil



Refer to the workshop information (available only at SEAT official services).



Maintenance of the air conditioning system must be performed by qualified specialists.



Flammable refrigerant.



Ensure all components are properly disposed of. Do not install components removed from end-of-life vehicles or recycled components in your vehicle.

⚠ WARNING

Maintenance of the air conditioning system by unqualified personnel can cause serious and fatal injuries.

- For air conditioning system maintenance, contact qualified personnel trained according to the required country standards, such as the standard SAE J2845.
- Bear in mind the service intervals recommended by SEAT. For this, contact a qualified specialist company. SEAT recommends a SEAT official service.

⚠ WARNING

The refrigerant is flammable and can cause serious and fatal injuries if not properly maintained.

The refrigerant is under pressure and can explode when heated. This can cause serious and fatal injuries.

The refrigerant can form toxic vapours when it comes into contact with hot surfaces. If inhaled, they can cause poisoning or even death.

- Have the air conditioning system repaired by qualified personnel.
- Keep the vehicle away from flames, sparks, or other sources of ignition.

ⓘ NOTICE

Repair or replacement of the evaporator with spare parts from end-of-life vehicles or recycling can damage the air conditioning system.

- Never have the evaporator repaired with spare parts from end-of-life vehicles or recycling.

Information on the EU chemicals regulation REACH

In accordance with the European Chemicals Regulation REACH, SEAT, S.A. has information on the substances that may be contained in the vehicle.

You can ask any SEAT dealer for this information.

Materials and recycling information

Environmental compatibility

Environmental protection is a top priority in the design, choice of materials and manufacture of your new SEAT.

Constructive measures to encourage recycling

- Joints and connections designed for easy dismantling.
- Modular construction to facilitate dismantling.
- Increased use of single-grade materials.
- Plastic parts and elastomers are marked in accordance with ISO 1043, ISO 11469 and ISO 1629.

Choice of materials

- Use of recycled materials.
- Use of compatible plastics in the same part if its components are not easily separated.
- Use of recycled materials and/or materials originating from renewable sources.
- Reduction of volatile components, including odour, in plastic materials.
- Use of CFC-free coolants.

Ban on heavy metals, with the exceptions provided for by law (Annex II of ELV Directive 2000/53/EC): cadmium, lead, mercury, hexavalent chromium.

Manufacturing methods

- Reduction of the quantity of thinner in the protective wax for cavities.
- Use of plastic film as protection during vehicle transport.
- Use of solvent-free stickers.
- Use of CFC-free coolants in cooling systems.
- Recycling and energy recovery of waste (RDF).
- Improvement in the quality of waste water.
- Use of systems for the recovery of residual heat (thermal recovery, enthalpy wheels, etc.).
- The use of water-soluble paints.

Recycling of electrical or electronic devices

All electrical or electronic devices (EED) that are not permanently fitted in the vehicle must be marked with the following symbol:



This symbol indicates that EED must not be discarded as home waste but through selective waste collection.

Product recycling

✓ Valid for market: France



Fig. 202 Recycling notice for France.

Please note the recycling instructions in >>> **Fig. 202** for the following items:

- Vehicle keys
- Remote control of auxiliary heating and ventilation.

- Compressor.
- Charging cable.
- Mobile key card.



Fig. 203 Fire extinguisher recycling notice for France.

Please note the recycling instructions in >>> **Fig. 203** for the following items:

- Extinguishers.



Fig. 204 Recycling notice for France.



Fig. 205 Recycling notice for France.

Please observe the recycling instructions >>> **Fig. 204**, >>> **Fig. 205** for documentation and packaging or bags of the following items:

- Maintenance manual.
- First aid kit.
- Extinguishers.
- Compressor.
- Charging cable.
- Charging socket and watertight seal.
- Vehicle toolbox.
- Puncture repair spray.
- Jack.
- Warning triangle.
- High visibility jacket.
- Tool bag.



For the sake of the environment

The Triman logo and the Info-tri symbol contain important classification information for the end user.

Product recycling

✓ Valid for market: Italy

Environmental labelling

Legislative decree no. 116 [3 September 2020], which transposes EU Directive 2018/851 on waste, and EU Directive 2018/852 on packaging and packaging waste, states that all packaging must be properly labelled to facilitate the collection, reuse, recovery and recycling of packaging, and to give users correct information about the final destination of the packaging.

Information about the environmental labelling of packaging present in the vehicle can be accessed by scanning the following QR code, which links to a website where the information required by this regulation can be found:



Return and scrapping of end-of-life vehicles

End-of-life return

At the end of its useful life, your vehicle must be recycled and disposed of in an environmentally sound manner. For this reason, final vehicle owners in the EU and in many other countries are required by law to take their vehicle to an authorised collection point, vehicle return centre or authorised dismantling facility.

SEAT already made the necessary arrangements for this: an extensive network of vehicle return centres is available throughout the EU and in many other countries, where you can drop off your vehicle. If you meet the national legal requirements, you can return your end-of-life vehicle free of charge within the EU.

The vehicle return centre issues a recycling certificate which serves as proof that the end-of-life vehicle has been recycled correctly.

Information about the Vehicle Return Centres can be obtained from your SEAT dealer.

Scrapping

The relevant safety requirements must be observed when scrapping the vehicle or its individual components, e.g. airbag system and seatbelt tensioners. Qualified workshops are already familiar with these requirements. SEAT recommends using a SEAT dealer.

Declaration of conformity

Commercialisation of finished products on the British market (England, Wales and Scotland):

**UK
CA**

The UKCA (UK Conformity Assessed) marking is a new British marking used for products commercialised in Great Britain (England, Wales and Scotland).

Importer:

Volkswagen Group United Kingdom Ltd.
Yeomans Drive, Blakelands
Milton Keynes, MK 14 5AN
United Kingdom

Vehicles commercialised on the British market by the importer mentioned above may include complete products that comply with the following provisions:

- The Electromagnetic Compatibility Regulations, 2016
- The Electrical Equipment (Safety) Regulations, 2016
- The Supply of Machinery (Safety) (Amendment) Regulations, 2011
- The Noise Emission in the Environment by Equipment for use Outdoors Regulations, 2001
- The Restriction of the Use of Certain Hazardous Substances in Electrical and Electronic Equipment Regulations, 2012

- The Medical Devices Regulations, 2002 (SISI 2002, no. 618, in its amended version) (UK MDR 2002)
- The Pressure Equipment (Safety) Regulations, 2016
- The Personal Protective Equipment (Enforcement) Regulations, 2018

Note

For medical devices, the CE marking will remain valid in the UK until 30 June, 2023.

In accordance with the aforementioned regulations, the importer has ensured that:

The manufacturer has performed the corresponding conformity assessment, has drawn up the technical documentation and meets the market requirements.

Note

Until 31 December 2025, the British market may be placed on a label that is affixed to the product or the attached documentation.

Radioelectrical equipment

Simplified declaration of conformity

Your vehicle has different radioelectrical devices. The manufacturers of these devices declare that they comply with Directive 2014/53/EU when legally required.

The full text of the EU compliance declaration is available online at the following website:

www.seat.com/generalinfo



United Kingdom

Your vehicle has different radioelectrical devices. The manufacturers of these devices declare that they comply with the UK Radio Equipment Regulations 2017 (SI 2017/1206) if required by law.

The full text of the declaration of conformity is available online at the following website:

www.seat.com/generalinfo



Ukraine

Your vehicle has different radioelectrical devices. The manufacturers of these devices declare that they comply with Ukraine Decree 355/2017 (TR Radio Equipment) where legally required.

The full text of the declaration of conformity is available online at the following website:

www.seat.com/generalinfo



Addresses of the manufacturers

The address of the manufacturers of components that, due to their size or nature, cannot include a sticker are listed below, as long as it is legally required:

Central control unit (BCM)

Robert Bosch GmbH/Braunschweig
Theodor-Heuss-Strasse 12
38122 - Braunschweig, Germany
Phone: 0049 53188890

Keyless Access system and key with radio remote control of the central locking system

HELLA GmbH & Co. KGaA/Hamm
Roemerstr. 66
59075 - Hamm, Germany
Phone: 0049 23817980

Roof antenna

ASK Industries S.p.A
Via dell'Industria n.12/14/16
60037 Monte San Vito (AN), Italy
Phone: +3907174521
Website: www.askgroup.it

Mitsumi Electronics Europe GmbH
Siemensstrasse 32
63225 Langen, Germany
Phone: +49 (0) 6103913-0
Website: www.minebeamitsumi.co.jp

Molex CVS Hildesheim GmbH
Daimlerring 31
31135 Hildesheim, Germany
Phone: +49 3377 3160
Website: www.molex.com

Antenna amplifiers

ASK Industries S.p.A
Via dell'Industria n.12/14/16
60037 Monte San Vito (AN), Italy
Phone: +3907174521
Website: www.askgroup.it

Hirschmann Car Communication GmbH
Stuttgarter Strasse 45-51
72654 Neckartenzlingen, Germany
Phone: +49 7127 140
Website: www.te.com

KATHREIN Automotive GmbH
Römerring 1
31137 Hildesheim, Germany
Phone: +498,031,184-0
Website: www.kathrein.com

Molex CVS Hildesheim GmbH
Daimlerring 31
31135 Hildesheim, Germany
Phone: +49 3377 3160
Website: www.molex.com

Navigation antenna

Hirschmann Car Communication GmbH
Stuttgarter Strasse 45-51
72654 Neckartenzlingen, Germany
Phone: +49 7127 140
Website: www.te.com

KATHREIN Automotive GmbH
Römerring 1
31137 Hildesheim, Germany
Phone: +498,031,184-0
Website: www.kathrein.com

Connectivity Box

Molex CVS Dabendorf GmbH
Märkische Strasse 72
15806 Zossen OT Dabendorf, Germany
Phone: +49 3377 3160
Website: www.molex.com

Molex Technologies GmbH
Mizarstraße 3, 12529 Schönefeld
Website: www.molex.com

Strona główna - BURY
ul. Wojska Polskiego 4
39-300 Mielec, Polska
info@bury.com
+48 17 78846-00

Basic infotainment system

Panasonic Automotive Systems Czech
U Panasonicu 266
530 06, Pardubice, Czech Republic

Optional infotainment system

LG Electronics Mława SP
LG Electronics 7
06 500, Mława

Radio remote control of the auxiliary heating

Digades GmbH Digitales Und Ana/Zittau
Äußere Weberstr. 20
02763 - Zittau, Germany
Phone: 0049 358357750

Instrument panel

FPK (digital)
Continental Automotive GmbH
VDO-Strasse 1,
64832 Babenhausen, Germany

Panasonic Automotive Systems Europe GmbH
Robert Bosch Str. 27-29
63225 Langen, Germany

Panasonic Automotive Systems Czech, s.r.o.
U Panasonicu 266
530 06, Pardubice, Czech Republic

Front radar sensors

MRR for Leon
Robert Bosch GmbH
Markwiesenstrasse, 46
72770 Reutlingen (Kusterdingen) Germany

MRR for Ateca, Ibiza, Arona
Automotive Distance Control Systems GmbH
Peter-Dornier-Strasse, 10
88131, Lindau, Germany

Rear radar sensors

Hella GmbH & Co. KGaA
Rixbecker Straße 75
59552 Lippstadt (Germany)

Online Connectivity Unit

LG ELECTRONICS INC.
10, Magokjungang 10-ro,
Gangseo-gu, Seoul, Republic of Korea

Radio equipment, frequency band, maximum transmitting power

Below can be found details of the radio equipment¹⁾ that may be fitted to the SEAT models.

Frequency band	Max. station power
Key with radio-operated remote control (vehicle)	
433.05-434.78 MHz	10 mW (ERP)
433.05-434.79 MHz	10 mW
434.42 MHz	32 µW
Radio-operated remote control (auxiliary heater)	
868.7-869.2 MHz (869.0 MHz)	25 mW

Transmitter-Receiver (auxiliary heater)

868.7-869.2 MHz (869.0 MHz)	23.5 mW
-----------------------------	---------

Bluetooth®

2400-2483.5 MHz	10 dBm
-----------------	--------

Connection to the vehicle's external antenna

GSM 900: 880-915 MHz	33 dBm
----------------------	--------

GSM 1800: 1710-1785 MHz	30 dBm
-------------------------	--------

WCDMA FDD I: 1920-1980 MHz	21 dBm
----------------------------	--------

WCDMA FDD III: 1710-1785 MHz	21 dBm
------------------------------	--------

WCDMA FDD VIII: 880-915 MHz	21 dBm
-----------------------------	--------

LTE FDD1: 1920-1980 MHz	23 dBm
-------------------------	--------

LTE FDD3: 1710-1785 MHz	23 dBm
-------------------------	--------

LTE FDD7: 2500-2570 MHz	23 dBm
-------------------------	--------

LTE FDD8: 880-915 MHz	23 dBm
-----------------------	--------

LTE FDD20: 832-862 MHz	23 dBm
------------------------	--------

Band 78 TDD: 3300-3800 MHz	23 dBm
----------------------------	--------

Auxiliary antenna for Car2X

5855-5925 MHz	2 W PIRE
---------------	----------

Wireless hotspot

2400-2483.5 MHz	10 dBm
-----------------	--------

Keyless Access

434.42 MHz	32 µW
------------	-------

125 kHz	89 dBµA/m ^{a)}
---------	-------------------------

^{a)} Valid for market: Ukraine

Radar sensors for front assist systems

76 GHz-77 GHz	30.49 dBm ^{a)}
---------------	-------------------------

34.9 dBm ^{b)}

^{a)} Valid for: Leon

^{b)} Valid for: Ateca, Ibiza, Arona

Radar sensors for rear assist systems

24050-24250 MHz	20 dBm
-----------------	--------

Wireless charging function

110-120 kHz	10 W
-------------	------

Instrument cluster

125 kHz	40 dBµA/m
---------	-----------

¹⁾ The commissioning or authorisation of radioelectrical technology may be restricted in some European countries, forbidden or only allowed with additional requirements.

Online Connectivity Unit

EGSM900: 880-915 MHz	33 dBm
DCS1800: 1710-1785 MHz	31 dBm
UMTS FDD 1: 1920-1980 MHz	24 dBm
UMTS FDD 3: 1710-1785 MHz	24 dBm
UMTS FDD 8: 880-915 MHz	24 dBm
E-UTRA FDD 1: 1920-1980 MHz	23.5 dBm
E-UTRA FDD 3: 1710-1785 MHz	23.0 dBm
E-UTRA FDD 7: 2500-2570 MHz	23.5 dBm
E-UTRA FDD 8: 880-915 MHz	23.0 dBm
E-UTRA FDD 20: 832-862 MHz	23.5 dBm
E-UTRA FDD 28: 703-748 MHz	23.0 dBm

Additional information for countries outside the European Union**Mexico**

Your vehicle has different radioelectrical devices. The manufacturers of these devices declare that they comply with Directive RLVCOAR15-0008 when legally required. The full text of the declaration of conformity is available online at the following website.

www.seat.mx/servicio/mi-seat/manuales-seat

Certificate: RLVHERS17-0286. RS4 Hella KGaA Hueck & Co. short-range radar
IFT:RLVHERS17-0286. The operation of this

equipment is subject to the following two conditions: (1) this equipment or device may not cause harmful interference, and (2) this equipment or device must accept any interference, including interference that may cause undesired operation.

United Kingdom

The following applies to importers in the UK market:

Volkswagen Group United Kingdom Ltd.
Yeomans Drive, Blakelands
Milton Keynes, MK 14 5AN
United Kingdom

Turkey

Telsiz Ekipmanları Yönetmeliği (2014/53/AB)

Aracınızda çeşitli telsiz ekipmanları bulunmaktadır.

Telsiz Ekipmanları Yönetmeliği (2014/53/AB) açısından Türkiye pazarı için radyo ekipmanı ithalatçısı (bu bilgi sadece resmi temsilcimiz olan Doğu Otomotiv Servis ve Ticaret A.Ş.'nin ithal ettiği ürünler için geçerlidir):

Doğu Otomotiv Servis ve Ticaret A.Ş.
Şekerpınar Mahallesi, Anadolu Caddesi, No: 22
ve 45
41420 Çayırova/Kocaeli

Ukraine

Імпортер:

ТОВ «Порше Україна»
просп. Павла Тичини, 1В, офіс „В”, 4-й поверх
02152 Київ, Україна.

Importer:

Porsche Ukraine LLC
Pavla Tychyny ave. 1V, Office "B", 4th floor
02152 Kyiv, Ukraine.

Technical data

Indications about the technical data

Vehicle identification data

The values indicated in the technical data may differ depending on optional equipment or version of the model, as well as in the case of special vehicles and equipment for certain countries.

The information in the official vehicle documentation takes precedence at all times.

Abbreviations used in the Technical Specifications section

kW	Kilowatt, engine power measurement.
PS	Horsepower (not currently used), engine power measurement unit.
rpm, 1/min	Revolutions per minute – engine speed.
Nm	Newton metres, unit of engine torque.
CZ	Cetane number, indication of the diesel combustion power.
RON	Research octane number, indication of the knock resistance of petrol.

Vehicle Identification Number (VIN)

The vehicle ID number can be found in the following places:

- In the infotainment system using the function button **Vehicle > Settings > Service**.
- Front, visible through the small window on the lower left side of the windscreen.
- On the vehicle's data label.
- To the right in the engine compartment.

Type plate

The type plate is located on the vehicle's right hand door frame. Vehicles for certain export countries do not have a type plate.

Performance

The values apply only to optimal road and weather conditions.

The vehicle's performance has been calculated without any equipment that would affect it, e.g. accessories.

Fuel consumption

Approved consumption values are derived from measurements performed or supervised by certified EU laboratories, according to the legislation in force at the time [for more information, see the Publications Office of the European Union on the EUR-Lex website: © European Union, <http://eur-lex.europa.eu/>] for the specified vehicle characteristics.

The values relating to fuel consumption and CO₂ emissions can be found in the documentation provided to the purchaser of the vehicle at the time of purchase.

Fuel consumption and CO₂ emissions depend on the equipment/features of each individual vehicle, as well as on the driving style, road conditions, traffic conditions, environmental conditions, load or number of passengers.

Tank level

Petrol engines	40 l, 7 l reserve
----------------	-------------------

Weights

The kerb weight values apply to a vehicle that is ready to drive with a driver (75 kg), operating fluids and, if applicable, tools and the spare wheel. The kerb weight increases with optional equipment and retrofitting of accessories, which reduce the possible payload accordingly.

Load on the roof

The maximum authorised load on the roof of your vehicle is 75 kg.

Trailer weight

The maximum permitted drawbar load on the ball head of the towing bracket is **55 kg**.

WARNING

The values indicated for the maximum permitted weights must not be exceeded. There is a risk of accident and damage!

Engine specifications

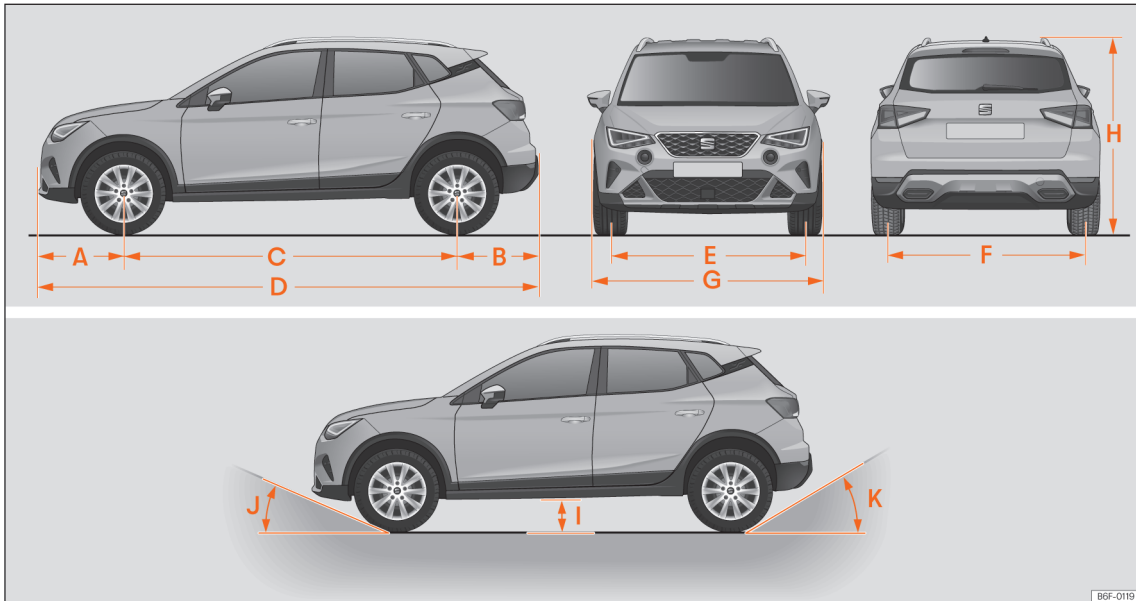
Petrol engines	1.0 TSI Start-Stop		
Power output in kW (hp) at 1/min	70 (95)/5,000-5,500	85 (116)/5,500	
Maximum torque (Nm at 1/min)	175/1,600-3,500	200/2,000-3,500	
No. of cylinders/displacement (cm ³)	3/999	3/999	
Fuel	Super 95 / Normal 91 (with a slight power loss) ROZ		
Gearbox / traction	manual / front	manual / front	DSG / front
Top speed (km/h)	182 (V)	193 (V)	190 (VI)
Acceleration from 0-100 km/h (s)	11.3	10.0	10.3
Maximum authorised weight (kg)	1,710 ^{a1}	1,720 ^{a1}	1,740 ^{a1}

^{a1} Varies depending on the equipment.

Petrol engines	1.5 TSI Start-Stop	1.6 MPI	
Power output in kW (hp) at 1/min	110 (150)/5,000-6,000	81 (110)/5,800	
Maximum torque (Nm at 1/min)	250/1,500-3,500	152/3,850-4,100	
No. of cylinders/displacement (cm ³)	4/1,498	4/1,598	
Fuel	Super 95 / Normal 91 (with a slight power loss) ROZ		
Gearbox / traction	DSG / front	manual / front	automatic / front
Top speed (km/h)	210 (V)	180 (IV)	180 (IV)
Acceleration from 0-100 km/h (s)	8,4	11.2	11.6
Maximum authorised weight (kg)	1,770 ^{a1}	1,690 ^{a1}	1,730 ^{a1}

^{a1} Varies depending on the equipment.

Dimensions.



BGF-0119

Fig. 206 Dimensions and angles.

Dimensions.

		ARONA
A	Front projection (mm)	809
B	Rear projection (mm)	779
C	Wheelbase (mm)	2,566
D	Length (mm)	4,154
E	Front ^{a)} track (mm)	1,513
F	Rear ^{a)} track (mm)	1,495
G	Width (mm)	1,780
H	Height at kerb weight (mm)	1,537 ^{b)}
I	Ground clearance between the axles (mm)	173
J	Front projection angle limited by the bumper	maximum 18.1°
K	Rear projection angle limited by the bumper	maximum 28.1°
	Turning radius (m)	10.6

^{a)} This data will change depending on the type of wheel rim.

^{b)} Dimension to the roof bars.

Index

Numbers and Symbols

12-volt battery	279
assisted start	253
charge level	282
charging	280
control lamps	282
disconnect and connect	280
electrolyte level	280
energy management	282
replacement	280

A

ACC	143
Accessories	310
Activating SEAT CONNECT.	186
Adapting the playback volume	202
Adaptive Cruise Control	143
control and warning lamp	148
malfunction	148
operation	144
special driving situations	146
status display	144
System limitations	146
Adjust	
date and time	23
front seats	84
headrest	85
lights	93
seats	38
Adjusting the seat belt	44

Air conditioning	102	Anti-trap function	
air recirculation	106	windows	81
controls	104	Antifreeze	270
manual air conditioning	105	Apple CarPlay	
refrigerant oil	313	disconnecting	193
troubleshooting	107	establish connection	193
vehicle fluids	313	menu	192
Air recirculation	106	requirements	192
Airbag system	46	special characteristics	193
activation	48	Applications (apps)	192
control lamp	48	Approved spare parts	304
deactivation of the front airbag	50	Aspects to think about before starting the vehicle	
description	47		37
front airbags	49	Assistance call	63
how it works	48	Assistance systems	
Airbags	46	adaptive cruise control	143
activating and deactivating	50	connecting	135
description	47	cruise control	139
for the head	52	drowsiness monitor	24
front	49	emergency braking (Front Assist)	148
side	50	front camera	137
Android Auto™		front radar	136
disconnecting	194	general notes	135
establish connection	194	lane departure warning (Side Assist)	156
menu	193	parking aid Plus	162
requirements	193	rear camera	139
special characteristics	194	rear parking aid	166
Anti-lock system	132	rear radar	137
Anti-puncture	298	road signs detection system	27
Anti-puncture kit	298	safety advice	135
Anti-puncture set	298	speed limiter	141
Anti-theft alarm	74	switching off	135
interior monitoring and anti-tow system	75	system limits	135
trailer	235	Travel Assist	153
Anti-theft alarm system	74	tyre pressure monitor indicator	297

- tyre pressure monitoring 298
 - ultrasound sensors 138
 - Assisted start 253
 - Audible warning
 - lights 89
 - unbuckled seat belt 41
 - Audio warning signals
 - warning and control lamps 11
 - Auto Lock (central locking) 70
 - Auto Unlock 70
 - Automatic car wash 305
 - Automatic dipped beam headlight control 88
 - Automatic gearbox
 - control lamp 121
 - downhill assistant 127
 - driving tips 124
 - ignition key extraction lock 113
 - selector lever positions 121
 - steering wheel with shift paddles 123
 - tiptronic 123
 - Average fuel consumption 16
- B**
- Backrest of the rear seat
 - folding 84
 - raise 84
 - Bag hooks 180
 - Battery 67
 - Before starting the vehicle 37
 - Belt force limiter 45
 - Belt tightening 45
 - Bicycle carrier
 - fitting onto the coverable tow hook 240
 - max. load rating 240
 - Blown bulbs
 - change a bulb 262
 - Bonnet
 - opening and closing 269
 - Brake fluid 273
 - Brakes 130
 - brake fluid 273
 - brake servo 130
 - braking assistant 132
 - new brake pads 130
 - Braking assistant 132
 - Braking system
 - warning lamp 131
 - Brands 203
 - Break recommendation
 - see Drowsiness monitor 24
- C**
- Camera
 - cleaning the vehicle 28
 - Catalytic converter 248
 - Central locking 70
 - anti-theft alarm 74
 - auto-locking due to involuntary opening 70
 - central locking button 72
 - emergency lock 77
 - Keyless Access system 68
 - remote control key 71
 - Change a bulb 262
 - tail light bulb in the bodywork 264
 - Change the wiper blades 251
 - Changing a wheel 291
 - raise the vehicle 295
 - subsequent work 297
 - wheel nuts 294
 - Changing parts 310
 - Changing the battery
 - of the vehicle key 67
 - Check lists
 - requirements for Android Auto™ 193
 - requirements for Apple CarPlay 192
 - Child lock
 - electric windows 79
 - Child seats
 - attachment systems 55
 - group classification 53
 - i-Size 56
 - ISOFIX 56
 - safety instructions 54
 - securing with the seat belt 59
 - Top Tether system 59
 - Cleaning
 - high pressure cleaning equipment 305
 - special care 308
 - vehicle exterior 306
 - vehicle interior 307
 - washing the vehicle 305
 - Clocks
 - set the time 23
 - Closing 70
 - bonnet 269
 - windows 79
 - Clutch (lamp) 126
 - Coming Home 92
 - Connectivity
 - WLAN access point 190
 - Contact 113
 - Control and warning lamps
 - 12-volt battery 282
 - ACC 148
 - adaptive cruise control 144
 - air conditioning 107
 - airbag system 48
 - airbags 50

- anti-lock brake system ABS 133
 - automatic gearbox 121
 - braking system 131
 - cruise control 140
 - cruise control (GRA) 139
 - electromechanical steering 128
 - emissions control 249
 - engine coolant 18
 - engine management 249
 - engine oil 278
 - ESC 133
 - ESC in Sport mode 133
 - ESC off 133
 - fuel reserve 17
 - Lane Assist 152, 153
 - lane departure warning (Side Assist) 157
 - lights 88
 - particulate filter 249
 - press on the brake 143
 - refuelling 17, 246
 - seat belt 41
 - speed limiter 142
 - Start-Stop 118
 - steering column 128
 - TCS 133
 - tyre pressure monitor system 298
 - Controls on the steering wheel 82
 - Cooling 102
 - Cooling system
 - check the coolant 272
 - refilling coolant 272
 - Copyright 203
 - Cornering light 89
 - Correct position 38
 - driver 38
 - passenger 39
 - Cruise control 139
 - Cruise control system 139
 - control lamps 140
 - operating 140
 - Current documentation attached 195
- D**
- Dangers of not using the seat belt 42
 - Data label 321
 - Data transfer 184
 - Deactivating SEAT CONNECT services 188
 - Deactivation of the front airbag 50
 - Disposal
 - seat belt tensioners 46
 - Door cylinder 76
 - Door handle 76
 - Door lock 76
 - Doors 75
 - child lock 77
 - Downhill assistance function 127
 - downhill assistant 127
 - Download
 - over-the-air updates 183
 - Drawers 179
 - Drink holder
 - bottle holder 179
 - front 179
 - in the rear central armrest 179
 - Drive profile 130
 - Drive Profiles
 - see Drive profile selection 129
 - Driving
 - driving on flooded roads 112
 - economical 109
 - loaded vehicle 111
 - safe 37
 - trips abroad 93, 113
 - with the luggage compartment open 111
 - with trailer 238
 - Driving data display 21
 - Driving data 21
 - Driving mode 130
 - Driving on flooded roads 112
 - Driving with a loaded vehicle 111
 - Driving with the luggage compartment open .. 111
 - Drowsiness monitor 24
 - settings 25
 - system limits 25
 - troubleshooting 26
 - warning levels 26
 - DSG 121
 - Duplicate keys 66
 - Dust and pollen filter 102
 - Dynamic headlight range control 93
- E**
- e-Call 65
 - E10
 - see Ethanol (fuel) 248
 - Eco-driving notes 142
 - Electric devices 180
 - Electric windows 79
 - Electrolyte 280
 - Electronic differential lock 132
 - Electronic immobilizer 117
 - Electronic Stability Control (ESC) 132
 - Emergencies 62
 - anti-puncture kit 298
 - changing a wheel 291
 - changing the battery 280
 - emergency vehicle towing 255
 - hazard warning lights 61

- jump leads 253
 - replace a blown fuse 260
 - vehicle tool kit 251
 - Emergency brake assistance system (Front Assist)
 - 136
 - activating and deactivating 150
 - status display 149
 - system limitations 150
 - temporarily deactivating 151
 - warnings 149
 - Emergency braking warning 62
 - Emergency call 63, 65
 - Emergency call service 65
 - Emergency locking of the front passenger door 77
 - Emergency opening
 - driver's door 76
 - rear lid 79
 - Emergency operation
 - front passenger door 77
 - Emissions control system
 - catalytic converter 248
 - control lamp 249
 - particulate filter 249
 - Energy management 282
 - Engine
 - noise 116
 - preheating 113
 - running in 112
 - Start-Stop system 118
 - starting 113
 - Engine and ignition
 - emergency start 118
 - preheat the engine 116
 - starting the engine 116
 - starting the engine with Press & Drive 116
 - switching off the engine 116
 - Engine compartment
 - battery 279
 - engine oil 277
 - opening and closing 269
 - safety instructions 267
 - Engine coolant
 - check the level 272
 - exterior 20
 - specifications 270
 - temperature indicator 18
 - warning lamp 18
 - Engine failure
 - control lamp 249
 - Engine management 248
 - control lamp 249
 - Engine oil
 - change 275, 278
 - check the oil level 277
 - consumption 277
 - dipstick 277
 - inspection service 275
 - maintenance frequencies 275
 - refill 277
 - specifications 275
 - Engine oil pressure
 - control lamp 278
 - Engine specifications 323
 - Environment
 - ecological driving 109
 - environmental compatibility 314
 - recycling of electrical appliances 315
 - refuelling 246
 - Environmental tip
 - refuelling 246
 - ESC
 - connecting and disconnecting 133
 - electronic stability control (ESC) 132
 - Sport mode 133
 - Ethanol (fuel) 248
 - Event Data Recorder 312
 - Exhaust gases 248
 - Exiting a parking space
 - with the parking assist system 173
 - Exterior lighting
 - change a bulb 262
 - Exterior mirrors
 - driving with a trailer 234
 - fold manually 100
 - folding 100
 - heated 100
 - settings 100
 - External antenna 311
 - External audio sources
 - adapting the playback volume 202
- ## F
- Fabrics: clean 307
 - Factors that have a negative influence on safe driving 37
 - Fastening rings 230
 - Filling capacities
 - window washer water 274
 - Filling the tank 246
 - Fire 62
 - Frequency bands 208
 - Front bonnet 267
 - Front camera 137

- Front compartment
 brake fluid 273
 coolant 270, 272
 windscreen washer reservoir 274
- Front passenger airbag
 control lamp 48
- Fuel
 ethanol 248
 fuel gauge 17
 identification 247
 petrol 247
 refuelling 246
 saving 109
- Fuel consumption
 inertia disconnection 109
 why does consumption increase? 249
- Fuel gauge
 control lamp 17
- Fuel tank cap
 opening and closing 246
- Fuel tank flap
 opening and closing 246
- Full Link 191
 applications 192
 settings 192
 symbols 192
- Full-LED headlights 262
- Fuses 259
 colour coded 260
 fuse box 259, 260
 preparations for replacing fuses 260
 recognise blown fuses 260
 replace 260
- G**
 Gear change
 manual gearbox 120
 Gear indication 109
 Gear-change recommendation 109
 Glove compartment 178
- H**
 Hangers 180
 Hazard warning lights 61
 Head-on collisions and the laws of physics 42
 Headlight range control 93
 Headlights
 trips abroad 93
 Headrest 85
 adjust 85
 removing 86
 Heating 102
 Heating and fresh air 105
 Hill start assist 127
- I**
 i-Size 56
 Identification of fuels 247
 Ignition 113
 Ignition key extraction lock 113
 Ignition lock 113
 Indicator lamps
 overview 11
 Inertia mode 125
 Information call 63
 Infotainment 195
 adapt menus 201
 Android Auto™ 193
 Apple CarPlay 192
 assistants and vehicle settings 35
 before first use 195
 clean 203
 connecting and disconnecting 201
 customise 201
 customised menus 201
 drop-down menu 201
 executing functions 201
 function buttons 33
 help 32
 initial configuration 34
 Internet access 190
 Media mode 211
 navigation 214
 operating 201
 overview and controls 198, 199
 Radio mode 207
 safety instructions 195
 share a WLAN connection 190
 sound settings 202
 system settings 202
 technical data 203
 telephone interface 221
 tutorial 32
 vehicle information 36
 WLAN 190
- Infotainment system
 see Infotainment 32
- Inspection 275, 302
 Inspection reminder 23
 Inspection service 275
- Installing software
 over-the-air updates 183

Instrument cluster	13	troubleshooting	69	daytime running lights	89
Basic digital	14	unlocking and locking the vehicle	68	dipped beam headlights	88
date and time	23	Keys		fog light	90
service intervals display	23	changing the battery	67	headlight range control	93
Instrument cluster display	14	remote control	66	instrument lighting	94
instrument cluster lighting	94	spare key	66	interior lights	94
Instrument panel		synchronise	68	leaving home	92
digital (SEAT Digital Cockpit)	16	unlock and lock	71, 76	main beam assist	91
status display	19	vehicle key	66	main beam headlight lever	90
symbols	11			main beam headlights	88
use with the multifunction steering wheel	31	L		reading lights	94
warning and control lamps	11	Lane Assist	151	side lights	88
warning and information messages	22	control and warning lamp	152	switching on and off	88
Instrument panel display	16, 19	control lamps	153	turn signal lever	90
Interior mirror		Lane Assist system	151		
anti-dazzle	99	Lane departure warning (Side Assist)		Loading the luggage compartment	
Interior monitoring and the anti-tow system		control lamp	157	fastening rings	230
activation	75	driving situations	158	Loading the vehicle	
ISOFIX	56	how it works	156	general advice	227
ISOFIX system	56	indication on the exterior mirror	157	luggage compartment	227
		lane change Plus	157	positioning the load	227
		system limitations	156	positioning the luggage	227
J		Leaving Home	92	roof carrier system	232
Jack	251	Legal provisions	187	trailer	237
position points	295	Licenses	203	Lock and unlock	68
Jump leads	253	Lift the vehicle	295	in the locking cylinder	76
Jump start	253	Light Assist	91	with the central locking button	72
description	253	Lights		Luggage compartment	79, 227
jump leads	253	audible warnings	89	emergency unlocking	79
		AUTO	88	enlarge	84
K		change a bulb	262	luggage compartment lighting	94
Key switch	50	coming home	92	removing and fitting the shelf	228
Keyless Access		control and warning lamps	88	store the rear shelf	228
Press & Drive	114	control lighting	94	variable luggage compartment floor	229
starting the engine	116	controlling the lights	88	Luggage compartment floor	229
		cornering light	89	Lumbar support	84

M

- Main beam assist 91
 - Main beam headlight lever 90
 - Maintenance frequencies 275
 - Malfunction
 - adaptive cruise control 148
 - clutch 126
 - towing device 235
 - Manual gearbox 120
 - Mats 109
 - Media Mode 211
 - equipment 212
 - symbols 212
 - Microfiber: clean 307
 - MirrorLink®
 - settings 192
 - Mirrors 98
 - adjusting the exterior mirrors 100
 - anti-dazzle 99
 - Mobile phones 311
 - Mobility Service 304
 - Multimedia 194, 207
 - favourites 212
 - play 212
 - select source 212
- N**
- Navigation 214, 217
 - decrease the navigation map 215
 - edit route 219
 - enter an address for a guide destination 217
 - favourite destinations 218
 - frequent destinations 217
 - function: entering destination 217
 - functions 215
 - increase the navigation map 215
 - last destinations 217
 - learn usage pattern 219
 - limitations 214
 - navigation announcements 214
 - operating the navigation map 215
 - route details 219
 - save destination 218
 - saved data 215
 - saved destinations 218
 - symbols 215
 - traffic reports 218
 - updating navigation data 217
 - use contact details 218
 - Noise
 - brakes 130
 - tyres 285
 - Number of seats 39
- O**
- Octane (petrol) 247
 - Odometer 14, 16
 - partial 20
 - total 20
 - Oil change 278
 - On-board toolkit 251
 - One-touch signalling function 90
 - Online services 184
 - Opening 70
 - bonnet 269
 - tank cap 246
 - windows 79
 - Opening and closing 70
 - bonnet 269
 - by remote control 71
 - doors 75
 - in the locking cylinder 76
 - rear lid 79
 - tank cap 246
 - windows 79
 - with the central locking button 72
 - Operation in winter
 - salt on the roads 98
 - snow chains 290
 - tyres 290
 - Original accessories 304
 - Over-the-air updates 182
 - download 183
 - installing software 183
 - requirements 183
 - Overview
 - of warning and control lamps 11
 - overview (left hand drive) 9
 - overview (right hand drive) 10
 - view of the vehicle from inside 8
 - view of the vehicle from the front 6
 - view of the vehicle from the rear 7
 - Ownership accreditation 186
- P**
- Painting the vehicle
 - care 306
 - Park assist
 - fault 162
 - operating 164
 - parking aid plus 162
 - rear parking aid 166
 - see the Park assist system 167
 - sensors and camera: clean 306
 - surroundings warning 162
 - visual indication 165
 - Park assist system 167

- Parking 159
 automatic gearbox 124
 with the parking assist system 172
- Parking assist system 172
 angle parking 172
 description 168
 leaving a parking space (only when parallel parked) 173
 parallel parking 172
 parking conditions 172
 stop early 169
- Parking brake 160
- Parking systems 160
 automatic brake operation 160
 reverse assist (Rear View Camera) 174
 troubleshooting 161
- Partial odometer 23
- Particulate filter 249
- Pedals 39, 109
- Petrol 247
 additives 247
 particulate filter 249
 refuelling 247
- Places with risk of explosion 222
- Places with special regulations 222
- Power sockets 180
 trailer 235
- Preheat the engine 116
- Preheating 113
- Press & Drive 114
 start button 114
 starting the engine 116
- Privacy 189
 settings 189
- Private emergency call service 63
- R**
- Radar sensors 136
- Radio 207
 equipment 208
 frequency bands 208
 preset buttons 208
 symbols 208
 Traffic information (TP) 209
 tune station 208
 type of reception 208
- Radio mode 207
- Radio screen: clean 307
- Radio telephones 311
- Rain and light sensor 97
- Rain sensor 98
 function control 98
- Raise the vehicle 295
- Rear camera 139
- Rear Cross Traffic Alert 176
- Rear Cross Traffic Alert (RCTA) 176
- Rear fog light 88
 control lamp 88
- Rear lid 78, 79
- Rear mounting 241
 towing device 241
- Rear park assist 167
 visual indication 167
- Rear parking aid 166
- Rear radar 137
- Rear View Camera 174
- Rear window wiper 96
- Refuelling 17
 control lamp 17
 fuel gauge 17
 opening the fuel tank flap 246
 safety warnings 246
- Releasing the seat belt 43
- Remote control key 71
 unlock and lock 71
- Repair work 310
- Requirements for Apple CarPlay 192
- Rev counter 14
- Reverse assist 174
- Reverse assist (Rear View) 174
 parking 175
 shown on the display 175
- Reverse assist system 174
- Revolution counter 16, 17
- Road signs 27
 shown on the display 27
- Road signs detection system 27
 how it works 27
 limited operation 28
 settings 28
 shown on the display 27
 troubleshooting 30
 warning levels 29
 windscreen damage 28
- Roof carrier 230
 fix the crossbars 231
- Roof carrier system 230
- Roof rack 230
- Rotation direction 296
 tyres 296
- Running in 130
 new brake pads 130
 new engine 112
 new tyres 285
- S**
- Safe 73, 117
- Safe driving 37

Safe security system	73	faults	188	Shift paddles (automatic transmission)	123
troubleshooting	73	legal provisions	187	Snow chains	290
Safety		SEAT Digital Cockpit	16	Sound settings	202
child safety	52	SEAT Drive Profile	129	Spare parts	310
child seats	52	SEAT Drive Profiles	129	Spare wheel	292
safe driving	37	selecting a profile	129	Special characteristics	
Safety equipment	37	Seat heating	106	Android Auto™	194
Safety instructions	195	SEAT ID	186	Apple CarPlay	193
head-protection airbags	52	Seats		tow start	255
seat belt tensioners	46	adjusting the headrests	85	towing	255
side airbags	50	backrest of the rear seat	84	trailer mode	238
using child seats	54	fitting the headrest	86	Speed limiter	141
using seat belts	41	heating	106	control lamps	142
Save fuel		incorrect positions	39	indication on display	141
inertia mode	125	manual adjustment	84	operating	141
Screen		number of seats	39	Speed symbol	285
clean	203	removing the headrest	86	Stabilisation of the towing vehicle and trailer combination	239
Seat belt tensioners	45	Selection of driving profile		Start button	114
control lamp	48	characteristics	129	Start the engine by towing	256
Seat belts		Selector lever (automatic transmission) positions	121	special characteristics	255
adjusting the seat belt	44	Selling the vehicle	187	Start-Stop	118
adjustment	43	Service		Start-Stop system	
automatic retractor, tensioner and belt force limiter	45	Digital Maintenance plan	302	disconnect and connect manually	120
control lamp	41	inspection	302	driver indications	120
maintenance and disposal of seat belt tensioners	46	proof of Service	302	how it works	118
protective function	40	service packages	304	lamps	118
purpose	46	service works	302	stopping and starting the engine	118
safety instructions	41	terms of use	303	the engine does not turn off	118
symbols	42	Service interval indicator	23	the engine starts by itself	118
unfastened	42	Service intervals	23	Starting up the engine	113
SEAT CONNECT	184	Service Menu		Status display	
activation	186	service interval indicator	23	adaptive cruise control	144
deactivate	188	vehicle identification number	23	date and time	23
		Service Mobility	304	doors, front bonnet and rear lid open	19
		Set of vehicle keys	66	Eco-driving notes	142

- Emergency brake assistance system (Front Assist) 149
- instrument panel 19
- odometer 20
- outside temperature 20
- road signs 27
- SEAT Drive Profile 129
- selector lever positions 121
- service intervals 23
- speed limiter 141
- speed warning 20
- Travel Assist 154
- tyre pressure monitoring 297
- warning and information messages 22
- Steering
- control lamp 128
- electromechanical steering 128
- steering assist 128
- Steering assist 128
- Steering wheel
- adjust 83
- controls 82
- shift paddles (automatic transmission) 123
- Storage compartment 178
- drawers 179
- glove compartment 178
- on-board documentation 178
- other object holders 180
- Storage compartment accessories
- see Storage 178
- Storage of accident data 312
- Storing objects 227
- fastening rings 230
- loading the trailer 237
- positioning the load 227
- positioning the luggage 227
- roof carrier 230
- roof carrier system 230, 232
- trailer 232
- trailer mode 238
- Sun blind 101
- Sun protection 101
- Switching off
- telephone 222
- Symbols
- see Warning and control lamps 11
- System settings 202
- T**
- Tail lights on the bodywork
- remove the tail light 264
- Technical data
- engine specifications 323
- vehicle dimensions 324
- vertical load on the tow hitch 232
- weights 321
- Technical modifications 310
- Telephone
- connecting 223
- contacts 225
- favourites 225
- pairing a mobile phone 223
- phone book 225
- send messages 224
- speed dial buttons 225
- switching off 222
- to call 224
- Telephone interface 221
- equipment 221
- places with risk of explosion 222
- symbols 221
- Time
- adjust 23
- Tiptronic (automatic transmission) 123
- Top Tether 59
- Top Tether System 59
- Torque
- wheel nuts 296
- Touch screen 198, 199
- Tow cable 234, 235
- Towable loads
- loading the trailer 237
- Towing device
- fitting a bicycle carrier 240
- fitting later 241
- malfunction 235
- Towing the vehicle
- emergency towing 257
- front towline anchorage 257
- prior steps 257
- rear towline anchorage 258
- special characteristics 255
- tow bar 255
- tow cable 255
- towing prohibited 256
- Traction control 132
- Traffic information 218
- Traffic information (TP) 209
- Traffic programme
- see TP (traffic information) 209
- Trailer
- adjusting the headlights 238
- anti-theft alarm 235
- connecting 235
- exterior mirrors 234
- hitching 235
- LED tail lights 234, 235

- loading 237
 - malfunction 235
 - power socket 235
 - retrofitting a towing bracket 241
 - stabilisation of the towing vehicle and trailer combination 239
 - tail lights 234, 235
 - technical requirements 234
 - tow cable 234, 235
 - towable loads 237
 - trailer mode 238
 - vertical load on the tow hitch 232, 237
 - Trailer mode
 - see Trailer 232
 - Transportation of children 52
 - Travel Assist 153
 - connecting and disconnecting 155
 - problems and solutions 155
 - see Travel Assist 153
 - status display 154
 - Trips abroad 113
 - headlights 93
 - Troubleshooting
 - DSG gearbox 126
 - Start-Stop system 120
 - Travel Assist 155
 - Turn signal lever 90
 - Turning off the lights 88
 - Turning on the lights 88
 - Turning the ignition on and off 113
 - Tyre mobility system
 - check after 10 minutes 301
 - components 299
 - inflating the tyre 300
 - sealing the tyre 300
 - Tyre pressure 287
 - Tyre pressure monitor system 298
 - Tyre pressure monitor systems
 - tyre pressure monitor indicator 297
 - Tyre profile 289
 - Tyre repair 298
 - Tyre repair kit 298
 - Tyre tread depth 289
 - Tyre wear 289
 - Tyres 285
 - accessories 285
 - change 291
 - directional tread pattern 285, 296
 - for winter 290
 - foreign objects inserted 285
 - new tyres 286
 - snow chains 290
 - speed symbol 285
 - tread wear indicators 289
 - tyre pressure 287
 - useful life 287
- U**
- Ultrasound sensors 138
 - Unlock and lock 68
 - by remote control 71
 - doors 75
 - with the central locking button 72
 - USB 194
 - USB port 194
- V**
- Vanity mirror 101
 - Variable luggage compartment floor 229
- Vehicle**
- data label 321
 - engine specifications 323
 - identification data 321
 - interior view 8
 - lending or selling 187
 - overview (left hand drive) 9
 - overview (right hand drive) 10
 - raise 295
 - unlocking and locking (Keyless Access) 68
 - vehicle ID number 321
 - view from behind 7
 - view from the front 6
- Vehicle care**
- wiper blade service position 251
- Vehicle conservation** 305
- Vehicle conservation products** 305
- Vehicle dimensions** 324
- Vehicle information** 36
- Vehicle location** 187
- Vehicle seats** 39
- Vehicle settings** 35
- Vehicle tool kit** 251
- Ventilation** 102
- Vertical load on the tow hitch** 232
 - loading the trailer 237
- Voice control** 205
 - activation word: 206
 - Android Auto™ 194
 - end 206
 - Siri™ (Apple CarPlay™) 193
 - start 206
- Volume**
- set for external audio sources 202

W

- Warning lamps
 - overview 11
- Warning triangle 61
- Warranty 312
- Washing the vehicle
 - cleaning the exterior 306
 - high pressure cleaning equipment 305
 - interior cleaning 307
 - special care 308
- Weights 321
- Wheel balance 287
- Wheel central trim 293
- Wheel nuts 289
 - anti-theft device 294
 - caps 293
 - loosen 294
 - torque 296
- Wheel spanner 251
- Wheels
 - change 291
 - changing 289
 - new wheels 286
 - removing and attaching 296
 - snow chains 290
 - spare wheel 292
 - wheel central trim 293
 - wheel nuts 289
- Window controls 79
- Window washer system 274
- Window washer water
 - check 274
 - filling quantities 274
 - refill 274
- Windows 79
 - anti-trap function 81
 - automatic opening/closing 80
 - automatic operation 80
- Windscreen washer 96
- Windscreen wipers
 - functions 97
 - lift the blade 251
 - rain and light sensor 97
 - reposition the blade 251
 - service position 251
 - special characteristics 96
 - wiper lever 96
- Winter conditions
 - trailer 232
- Winter tyres 290
- Wiper and rear window wiper blades
 - cleaning the vehicle 252, 306
 - replacement 252
 - service position 251
- WLAN 190


SEAT S.A. is permanently concerned about continuous development of its types and models. For this reason we ask you to understand, that at any given time, changes regarding shape, equipment and technique may take place on the car delivered. For this reason no right at all may derive based on the data, drawings and descriptions in this current handbook.

All texts, illustrations and standards in this handbook are based on the status of information at the time of printing. Except for error or omission, the information included in the current handbook is valid as of the date of closing print.

Re-printing, copying or translating, whether total or partial is not allowed unless SEAT allows it in written form.

SEAT reserves all rights in accordance with the "Copyright" Act.

All rights on changes are reserved.

 This paper has been manufactured using bleached non-chlorine cellulose.

© SEAT S.A. - Reprint: 15.11.24



ARONA
Inglés
Edición: (11.24)
6F9012720CC

