



5D / Sportstourer

Leon

Owner's manual

Vehicle identification data

Model:
Vehicle Registration:
Vehicle identification number:
Date of vehicle registration or vehicle delivery:
SEAT Official Service:
Service advisor:
Telephone:

Confirmation of receipt of documentation and vehicle keys

The following items were delivered with the vehicle:	YES	NO
On-board documentation	<input type="checkbox"/>	<input type="checkbox"/>
First key	<input type="checkbox"/>	<input type="checkbox"/>
Second key	<input type="checkbox"/>	<input type="checkbox"/>
Correct working order of all keys was checked	<input type="checkbox"/>	<input type="checkbox"/>
Location:		
Date:		
Signature of owner:		

Thank you for your confidence

With your new SEAT, you will be able to enjoy a vehicle with state-of-the-art technology and top quality features.

We recommend reading this Instruction Manual carefully to learn more about your vehicle so you can enjoy all its benefits in your daily driving.

Information about handling is complemented with instructions regarding the operation and maintenance of the vehicle in order to ensure its safety and maintain its value. Moreover, we want to give you valuable advice and tips to drive your vehicle efficiently and respecting the environment.

We wish you safe and enjoyable motoring.

SEAT, S.A.

WARNING

Read and always observe safety information concerning the passenger's front air-bag >>> page 61, *Fitting and using child seats.*

Table of Contents

About this instruction manual	4	Opening and closing	87	Start-Stop system	159
General views of the vehicle	6	Set of vehicle keys	87	Manual gearbox	162
Front exterior view	6	Keyless Access system	90	DSG automatic transmission	163
Front exterior view	7	Central locking	92	Driving on slopes	168
Rear exterior view	8	Anti-theft alarm	96	Steering	169
Rear exterior view	9	Doors	97	SEAT Drive Profiles	170
Interior view	10	Rear lid	99	Braking system	172
Overview (left hand drive)	11	Window controls	104	Brake assist systems	173
Overview (right hand drive)	12	Sunroof	106	Assistant systems	177
Driver information	13	Steering wheel	109	General notes	177
Control lamps	13	Multifunction steering wheel	109	Drive assist sensors and cameras	178
Instrument panel	15	Seats and head restraints	111	Cruise control system	181
Instrument cluster operation	32	Front seats	111	Speed limiter	183
Infotainment system operation and displays	33	Rear seats	112	Eco-efficient driving assistance	184
Safety	41	Headrest	113	ACC - Adaptive Cruise Control	185
Safe driving	41	Seat functions	116	Predictive speed adjustment	191
Correct sitting position of vehicle occupants	42	Lights	118	emergency brake assistance system (Front Assist)	193
Seat belts	44	Vehicle lighting	118	Lane Assist system	197
PreCrash system	50	Interior lights	123	Driving Assist (Travel Assist)	199
Airbag system	51	Visibility	126	Emergency Assist	203
Transporting children safely	59	Windscreen wiper and rear window wiper systems	126	Lane departure warning (Side Assist)	205
In case of emergency	69	Mirrors	131	Parking and manoeuvring	208
High-voltage battery	73	Sun protection	131	Park the vehicle	208
Safety instructions	73	Air conditioning	132	Electronic parking brake	209
Conservation of the high-voltage battery	75	Heating, ventilation and cooling	132	General information on parking systems	211
Charging the high-voltage battery	76	Auxiliary heating (additional heating)	140	Park Distance Control Plus (Park Pilot)	213
Charging settings in the infotainment system	81	Stationary air conditioning	144	Rear parking aid	216
Charging cable	82	Driving	147	Parking aid system (Park Assist)	217
		Driving indications	147	Reverse Assist (Rear View Camera)	224
		Starting and stopping the engine	152	Rear Cross Traffic Alert	227
		Driving with electric drive	156	Exit Warning	228
		Operating mode selection	158	Practical equipment	230
				Storage compartment	230
				Power sockets	232

Data transmissions	235	Fuses	321	Technical data	381
Over-the-air update	235	Changing bulbs	324	Indications about the technical data	381
SEAT CONNECT	237	Checking and refilling levels	325	Index	389
Privacy mode	241	Engine compartment	325		
WLAN access point	242	Fluids and consumables	328		
Full Link	244	Cooling system	328		
Wired and wireless connections	248	Brake fluid	332		
Infotainment system	250	Windscreen washer reservoir	333		
First steps	250	Engine oil	334		
Overview and controls	253	12-volt battery	337		
General instructions for use	255	48-volt battery	342		
Voice control	260	Energy management	343		
Radio mode	262	Wheels and tyres	345		
Media Mode	266	Important information about wheels and			
Navigation	269	tyres	345		
Telephone interface	276	Changing a wheel	351		
Storing objects	282	Tyre pressure monitor system	357		
Positioning the luggage and cargo	282	Tyre repair	359		
Luggage compartment	283	Maintenance	362		
Net partition	287	Service	362		
Luggage compartment equipment	289	Additional service offers	364		
Roof carrier	292	Vehicle upkeep and cleaning	365		
Trailer mode	294	Accessories, spare parts and repair work	370		
Fuel and exhaust gas cleaning	305	Information for the user	372		
Refuelling	305	Warranty	372		
Fuel types	307	Information stored by the control units	372		
AdBlue®	308	Vehicle antennas	373		
Engine management and emissions control		Information on the EU chemicals regulation			
system	310	REACH	373		
Miscellaneous situations	313	Materials and recycling information	373		
Vehicle tool kit	313	Return and scrapping of end-of-life vehicles	375		
Changing the windscreen wiper blades	313	Declaration of conformity	375		
Jump start	315	Radioelectrical equipment	376		
Towing the vehicle	317				

About this instruction manual

This instruction manual is valid for all variants and versions of your SEAT model. It describes all equipment and models without specifying whether they are optional equipment or model variants. As a result, equipment not fitted to your vehicle or only available in certain countries may be described. Find out about your vehicle's equipment in the documentation supplied with it and please contact your SEAT Official SEAT Service if you require more detailed information.

All information provided in instruction manual corresponds to the information available at the time of going to press. As the vehicle is under continuous development, it may have differences to the data included in this manual. For this reason, no claims can be made in the event of mismatching data, illustrations and descriptions.

Ensure that the on-board documentation is kept in the vehicle at all times if you sell it or lend it to third parties. In addition, SEAT recommends resetting the infotainment system to factory settings to delete all personal data.

Some details on the **drawings** may be different to your vehicle and they should be interpreted as a standard representation.

The **direction indicators** (left, right, forwards, backwards) in this manual refer to the direction of travel of the vehicle unless otherwise stated.

This instruction manual has been written for **left-hand drive vehicles**. In right-hand drive vehicles, the arrangement of the controls differs partly from that shown in the illustrations or described in the texts.

Technical modifications to the vehicle or safety-critical issues that have arisen since the time of going to press will be included in a supplement to the on-board documentation.

® **Trademarks** are marked with ®. The absence of this symbol does not guarantee that the term is not a trademark.

You can access the information in this manual using:

- Thematic table of contents that follows the manual's general chapter structure.
- Visual table of contents that uses graphics to indicate the pages containing "essential" information, which is detailed in the corresponding chapters.
- Alphabetical index with many terms and synonyms to help you find information.

! NOTICE

Texts after this symbol indicate possible damage to the vehicle.

🌱 For the sake of the environment

Texts after this symbol contain information on environmental protection.

i Note

Texts after this symbol contain additional information.

⚠ WARNING

Texts after this symbol contain information about safety and warn you about possible accident or injury risks.

Digital instruction manual

The digital version of the manual can be found on SEAT's official website:



Fig.1 SEAT website

- scan the QR code.
- **OR** enter the following address in the navigator website:

<https://www.seat.com/owners/about-my-car/manuals.html>

and select your vehicle.

Related videos

The operation of some of the vehicle's features can be shown as an instruction video:



Fig.2 SEAT website

- scan the QR code.
- **OR** enter the following address in the navigator website:

<https://www.seat.com/owners/about-my-car/manuals.html>

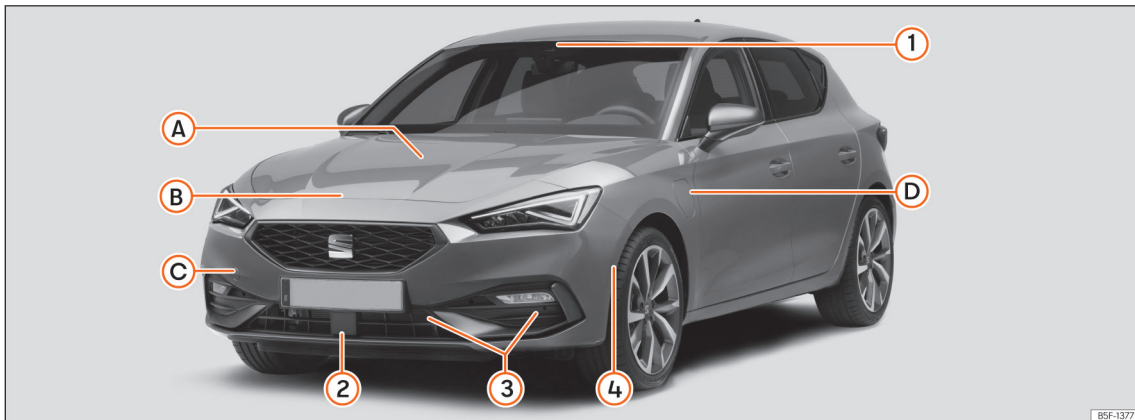
choose your vehicle and then the "Multimedia" section.

Note

Video instructions are only available in certain languages.

General views of the vehicle

Front exterior view



85F-1377

Driving assistance sensors >>> page 177

- ① Front multifunction camera
- ② Front radar
- ③ Park distance control sensors
- ④ Park assist sensor

⑤ Levels control

Oil >>> page 334

Brake fluid >>> page 332

Battery >>> page 337

⑥ Bonnet

Unlocking lever >>> page 327

Open/close >>> page 327

⑦ Towing the vehicle

Tow start >>> page 318

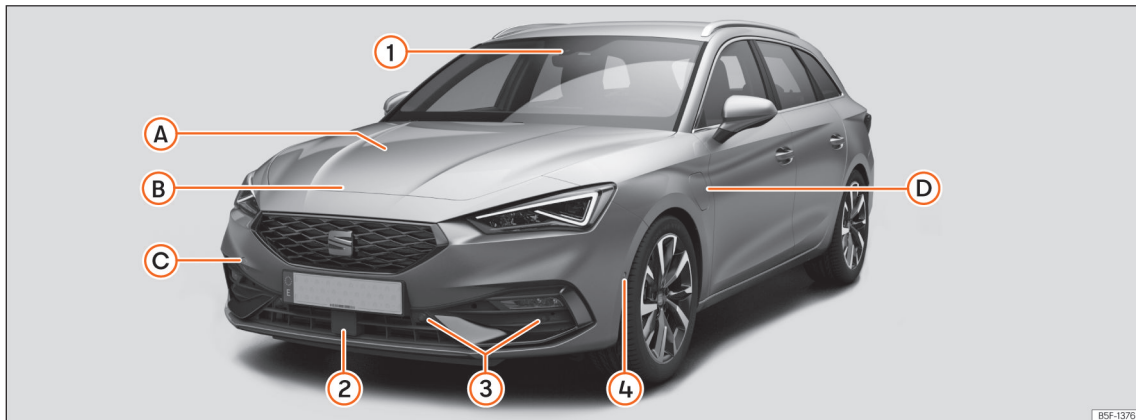
Towline anchorage >>> page 319

⑧ Charging socket (hybrid vehicles)

Charging process display >>> page 79

Emergency unlocking >>> page 80

Front exterior view



BSF-1376

Driving assistance sensors >>> page 177

- ① Front multifunction camera
- ② Front radar
- ③ Park distance control sensors
- ④ Park assist sensor

A Levels control

- Oil >>> page 334
- Brake fluid >>> page 332
- Battery >>> page 337

B Bonnet

- Unlocking lever >>> page 327
- Open/close >>> page 327

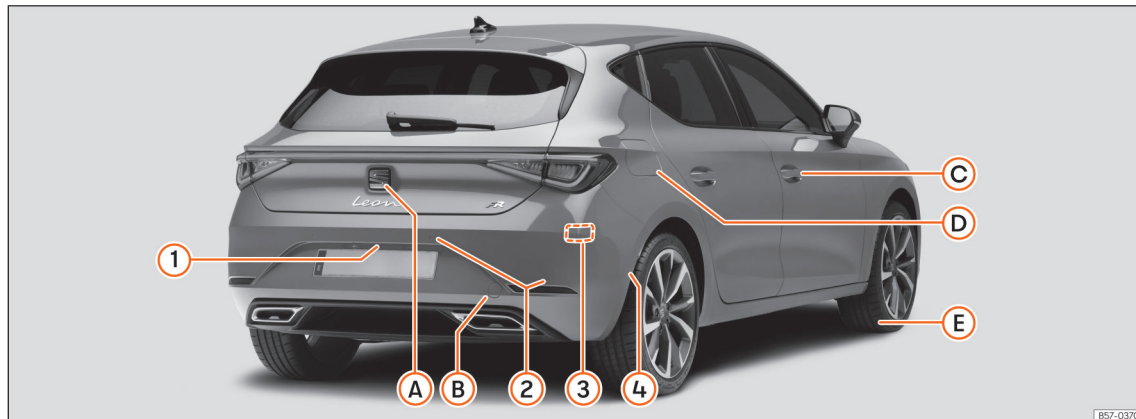
C Towing the vehicle

- Tow start >>> page 318
- Towline anchorage >>> page 319

D Charging socket (hybrid vehicles)

- Charging process display >>> page 79
- Emergency unlocking >>> page 80

Rear exterior view



Driving assistance sensors >>> page 177

- ① Rear view camera
- ② Park distance control sensors
- ③ Rear radars
- ④ Park assist sensor

A Rear lid

- Opening from outside >>> page 100
- Emergency opening >>> page 103

B Towing the vehicle

- Tow-start >>> page 318
- Towline anchorage >>> page 320

C Opening and closing

- Doors >>> page 97
- Central locking >>> page 92
- Emergency lock >>> page 98

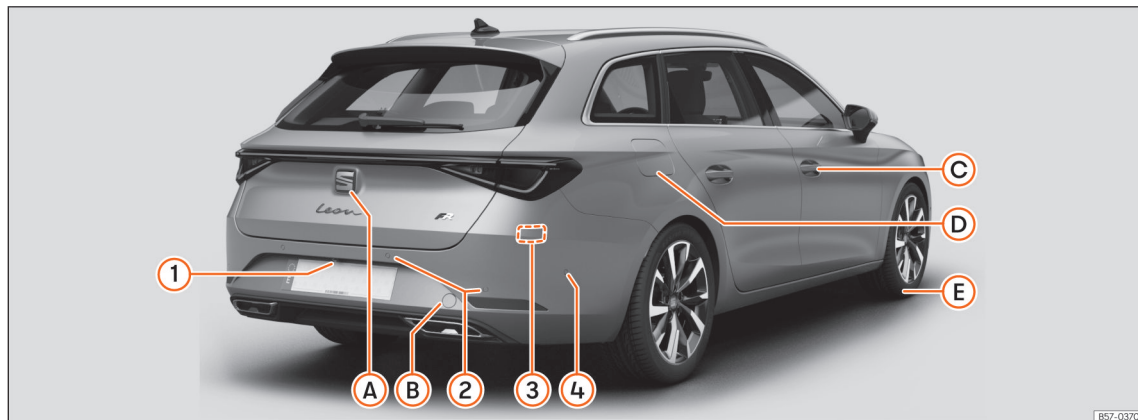
D Fuel tank

- Fuel capacity >>> page 381
- Open/Close cap >>> page 306

E Action in the event of a puncture

- Anti-puncture kit >>> page 359
- Wheel change >>> page 351

Rear exterior view



B57-0370

Driving assistance sensors >>> page 177

- ① Rear view camera
- ② Park distance control sensors
- ③ Rear radars
- ④ Park assist sensor

A Rear lid

- Opening from outside >>> page 100
- Emergency opening >>> page 103

B Towing the vehicle

- Tow-start >>> page 318
- Towline anchorage >>> page 320

C Opening and closing

- Doors >>> page 97
- Central locking >>> page 92
- Emergency lock >>> page 98

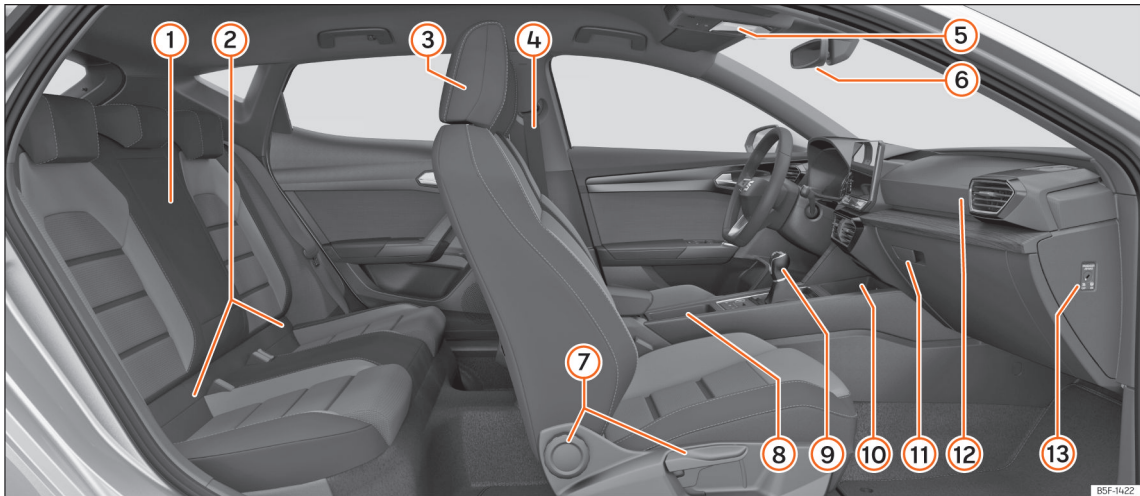
D Fuel tank

- Fuel capacity >>> page 381
- Open/Close cap >>> page 306

E Action in the event of a puncture

- Anti-puncture kit >>> page 359
- Wheel change >>> page 351

Interior view



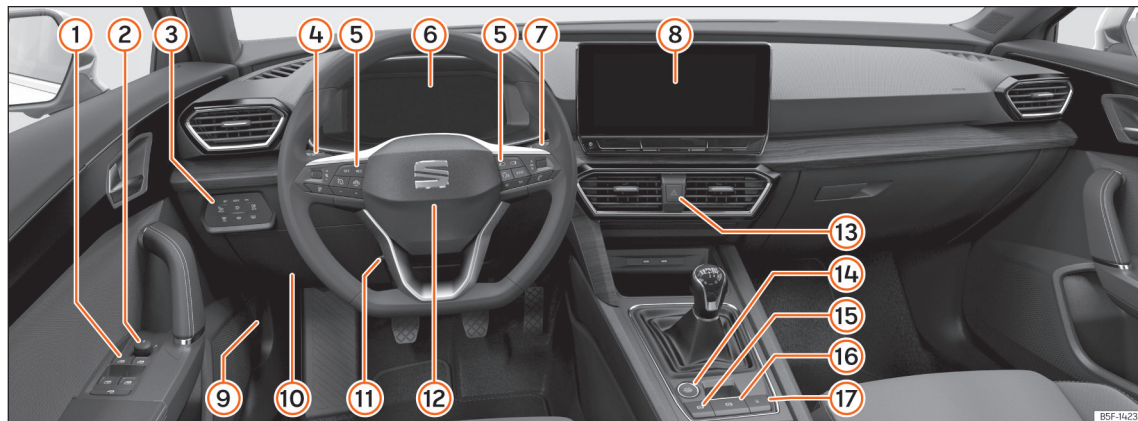
- ① Armrest »» page 291
- ② Isofix anchors »» page 62
- ③ Headrest adjustment »» page 113
- ④ Seat belts »» page 45
- ⑤ Sunroof »» page 106
- ⑥ Interior mirror »» page 129
- ⑦ Seat adjustment »» page 111

- ⑧ Emergency start »» page 156
- ⑨ DSG automatic transmission »» page 163 / Manual gearbox »» page 162
- ⑩ Connectivity Box / Wireless Charger »» page 280
- ⑪ Glove compartment »» page 230
- ⑫ Front passenger airbag »» page 54

- ⑬ Disconnecting the front passenger front airbag »» page 55

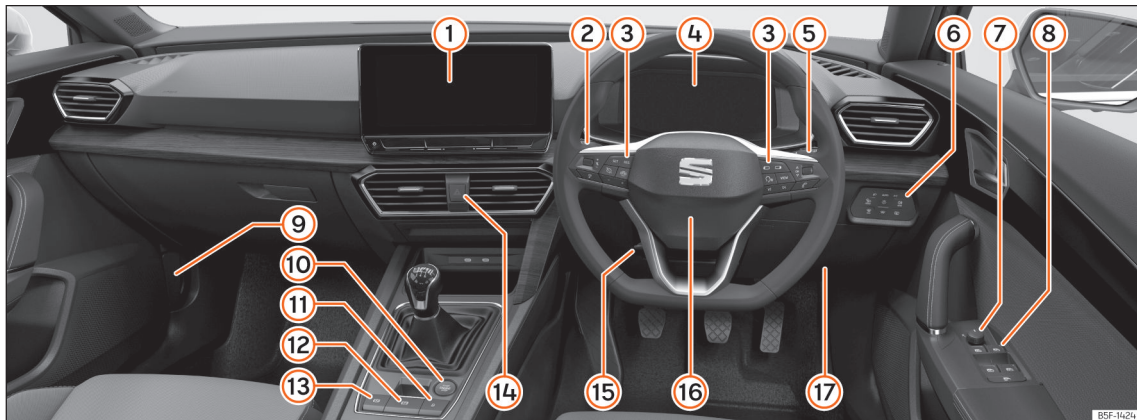
B5F-1422

Overview (left hand drive)



- | | | |
|---------------------------------------------------------------|-----------------------------------------------------------------------------------------------------|----------------------------------------|
| ① Electric windows »» page 104 | ⑦ Wipers and rear window wiper »» page 126 | ⑭ Start button »» page 152 |
| ② Exterior mirror adjustment »» page 130 | ⑧ Infotainment system »» page 33, »» page 250 | ⑮ Auto Hold »» page 210 |
| ③ Control for lighting and demisting windows »» page 118 | ⑨ Open bonnet lever »» page 327 | ⑯ Electronic parking brake »» page 209 |
| ④ Turn signal and main beam lever »» page 120 | ⑩ Fuses »» page 321 | ⑰ Central locking »» page 92 |
| ⑤ Multifunction steering wheel control panels »» page 109 | ⑪ Steering wheel adjustment »» page 110 | |
| ⑥ SEAT Digital Cockpit »» page 18
Control lamps »» page 13 | ⑫ Steering wheel with driver's airbag »» page 54 / Gear shift paddles for the Tiptronic »» page 165 | |
| | ⑬ Hazard warning lights »» page 69 | |

Overview (right hand drive)



- | | | |
|--------------------------------------------------------------------------------------------------------------------------------------------------------------------------------------------------------------------------------------------------------------------------------------------------------------------------------------------------------------------------|-------------------------------------------------------------------------------------------------------------------------------------------------------------------------------------------------------------------------------------------------------------------------------------------------------------------------------------------------------------------------------------------------------------------------------------------------------------------------------------|------------------------------------------------------------------------------------------------------------------------------------------------------------------------------------------------------------------------------|
| <p>① Infotainment system >>> page 33, >>> page 250</p> <p>② Turn signal and main beam lever >>> page 120</p> <p>③ Multifunction steering wheel control panels >>> page 109</p> <p>④ SEAT Digital Cockpit >>> page 18
Control lamps >>> page 13</p> <p>⑤ Wipers and rear window wiper >>> page 126</p> | <p>⑥ Control for lighting and demisting windows >>> page 118</p> <p>⑦ Exterior mirror adjustment >>> page 130</p> <p>⑧ Electric windows >>> page 104</p> <p>⑨ Hazard warning lights >>> page 69</p> <p>⑩ Open bonnet lever >>> page 327</p> <p>⑪ Start button >>> page 152</p> <p>⑫ Electronic parking brake >>> page 209</p> <p>⑬ Auto Hold >>> page 210</p> <p>⑭ Central locking >>> page 92</p> | <p>⑮ Steering wheel adjustment >>> page 110</p> <p>⑯ Steering wheel with driver's airbag >>> page 54 / Gear shift paddles for the Tiptronic >>> page 165</p> <p>⑰ Fuses >>> page 321</p> |
|--------------------------------------------------------------------------------------------------------------------------------------------------------------------------------------------------------------------------------------------------------------------------------------------------------------------------------------------------------------------------|-------------------------------------------------------------------------------------------------------------------------------------------------------------------------------------------------------------------------------------------------------------------------------------------------------------------------------------------------------------------------------------------------------------------------------------------------------------------------------------|------------------------------------------------------------------------------------------------------------------------------------------------------------------------------------------------------------------------------|

Driver information

Control lamps

Control and warning lamps

The warning and control lights can be lit individually or in combination and serve as a warning, to indicate the presence of an anomaly or to warn of the activation of certain functions. Some turn on when the ignition is switched on and have to be switched off after a certain period of time.

Depending on the model, additional text messages may be viewed on the instrument panel display. These may be purely informative or they may be advising of the need for action.










Depending upon the equipment fitted in the vehicle, instead of a warning lamp, sometimes a symbol may be displayed on the instrument panel.


















The control lamps that light up on the light control are explained in chapter **»» page 118, Lights**.

WARNING

If the warning lamps and messages are ignored, faults may occur in the vehicle, it may stall in traffic, or accidents and serious injuries may occur.

- Never ignore warning lamps or text messages.
- Stop the vehicle safely as soon as possible.

Symbol	Meaning
	 Stop driving! Central warning lamp »» page 26
	Fasten your seat belt »» page 45
	Electronic parking brake on »» page 209
	 Stop driving! Fault in the brake system »» page 173
	 Stop driving Brake fluid level low »» page 332
	Take control of the vehicle and be ready to brake! »» page 186

Symbol	Meaning
	 Stop driving! Fault in the motor coolant system »» page 22
	 Stop driving! Fault in the high-voltage system coolant fluid system »» page 22
	Engine oil pressure »» page 337
	 Stop driving! Steering anomaly »» page 169
	 Stop driving! Fault in the high voltage system »» page 80
	 Stop driving! Fault in the electric drive system »» page 158
	 Stop driving! 12 volt battery »» page 341
	 Stop driving! Alternator fault »» page 341
	 Stop driving! 48 volt battery »» page 343

Driver information

Symbol	Meaning
	Collision warning >>> page 194
	Take control of the steering immediately >>> page 203
	AdBlue level® too low, OR fault in the SCR system >>> page 310, >>> page 310
	Emergency Assist active with lane guidance >>> page 204
	Emergency Assist active without lane guidance >>> page 204
	Central warning lamp >>> page 26
	Fault in the airbag system or the seat belt tensioners >>> page 53
	Front passenger front airbag off >>> page 53
	Front passenger airbag on >>> page 53
	Electronic parking brake fault >>> page 210
	Please check brake pad >>> page 173
	Lights up: fault in the electronic stability control (ESC) >>> page 175
	Flashing: Electronic stability control (ESC) or Traction Control regulating >>> page 175

Symbol	Meaning
	TCS manually deactivated, ESC in Sport mode or ECS manually deactivated >>> page 175
	ABS fault >>> page 175
	Travel assist unavailable >>> page 203
	Fault in the vehicle's lighting >>> page 118
	Fault in the emissions control system >>> page 312
	Particulate filter clogged >>> page 312
	Diesel engine preheating; OR diesel engine management fault >>> page 312
	Petrol engine management fault >>> page 312
	Rear fog light on >>> page 118
	Fuel tank almost empty >>> page 21
	Engine oil level >>> page 337
	Presence of water in diesel. >>> page 21
	Steering anomaly >>> page 169

Symbol	Meaning
	Fault in the tyre pressure loss indicator >>> page 359
	! Stop driving! Low tyre pressure >>> page 358
	Fault in the electric drive system >>> page 158
	Electronic engine sound fault >>> page 158
	Front Assist not available >>> page 195
	Collision warning deactivated >>> page 196
	Cruise control fault (GRA) >>> page 183
	Speed limiter not available >>> page 184
	Gearbox fault >>> page 168, >>> page 168
	Adaptive cruise control (ACC) not available >>> page 190
	Emergency Assist unavailable >>> page 204
	Lane Assist not available >>> page 199
	Lane Assist (lane keeping system) regulating >>> page 198

Instrument panel

Symbol	Meaning
	Lane Assist deactivated >>> page 198
	Exit Warning not available >>> page 180
	Side Assist (lane change assistance system) not available >>> page 180
	Rear Cross Traffic Alert not available >>> page 180
	Battery / 12V power supply >>> page 341
	Battery / 48V power supply >>> page 343
	AdBlue level® low, OR fault in the SCR system >>> page 310, >>> page 310
	Auto Hold active >>> page 210
	Turn signals >>> page 118
	Trailer turn signals >>> page 118
	Cruise control (GRA) >>> page 181, >>> page 187
	Speed limiter active >>> page 183
	Lane Assist (lane keeping system) active. >>> page 198
	Press the brake pedal >>> page 168

Symbol	Meaning
	Travel Assist active >>> page 200
	Adaptive Cruise Control (ACC) regulating, no vehicle detected ahead >>> page 187
	Adaptive Cruise Control (ACC) regulating, vehicle detected ahead >>> page 187
	Vehicle charging >>> page 78
	Main beam on or flasher on >>> page 118
	The speed limiter is not active >>> page 183
	Start-Stop system activated >>> page 160
	Start-Stop system unavailable >>> page 160
	Travel Assist active, adaptive cruise control (ACC) active and adaptive lane guidance function passive. >>> page 200
	Lane assist active, manoeuvre available (highlighted arrow direction) >>> page 202
	Lane assist active, manoeuvre not available. >>> page 202

Symbol	Meaning
	Exterior temperature below +4 °C (+39 °F) >>> page 24
	Main beam assist active >>> page 121
	Take control of the steering >>> page 203
	Front assist switching on >>> page 195
	Distance warning >>> page 193
	Electric mode driving not available >>> page 159
	Reference to information in the on-board documentation >>> page 27
	Remove foot from accelerator >>> page 185
	Service intervals display >>> page 32

Instrument panel

Introduction

The vehicle can be fitted with a instrument panel digital lap timer or one Digital (SEAT Cockpit).

After switching the engine on with a 12-volt battery that is heavily discharged or newly changed some system settings (such as the

time, the date, the personalised comfort settings and the programming) might be altered or deleted. Check and correct these settings once the battery is sufficiently charged.

WARNING

Any distraction may lead to an accident, with the risk of injury.

- Do not operate the instrument panel controls when driving.
- To reduce the risk of accident and injury, only make adjustments to the instructions on the instrument panel display and to the instructions on the Infotainment system display when the vehicle is stationary.

Analogue instrument panel

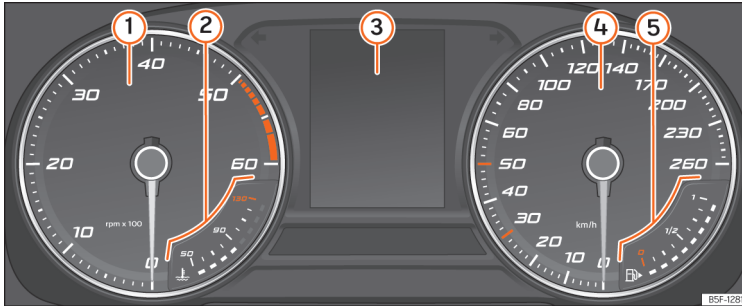


Fig. 3 Front passenger airbag located in instrument panel.

Explanations about the instruments >>> **Fig. 3:**

- ① **Revolution counter** (with the engine running, in hundreds of revolutions per minute)
>>> page 20.
- ② **Engine coolant temperature indicator**
>>> page 22.
- ③ **Indications on the display** >>> page 23.
- ⑤ **Speedometer.**
- ⑥ **Fuel gauge** >>> page 21.

SEAT Digital Cockpit

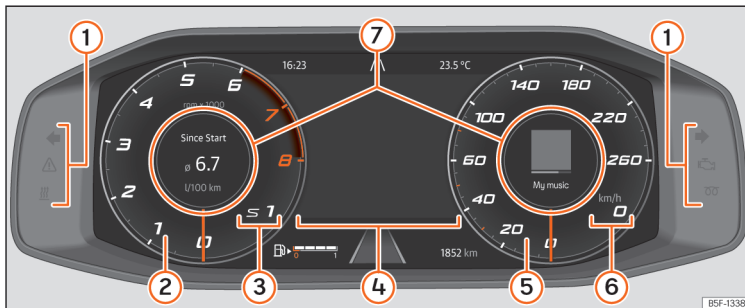


Fig. 4 SEAT Digital Cockpit on the instrument panel (classic view).

- ① Control and warning lamps »» page 13.
- ② Revolution counter. Revolutions per minute the engine is running»» page 20.
- ③ Gear engaged or selector lever position.
- ④ Screen display »» page 23.
- ⑤ Speedometer
- ⑥ Digital speed display
- ⑦ Information Profile »» page 19.

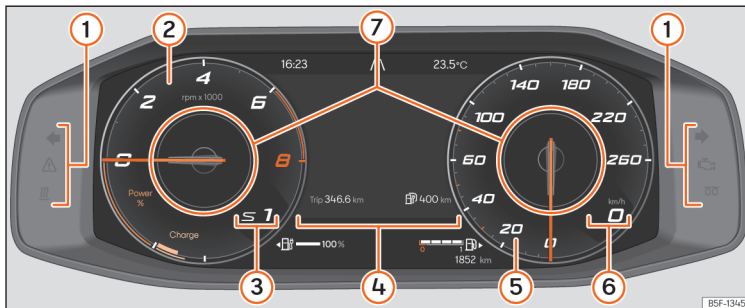


Fig. 5 Hybrid vehicles: SEAT Digital Cockpit on the instrument panel (classic view).

- ① **Control and warning lamps** »» page 13.
- ② **Rev counter and Powermeter.** Revolutions per minute the engine is running »» page 23.
- ③ **Gear engaged or selector lever position.**
- ④ **Screen displays** »» page 23.
- ⑤ **Speedometer**
- ⑥ **Digital speed display**
- ⑦ **Information Profile** »» page 19.

The Digital SEAT Cockpit is a digital instrument cluster with a high resolution colour TFT display. It has 5 views accessible using the button **VIEW** of the multifunction steering wheel.



By selecting different information profiles, indications other than the classic circular instruments can be displayed, such as navigation data, multimedia information or travel data.

The 5 views are:

- Classic
- Dynamic
- Assistance systems
- Navigation
- Night

All views will display information on the screen about audio, phone, travel data, vehicle status, navigation¹⁾ and driving aids¹⁾.

Information profiles

The  /  buttons on the multifunction steering wheel can be used to browse through the different SEAT Digital Cockpit information.

Information on the vehicle status, travel data and assistants will be displayed on the left side.


On the right side information will be displayed on: audio, telephone, compass, navigation manoeuvres and the G-force meter.

Depending on the view, the **central area** of the SEAT Digital Cockpit displays information about the following:




- *Classic View and Dynamic View:* Initial data, date, distance travelled and autonomy. Turning the right thumbwheel on the multifunction

¹⁾ Depending on the version.

steering wheel: navigation map, road signs, driving data (clicking on **OK** switches between the different memories).

- **Assistants View:** This is accessed by pressing the button  or the button **VIEW** on the multifunction steering wheel. Turning the right thumbwheel on the multifunction steering wheel displays the list of assistants. Press **OK** to turn the desired assistant on/off.
- **Navigation View:** By pressing the button **OK** on the multifunction steering wheel and then turning the thumbwheel you can view the map in a larger or smaller view. If you press the button **OK** again, the map returns to automatic scale.
- **Night View:** The speed is displayed in digital format.

Classic View

The revolutions per minute and speedometer needles appear in full length by a long press on the button **VIEW** on the multifunction steering wheel, regardless of the menu displayed in the central area ,  **Fig. 4**,  **Fig. 5**.

With another long press on the button **VIEW**, the display returns to the previous view.

Or looking in the instrument panel menu for the **X Close** option using the right hand thumbwheel on the multifunction steering wheel, and then press **OK**.

Information that may be displayed in the central area of the SEAT Digital Cockpit speedometer

- Audio
- Telephone
- Compass
- Navigation indications (the most recent destinations are displayed by pressing the arrow on the right of the multifunction steering wheel)
- **X > OK** (close classic view).

Information that may be displayed in the central area of the SEAT Digital Cockpit rev counter




- Consumption and average consumption. By pressing the arrow on the left of the multifunction steering wheel, you can switch between the different memories of the travel data.
- Autonomy (fuel tank level).
- Lubricating oil and coolant temperature
- Average speed. By pressing the arrow on the left of the multifunction steering wheel, you can switch between the different memories of the travel data.
- Other travel data: km travelled and driving time. By pressing the arrow on the left of the multifunction steering wheel, you can switch between the different memories of the travel data.


- Assist systems.
- **X > OK** (close classic view).

Revolution counter

The rev counter indicates the number of engine revolutions per minute.

Together with the gear-change indicator, the rev counter offers you the possibility of using the engine of your vehicle at a suitable speed.

The beginning of the red zone of the rev counter indicates the maximum speed in any gear after running-in and with the engine hot. However, it is advisable to move the selector lever to **D** or lift your foot off the accelerator before the needle reaches the red zone   .

We recommend that you avoid high revs and that you follow the recommendations on the gear-change indicator. See the additional information in  **page 147, *Selecting the optimal gear.***

NOTICE

- **To prevent damage to the engine, the rev counter needle should only remain in the red zone for a short period of time.**
- **When the engine is cold, avoid high revs and heavy acceleration and do not make the engine work hard.**

For the sake of the environment

Changing up a gear early will help you to save fuel and minimise emissions and engine noise.

Fuel gauge






Fig. 6 Analogue instrument cluster: fuel gauge



Fig. 7 Fuel gauge located in different positions depending on the view.

Indicator lamps

 Its lights up yellow. Fuel tank almost empty. The fuel reserve level has been reached >>> . Refuel as soon as you have the opportunity.

 Its lights up yellow. Presence of water in diesel. Turn off the engine and seek professional assistance.

The display only works when the ignition is switched on.

The fuel range is displayed on the instrument panel.

You can consult the tank capacity of your vehicle in >>> page 381.

WARNING

When driving with low fuel, the vehicle may stall in traffic and cause accidents and severe injuries.

- If the fuel tank level is too low, fuel could reach the engine irregularly, particularly when driving up or down slopes.
- The steering system and the assistant systems and brakes do not work when the engine is running irregularly or switches off due to lack of fuel or an irregular supply thereof.
- SEAT recommends always refuelling when the tank is approximately one quarter full, to prevent the vehicle from stopping due to a lack of fuel.

NOTICE

Never run the fuel tank completely dry. An irregular fuel supply can cause misfiring and unburnt fuel could enter the exhaust system. The catalytic converter or the particulate filter may get damaged!

Note

The small arrow on the fuel gauge next to the fuel pump symbol points out towards the side of the vehicle with the fuel tank flap.

Battery level indicator

✓ Valid for: hybrid vehicles



Fig. 8 Digital instrument cluster: battery level indicator.

The small arrow next to the battery symbol on the fuel gauge indicates which side of the vehicle the charging cover is on.

NOTICE

- Never drive with the tank completely empty. Under certain circumstances, the energy stored in the high-voltage battery may not be sufficient to reach the nearest service station.
- When the outside temperature is very low, and therefore the high-voltage battery is very cold, difficulties may arise in starting the internal combustion engine and the range in the electric driving mode may be reduced.

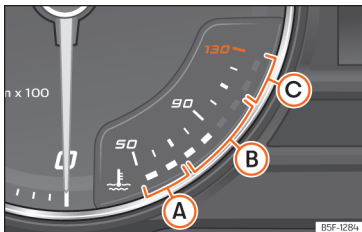

Coolant temperature indicator.

Fig. 9 Analogue instrument panel: engine coolant temperature display.

- A Cold zone.** The engine has not reached operating temperature yet. Avoid high engine speeds and stressing the engine if it has not reached operating temperature.

- B Normal zone.** At high outside temperatures and when making the engine work hard, the diodes may continue lighting up and reach the upper zone. This is no cause for concern, provided the control lamp does not light up .
- C Warning area.** When the engine is working hard, especially at high outside temperatures, the diodes may light up in the warning area.

The coolant temperature gauge only works when the ignition is switched on.

In vehicles with digital instrument cluster you can select to view the coolant temperature in the corresponding menu **>>> page 18.**


Control and warning lamps**Fault in the engine coolant system**

The LED flashes red.

Engine coolant

The lamp lights up red.

The motor coolant temperature is too high or the motor coolant level is too low.

-  **Stop driving!** Stop the vehicle at the next opportunity and in a safe place.
- Switch off the engine and let it cool down.
- Check the coolant level in the coolant expansion tank **>>> page 330.**

If the warning lamp does not go out even though the motor coolant level is correct, do not continue to drive or leave the motor running. Seek specialist assistance.

Control and warning lamps (valid for hybrid vehicles)

together with

**Fault in the high-voltage cooling circuit**


The warning lamps flash red.

Engine coolant

The lamp lights up red.



Engine or high-voltage system coolant level too low, engine or high-voltage system coolant temperature too high.

-  **Stop driving!** Stop the vehicle at the next opportunity and in a safe place.
- Switch off the engine and let it cool down.
- Check the coolant level in the coolant expansion tank **>>> page 330.**
- Check the coolant level in the high-voltage cooling circuit **>>> page 330.** If the level is too low **DO NOT add coolant.** Seek specialist assistance immediately.

If the warning lamp does not go out even though the motor coolant level is correct, do not continue to drive or leave the motor running. Seek specialist assistance.

NOTICE

- To ensure a long useful life for the engine, avoid high revs, driving at high speed and making the engine work hard for approximately the first 15 minutes when the engine is cold. The phase until the engine is warm also depends on the outside temperature. If necessary, use the engine oil temperature as a guide >>> page 25.
- Additional lights and other accessories in front of the air inlet reduce the cooling effect of the coolant. At high outside temperatures and high engine loads, there is a risk of the engine overheating.
- The front spoiler also ensures proper distribution of the cooling air when the vehicle is moving. If the spoiler is damaged this can reduce the cooling effect, which could cause the engine to overheat. Seek specialist assistance.

Power meter

✓ Valid for: hybrid vehicles

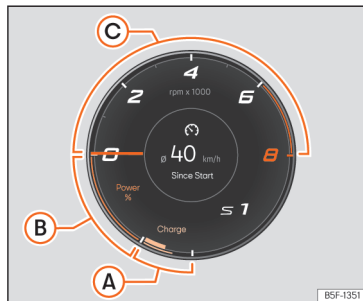


Fig. 10 Digital instrument cluster: Power meter

The lower left hand side of the rev counter has two colour coded areas:

Green Charge: Energy recovery zone.

Blue Power %: Electric traction zone. Indicates the percentage of power used and the maximum amount of power currently available.

The power meter shows the usage level of the electric drive. The power meter bar shows the current usage level.

A finer coloured border indicates how much the propulsion can currently be used. Depending on the selected driving program and the current availability of electrical power, the boundaries of the different colours can vary.


The following displays can be seen on the Power meter: >>> **Fig. 10**..

- A** The vehicle recovers electrical energy.
- B** e-Mode electric driving.
- C** The combustion engine must be running. With the Boost function, the vehicle drives for a short period of time with maximum power from both the electric motor and the combustion engine.

Status display**Possible indications on the instrument panel display**

The instrument cluster can display a variety of information, superimposed according to the vehicle's equipment:

- Doors, bonnet and rear lid open
- Warning and information messages
- Odometer
- Time >>> page 30
- Indications of the radio and navigation system
- Indications of the phone
- Outside temperature

- Compass indication
- Selector lever positions
- Gear-change recommendation
- Combined range (Hybrid vehicles)
- Display of travel data (multifunction display) and menus for different settings >>> **page 25**
- Service interval display >>> **page 31**
- Speed warning
- Speed warning for winter tyres
- Start-Stop system status display >>> **page 159**
- Signs detected by the road signs detection system and warning that the maximum permitted speed has been exceeded >>> **page 28**
- Indication of active cylinder management status (ACT®) >>> **page 147**
- Low consumption driving 
- Assistant systems display


Doors, bonnet and rear lid open

When the vehicle is unlocked and while driving, the instrument panel display shows if any of the doors, the bonnet or rear lid are opened and, in some cases, it is also indicated by an audible warning.

Selector lever positions

The current position of the selector control is shown on the side of the control and on the instrument cluster display. When the control is in the **D/S** position or in the Tiptronic position, in some cases, the gear engaged in each case is shown on the instrument cluster display.

Outside temperature indicator

If the outside temperature is lower than approximately +4 °C (+39 °F), the "ice crystal symbol" ❄️ also lights up on the outside temperature indicator. This symbol remains lit until the outside temperature exceeds +6 °C (+43 °F) >>> .

In the following situations, the displayed exterior temperature may be higher than the actual temperature due to the heat emitted by the motor:

- When the vehicle is stationary.
- When driving very slowly.

Gear-change recommendation

While driving, the instrument panel of certain vehicles may indicate a gear recommendation for saving fuel >>> **page 147**.

Odometer

The *odometer* registers the total distance travelled by the car.

The *trip counter* (**trip**¹⁾) shows the distance travelled since the last time it was reset to zero.

- Set the odometer to zero via the Infotainment system or the multifunction steering wheel >>> **page 25**.

To reset the trip odometer (**trip**) to 0:

- When in **Travel data** select **trip**.
- Hold the **OK/RESET** button on the wiper lever or the **OK** button on the multifunction steering wheel down for about 2 seconds.

Combined operating range display (hybrid vehicles)

The value shown is calculated and updated according to the driving style. Therefore, the range can vary even when the fuel tank is full and the high-voltage battery is fully charged.

Range can be increased by reducing or switching off comfort consumers, e.g. air conditioning or seat heating.

Speed warning for winter tyres

If the maximum set speed is exceeded, this is displayed on the instrument cluster display.

The speed warning can be set in the infotainment system >>> **page 38**.


¹⁾ Applies to vehicles with analogue instrument panel.

Compass indication

Depending on the equipment, when the ignition is on, the instrument panel display indicates the direction in which you are driving with a symbol, e.g. NW for Northwest.

When the Infotainment system is on and there is no route guidance active, the graphic representation of a compass is also shown.

Low consumption driving

Depending on the equipment, when driving, the  display appears on the instrument panel when the vehicle is in low consumption status due to active cylinder management (ACT®)
 >>> page 147.

WARNING

Even when the outside temperature is higher than freezing temperature, some roads and bridges could be frozen.

- The “ice crystal symbol” indicates that there may be a risk of freezing.
- At outside temperatures above +4 °C (+39 °F), there may be ice even when the “ice crystal symbol” is not on.
- The outside temperature sensor takes a guideline measurement.

Note

- There are different instrument panels and therefore the versions and instructions on the display may vary. In the case of displays without warning or information texts, faults are indicated exclusively by the control warning lamps.

- Some indications on the instrument panel screen may be concealed by a sudden event, e.g. an incoming call.

- Depending on the equipment, some settings and instructions can be carried out or displayed on the infotainment system as well.

- If there are several warnings at the same time, the symbols will be displayed one after the other for a few seconds. The symbols will stay on until you remove the cause.

- If when switching on the ignition warnings are shown about existing faults, it might not be possible to change the settings or show the information as described. In this case, go to a specialised workshop and request a repair.

Driving data indicator

The driving data display shows a range of driving data and consumption values.

Change from one display to another

- Turn the right thumbwheel of the multifunction steering wheel >>> page 33.

Changing memory

Vehicles with analogue instrument clusters:

- Press the **OK/RESET** button on the wiper lever or the **OK** button on the multifunction steering wheel.


Vehicles with digital instrument panel:

- Depending on the view, select **Driving data** and press the left arrow or the **OK** button on the multifunction steering wheel.
 - **Since start:** The memory is deleted if the journey is interrupted for more than 2 hours.
 - **Since refuel:** Display and storage of the journey data and the consumption values collected. When refuelling, the memory is deleted.
 - **Long-term:** This memory contains travel data up to a maximum of 19 hours and 59 minutes or 99 hours and 59 minutes, or up to a maximum of 1999.9 km or 9999.9 km. When one of these values is exceeded [varies depending on the version of the instrument panel], the memory is deleted.


Delete journey data presets

- Select the memory that you wish to erase.
- Keep the **OK** button on the multi-function steering wheel pressed for approximately 2 seconds.



Select the instructions

On the instrument cluster, it is selected manually using the  button on the multifunction steering wheel. To access the contents of the tube, rotate the right hand thumbwheel up/down.

- **Current consumption:** The current fuel consumption display operates throughout the journey, in litres/100 km; and with the engine running and the vehicle stopped, in litres/hour.
- **Average consumption:** The average fuel consumption is displayed after driving for approximately 300 metres.
- **Travelling time:** This indicates the hours (h) and minutes (min) since the ignition was switched on.
- **Range:** Approximate distance in km that can still be travelled if the same driving style is maintained.

- **AdBlue range or **: Approximate distance in km that can still be travelled with the current level of the AdBlue® tank with the same driving style. The indication appears from a range of less than 2400 km and cannot be deactivated.¹⁾
- **Distance travelled:** Distance covered in km (m) after switching on the ignition.
- **Average speed:** The average speed will be shown after driving for approximately 100 metres.
- **Boost/Torque:** Indicates the power and torque of the combustion engine (does not indicate electric mode).
- **FAS:** Reduced assistant indication.

Oil temperature display²⁾


The engine reaches its operating temperature when, under normal driving conditions, the oil temperature is between **80°C** (176°F) and **120°C** (248°F). If a great effort is required from the engine and the outside temperature is high, the engine oil temperature may increase. This does not present any problem as long as the warning lamps  or  **»» page 337** do not appear on the display.

Warning and information messages

The system runs a check on certain components and functions when the ignition is switched on and while the vehicle is moving. Faults are displayed on the instrument cluster display as red and yellow warning symbols³⁾ **»» page 13** accompanied by messages and, depending on the case, even an audible warning. The representation of the messages and symbols may vary depending on the version of the instrument panel.

Existing faults can also be checked manually. To do this, open the **Vehicle status** **»» page 32** menu.

Priority 1 warning (in red)

The symbol lights up or flashes (in part accompanied by audible warnings).  **Stop driving!** Danger! Check the fault and eliminate the cause. If necessary, seek professional assistance.

Priority 2 warning (in yellow)

The symbol lights up or flashes (in part accompanied by audible warnings). Operating faults or the lack of operating fluids can cause dam-

¹⁾ Not available in all countries.

²⁾ Only with digital instrument cluster.

³⁾ With an analogue instrument panel, the warnings are always shown in white.

age to the vehicle or a fault. Check the faulty function as soon as possible. If necessary, seek professional assistance.

Reference to information in the owner's manual



Further information on any warnings can be found in the owner's manual.

Information message

It provides information about processes in the vehicle.

Accessing warnings and information

Existing faults can also be checked in the infotainment system:

- Press  >  **Vehicle data** > **Vehicle status** >>> page 37.

Vehicles with analogue instrument clusters: Access the **Vehicle** menu, then press the **OK** button on the multifunction steering wheel or the **OK/RESET** button on the windscreen wiper lever and select **Warning message memories**.

Driver alert system (break recommendation)

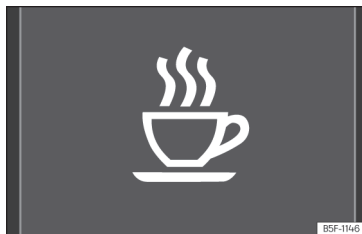


Fig. 11 On the instrument cluster display: driver alert system symbol.

The driver alert system informs the driver when it deduces tiredness due to his/her behaviour at the wheel.

Operation

The driver alert system determines the driving behaviour of the driver at the start of a journey and then calculates the fatigue level. This is constantly compared with the current driving behaviour. If the system detects that the driver is tired, an audible warning is given with a sound and an optical warning is shown with a symbol and supplementary message on the instrument cluster screen >>> **Fig. 11**. The message on the instrument cluster display is shown for approxi-

mately 5 seconds and repeated if necessary. The system stores the last message that is displayed.


The warning on the instrument cluster display can be hidden as follows:

- Press the **OK** button on the multifunction steering wheel.

Operating conditions

Driving behaviour will only be calculated at speeds above approx. 65 km/h (40 mph) up to approx. 200 km/h (125 mph).

Activating and deactivating

Fatigue detection can be activated or deactivated in the infotainment system using the function button  > **Assistants** > **Driver alerts**.

The driver alert system is always switched on when the ignition is switched on >>> **page 38**.

Operating restrictions

The driver alert system has certain limitations inherent to the system. The following conditions may cause the driver alert system to be limited or not to function:

- Speeds below 60 km/h (40 mph).
- Speeds above 200 km/h (125 mph).
- On curvy roads.
- In sections with roadworks.
- On roads in poor condition.

- In unfavourable weather conditions.
- With a sporty driving style.
- If the driver is seriously distracted.

The driver alert system is reset when the vehicle has been stationary for more than 15 minutes, the ignition is switched off or the driver has unfastened the seat belt and opened the door.

In the event of slow driving during a long period of time (below 60 km/h, 40 mph) the system automatically resets the tiredness calculation. When driving faster, driving behaviour will be recalculated.

WARNING

The smart technology of the driver alert system cannot overcome the limits imposed by the laws of physics and only works within the limits of the system. The increased comfort provided by the driver alert system should not lead you to take any risks. On long journeys, take regular and sufficiently long breaks.

- It is always the driver's responsibility to be fully capable of driving.
- Never drive if you are tired.
- The system does not detect driver fatigue in all circumstances. Consult the information in the section »» page 27, *Operating conditions*.
- In some situations, the system may misinterpret an intentional driving manoeuvre as driver fatigue.

- **There is no warning of the micro-sleep phenomenon!**
- **Please observe the indications on the instrument panel and act as is necessary.**

Note

- **Fatigue detection has only been developed for driving on motorways and well-paved roads.**
- **If there is a fault in the system, have it checked by a specialised workshop.**

Road signs detection system



Fig. 12 On the instrument cluster display: examples of recognised signs.

The dynamic road signs display records standard road signs using a camera fitted to the base of the interior mirror, and provides information about speed limits, overtaking prohibitions and warning signs that it recognises.

Within its limitations, the system also displays an additional sign to indicate aspects such as temporary prohibitions. Even on routes without signs, the system can, if necessary, display the applicable speed limits.

The dynamic road sign display system is activated whenever the ignition is switched on.

Traffic sign recognition does not work in all countries. Keep this in mind when travelling abroad.

Shown on the display

In Germany, on motorways and normal roads for vehicles, besides speed limits and overtaking provisions the system also displays end of restriction signs. In all other countries the currently valid speed limit is displayed instead.

The road signs detected by the system are displayed on the instrument cluster display »» Fig. 12 and, depending on the navigation system fitted in the vehicle, in the infotainment system as well.

Road sign detection system messages:

There are no road signs available

- The system is in its start-up phase.
- **OR:** the camera has not recognized any mandatory or prohibitive signs.

Error: Dynamic road sign display

- There is a fault in the system. Have the system checked by a specialised workshop.

Speed warning is currently unavailable

• The speed warning function of the road sign detection system is faulty. Have the system checked by a specialised workshop.

Dynamic road sign display: Clean the windscreen!

• The windscreen is dirty in the camera area or the camera's visibility is impaired by weather conditions. Clean the windscreen.

Dynamic road sign display: Currently restricted

- The navigation system is not transmitting data. Check if the navigation system has updated maps.
- **OR:** the vehicle is in a region not included on the navigation system's map.

No data available

- The traffic sign recognition system does not work in the country you are currently driving in.

Display of traffic signs

After checking and evaluating the information from the camera, the infotainment system and actual vehicle data, the system displays up to two current road signs, and a generic additional sign »» Fig. 12:

- **First:** The sign that is currently valid for the driver is displayed on the left hand side of the screen, e.g. a prohibition of driving at over 130 km/h (80 mph).


• **Second:** Another traffic sign, such as a warning sign, can be displayed in second place.

• **Additional sign:** If the windscreen wiper is operating while driving, the signal with the rain sub-plate shall be displayed first on the left-hand side as it is the main signal at that time. A sign valid only with restrictions, e.g. no overtaking at certain times, may be displayed.

The warning sign display is not available in all countries and the system may not be able to detect all existing warning signs.


Speed warning

If the system detects that the permitted speed is exceeded, it may warn the driver with a "gong" and visually with a message on the dash panel display.

The speed warning can be set or deactivated completely in the menu  > **Assistants** > **Driver alerts** > **Road sign detection** »» page 38. The speed warning can be set to a value of 0, 5 or 10 km/h (0, 3 or 5 mph) above the permitted speed.

Trailer mode

For vehicles with a factory-fitted tow-bar and an electrically connected trailer, the display of traffic signs specific to vehicles with a trailer, such as speed limits or overtaking prohibitions, can be activated or deactivated.

It can be activated or deactivated in the infotainment system using the button  > **Assistants** > **Driver warnings** > **Road sign detection** > **Consider trailer** »» page 38.

For the trailer mode, the display of the applicable speed restrictions can be adjusted for the type of trailer or to meet legal regulations. The speed is adjusted in steps of 10 km/h (5 mph) within the range between 60 and 130 km/h (40 and 80 mph). If it is adjusted to a speed greater than that which is permitted in the country in question for driving with a trailer, the system automatically displays the usual speed limits, e.g. in Germany 80 km/h (50 mph).

If the speed warning for the trailer is deactivated, the system displays the speed restrictions as if no trailer is being towed.

No entry sign

The traffic sign recognition system gives a warning on the instrument cluster when a no entry sign is passed on a one-way road or an entrance to a motorway or highway.

Limited operation

The road sign detection system has certain limitations. The following cases may cause the system to function in a limited way or not at all:

- Poor visibility, e.g. in snow, rain, fog or intense mist.
- Dazzling, e.g. caused by head-on traffic or by the sun.
- Driving at high speed.
- If the camera is covered or dirty.
- If the traffic signs are partially or totally obstructed, e.g. by trees, snow, dirt or other vehicles.
- Non-compliant road signs.
- Damaged or bent road signs.
- Variable message signs on signalling gantries (variable indication of road signs by LEDs or other lighting units).
- If outdated maps are used in the navigation system.
- Adhesives affixed to vehicles that depict traffic signs, e.g. speed limits on lorries.

WARNING

The technology in the traffic sign detection system cannot change the limits imposed by the laws of physics and only works within the system's limits. The increased convenience provided by the dynamic road sign display system should not lead you to take any risks. The system is not a replacement for driver awareness.

- Adapt your speed and driving style to suit visibility, weather, road and traffic conditions.
- Poor visibility, darkness, snow, rain and fog may result in the system not displaying road signs, or not displaying them correctly.
- If the camera's field of view is dirty, covered or damaged, the operation of the system may be affected.

WARNING

The driving recommendations and traffic indications shown on the traffic sign detection system may differ from the actual current traffic situation.

- The system cannot recognise or display all road signs correctly.
- Traffic signs and traffic regulations have priority over the recommendations and displays provided by the system.

Note



To avoid affecting the correct operation of the system, take the following points into consideration:

- Clean the camera's field of vision regularly and keep it clear, with no snow or ice.
- Do not cover the field of vision of the camera.


- Always replace damaged or worn wiper blades in a timely manner to avoid streaks in the camera's field of vision.
- Check that the windscreen is not damaged in the area of the camera's field of vision.
- The use of old maps in the navigation system may cause road signs to be displayed incorrectly.
- The dynamic road sign display system is only available to a limited extent in navigation mode with waypoints in the navigation system.

Time and date

Setting the time on the infotainment system

- Press  >  Settings >>> page 33.
- Select the menu option **Date and time**.

Setting the time on analogue the instrument panel

- When in the **Driving data** menu, select the Range function ( > **Interior** > **Instrument cluster**).
- Press the button **OK** on the multifunction steering wheel until the Service menu is displayed on the instrument panel display >>> page 31.
- Select the menu **Time**.
- Adjust the correct time by turning the right thumbwheel of the multifunction steering wheel.

Service Menu

In the Service menu various settings can be adjusted depending on the features.

Open the Service menu

Vehicles with digital instrument panel:

- While in **Classic View**, go to the **Initial Data** screen, press the **OK** button on the multifunction steering wheel for about 5 seconds and release it.
- Next, the **Configuration List** menu is displayed, where you can choose between the **Service menu** or the **View selection** from where the instrument cluster views can be switched on and off.
- *Vehicles with analogue instrument clusters:*
- To open up the **Service** menu, select the **Range** information profile while in the **Driving data** menu, and keep the **OK** key pressed on the multifunction steering wheel for approximately 5 seconds. When it is released, the **Service** menu will be displayed. Now you can browse through the menu using the keys on the multifunction steering wheel as usual.

Restart the service interval display

Select the **Service** menu and follow the instructions on the screen of the instrument panel.

Restart the oil service

Select the **Reset Oil service** menu and follow the instructions on the instrument panel display.

Reset driving data (vehicles with an analogue instrument cluster)

Select the **Reset trip** menu and follow the instructions on the instrument panel display to reset the value.

Identifying letters on engine (LDM)

Select the menu **Engine code**. The identifying letters of the engine will be shown on the instrument cluster display at the bottom left.

Next Service

This specifies when the next workshop inspection is scheduled.

Service intervals

The service interval display appears on the instrument cluster screen and in the infotainment system.

There are different versions of instrument panels and infotainment systems, so the versions and instructions on the screens may vary.

SEAT distinguishes between services with engine oil change (e.g. Oil change service) and services without engine oil change (e.g. Inspection).

In vehicles with **Services established by time or mileage**, the service intervals are already pre-defined.


In vehicles with **LongLife Service**, the intervals are determined individually. Thanks to technological progress, maintenance work has been greatly reduced. The oil only needs to be changed when the vehicle requires it. To calculate this variation (max. 2 years), the vehicle's conditions of use and individual driving styles are considered. The advance warning first appears 20 days before the date established for the corresponding service. The kilometres (miles) remaining until the next service are always rounded up to the nearest 100 km (miles) and the time is given in complete days. The current service message cannot be viewed until 500 km after the last service. Prior to this, only lines are visible on the display.

Inspection reminder

If a service or an inspection has to be carried out soon, a **service reminder** will be displayed when the ignition is switched on.

The figure displayed are the kilometres that can still be travelled or the time until the next service.

Service due

When **it is time for a service** or an **inspection**, an audio warning will sound when the ignition is switched on, and a spanner symbol may appear for a few seconds on the instrument cluster display , along with one of the following messages.

- **Service now!**
- **Please have your vehicle inspected**
- **Oil change service due!**
- **Oil change service and inspection due!**

Consult a service notification

With the ignition switched on, the engine off and the vehicle at a standstill, the current service notification can be read:

Check the date of the current service on the infotainment system:

- Press **Settings**.
- Select the **Data connection** menu option to display information about services.

Checking the date on the digital instrument panel:

- The date of the service can only be read through the **Service >>> page 31** menu.

Checking the date on the digital instrument panel:

- Press and hold the **OK** button on the multifunction steering wheel for more than 5 seconds to consult the service message.

Resetting service interval display

If the service was **not** carried out by a SEAT dealership, the display can be reset as follows:

Vehicles with digital instrument panel

- The service interval display can only be reset through the **Service >>> page 31** menu.

Vehicles with analogue instrument panel

- While in the **Range >>> page 25** menu, press the **OK** button on the multifunction steering wheel for about 4 seconds and release it. The **Services** menu is accessed.

- Select **Reset Service** or **Reset Oil Service** [depending on the version or what you want to do] and press the **OK** button on the multifunction steering wheel.

- The system will ask **Do you want to reset?**. By pressing the **OK** button again, the Service is reset.

Do not restart the indicator between the service intervals, otherwise the information displayed will be incorrect.

If the oil change service is reset manually, the service interval display changes to a fixed service interval, also in vehicles with **Flexible oil change service**.



Note

- The service message disappears after a few seconds, when the engine is started or when the **OK** button is pressed on the multifunction steering wheel.
- In vehicles with the LongLife system in which the battery has been disconnected for a long period of time, it is not possible to calculate the date of the next service. Therefore the service interval display may not be correct. In this case, bear in mind the maximum service intervals permitted >>> page 362.
- If you reset the display manually, the next service interval will be indicated as in vehicles with fixed service intervals. For this reason we recommend that the service interval display be reset by an authorised dealer.

Instrument cluster operation

Introduction

With the ignition switched on, it is possible to read the different functions of the display by scrolling through the menus.

In vehicles with multifunction steering wheel, the multifunction display can only be operated with the steering wheel buttons.

Some menu options can only be read when the vehicle is at a standstill.

Instrument panel menus

The number of menus and information items available will depend on the vehicle's electronics and features.

- Vehicle status >>> **page 26**.
- Driving data >>> **page 25**.
- Assist systems.
 - Front Assist On/Off >>> **page 193**
 - ACC (only display) >>> **page 185**
 - Lane Assist On/Off >>> **page 197**
 - Side Assist On/Off >>> **page 205**
- Navigation.
- Audio.
- Telephone.

⚠ WARNING

Distracting the driver in any way can lead to an accident and cause injuries.

- **Never use the menus on the instrument panel display while the vehicle is in motion.**

ⓘ NOTICE

After charging or changing the 12-volt battery, check the system settings. If the power supply is interrupted, the system settings might be incorrect or deleted.

Operation using the multifunction steering wheel

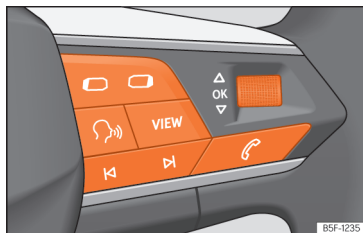




Fig. 13 Right side of multifunction steering wheel: buttons to the menus and informative indications on the instrument panel (depending on the version).

As long as a priority 1 >>> **page 26** warning is active, it will not be possible to access any menu. Some warnings can be confirmed and hidden with the button **OK** of the multifunction steering wheel >>> **Fig. 13**.

Select a menu or an informative display

- Switch the ignition on.
- If a message or vehicle symbol is displayed, press the button **OK** >>> **Fig. 13**; several times if necessary.
- To change menus, use buttons  or .

- To open the menu or the information displayed, press the button **OK** or wait a few seconds until the menu or the informative display opens automatically.

Changing menu settings

- In the menu displayed, turn the right thumbwheel of the multifunction steering wheel until the desired option of the menu is highlighted. The option appears framed.
- Press the button **OK** to make the required modifications. A mark indicates that the system or function is activated.

Back to menu selection

- Press the button  or .

Infotainment system operation and displays

Introduction

The infotainment system brings together important vehicle functions and systems into a single central control unit, e.g. air conditioning, menu settings, radio equipment and the navigation system.

The actual number of menus available and the name of the various options will depend on the vehicle's electronics and equipment.

General operating information

General information on the operation of the infotainment system, as well as on the warning and safety instructions that must be taken into account, is found in >>> page 250.

How to move through the different menus and select them

- Switch the ignition on.
- If the infotainment system is off, switch it on.
- The different menus are selected directly on the touch screen using texts, icons or buttons.

If the box is checked ✓, the function is activated.

Pressing the menu button < will always take you to the last menu used.

Any changes made using the settings menus are automatically saved on closing those menus

Scroll bar: Some menus and functions show more content above or below those displayed on the screen at that time, for example, long lists of settings. Press on the scroll bar and pull up or down.

Tutorial

The first time you connect the Infotainment system, a system tutorial will open with a brief description of the main functions and how to use it.

Help

In the **Help** menu can be found more information and tips for using the infotainment system.

WARNING

Any distraction may lead to an accident, with the risk of injury. Operating the Infotainment system while driving could distract you from traffic.

Note

After starting the engine with a 12-volt battery that is heavily discharged or recently replaced, some system settings such as time, date, personalised comfort settings, programming and user accounts might be altered or deleted. Check and correct these settings when the battery is sufficiently charged.

Explanation of the function buttons

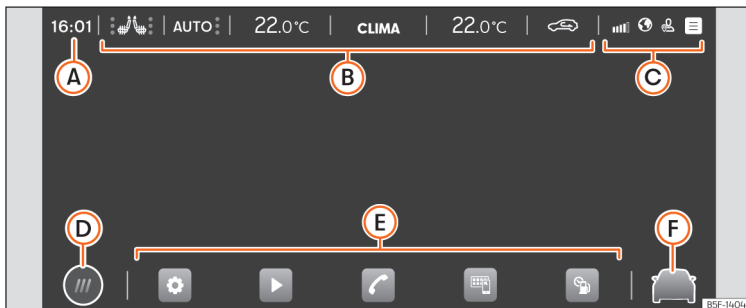


Fig. 14 Schematic diagram: Overview of the possible function buttons on the screen

Top part of the screen

The following information is always visible, even when the infotainment system is turned off

»» **Fig. 14:**

- A** **Time, Incoming call, or, pre-air conditioning on/off.**
- B** **Climabar** »» page 139.
- C** **Status bar.** Information bar showing the system status, such as: phone coverage, phone charge level, Qi charger status, user privacy mode, system notifications, incoming calls and access to the call control unit.

Bottom part of the screen

Valid for the infotainment system: Connect System.

- D** **Main menu display mode:**
 @: main menu with the 6 main functions divided into 2 screens (3 + 3, customisable by the user by pressing on the function).
 ⊕: main menu in tile mode (all functions of the Infotainment system)
- E** **Direct accesses to the functions of the Infotainment system** (up to 5 functions). By clicking on the icon you can access the functions or context in question.
- F** **Direct access to the assistants and vehicle settings** »» page 38.

Initial configuration wizard

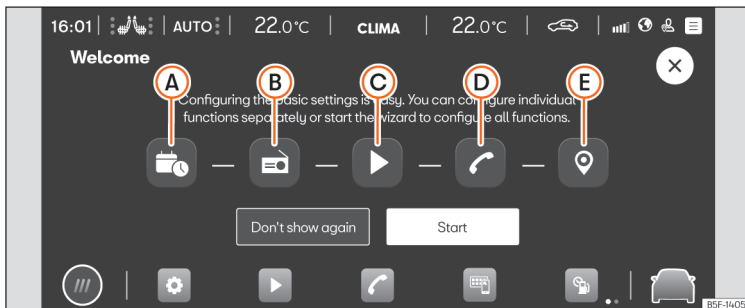


Fig. 15 Schematic representation: Initial configuration wizard

The initial configuration wizard will help you to set up your Infotainment system the first time you switch it on.

Whenever you switch on the infotainment system, the initial setup screen will be displayed
 >>> **Fig. 15** if any parameters have not been set (marked with "✓") or if the **Don't show again** function button has not been pressed.

Function buttons:

- A** Press to set day and time.
- B** Press to search and store to memory the radio stations that have the best reception at that moment.
- C** Press to go to the Online Media settings.
- D** Press to link your mobile phone to the Infotainment system.

- E** Press to select your home address using your current position or by manually entering an address.

Don't show again Disables the possibility of changing the settings of the Infotainment system. If you wish to perform the initial configuration, you must access through **Help**.

Start Starts up the Configuration Wizard.

End Once one or more settings have been applied, press to finalise the setup in the main menu of the wizard.

- X** Closes the Configuration Wizard.

Vehicle information

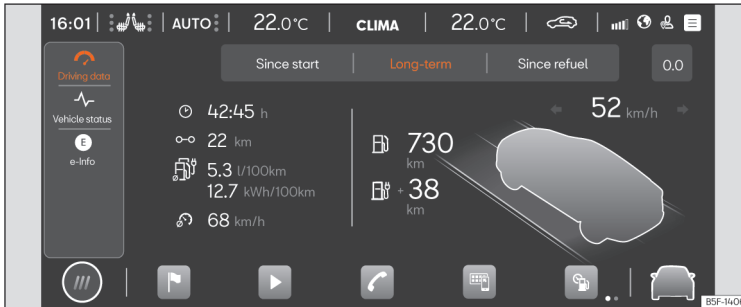



Fig. 16 Schematic diagram: Vehicle information and status.

Pressing on  **Vehicle info** in the main menu opens the **Vehicle info** menu with the following submenus:

- **Driving data:** The average consumption, average speed, distance travelled, trip duration and autonomy are shown. It has 3 memories: "Since start", "Long-term" and "Since refuelling".
- **Vehicle status:** The warnings regarding faults, incidents, memorisation of the tyre pressure or information of the next inspection service are displayed.
- **e-Info:** Shows the electric range and power flow.

Assist systems and vehicle settings

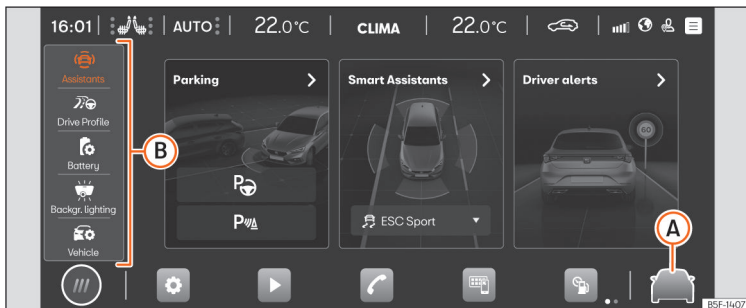


Fig. 17 Schematic diagram: Assistants and vehicle settings

Press **Fig. 17 (A)**, or **Vehicle settings** in the main menu to open the assistants and vehicle settings menu. Next, clicking on any of the menus located in the left area **(B)**, displays the settings menu or the selected assist systems on the display.

The number of assist systems and settings depend on the version and the country in question.

Assistance systems

• Parking

- Automatic parking brake activation **>>> page 209.**
- Park assist **>>> page 213.**
- Rear Cross Traffic Alert **>>> page 227.**

• Smart Assistants

- Activate / deactivate ESC, stabilisation systems and brake assist **>>> page 173.**
- Switch the Start-Stop system on / off **>>> page 159**
- Adaptive cruise control (ACC) **>>> page 185.**
- Lane Assist **>>> page 197.**
- Emergency braking assist system Front Assist **>>> page 193.**
- Driving assistant (Travel Assist) **>>> page 199**
- Emergency Assist **>>> page 203**
- Hill descent control (HDC).
- Predictive speed adjustment **>>> page 191.**

• Driver alerts

- Fatigue detection **>>> page 27.**
- Dynamic road sign display **>>> page 28.**
- Side Assist **>>> page 205.**
- Eco-efficient driving assistant **>>> page 184**

Drive Profile >>> page 170

Battery manager >>> page 81

Background lighting >>> page 124

Settings

- Instrument cluster **>>> page 23.**
- Lighting **>>> page 123.**
- Mirrors **>>> page 128.**
- Closing **>>> page 87.**

- Lights »» page 118.
- Windows »» page 128.
- Tyres »» page 357.
- Windscreen wipers »» page 126
- Electric drive (PHEV hybrid vehicles) .
- Seats »» page 111

Departure menu

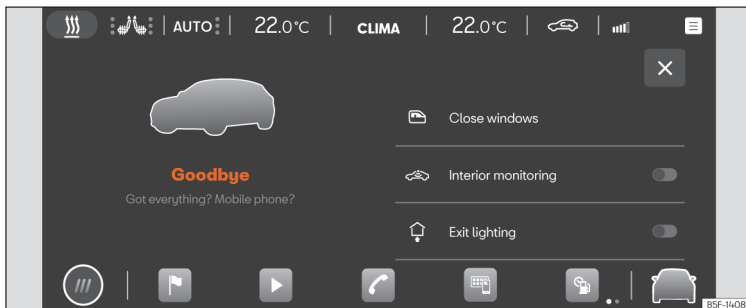


Fig. 18 Schematic representation: departure menu.

In the departure menu you can set some functions before leaving the vehicle. When you switch off the ignition, the departure menu is displayed on the infotainment system.

The inputs that are displayed depend on the equipment and, if applicable, are only available under certain conditions. Examples of adjustable functions are:

- Close windows
- Interior monitoring
- Exit lighting

Hide

When you leave the vehicle, the departure menu is hidden automatically. Depending on the equipment, it is also hidden after a certain amount of time.

- Press X to manually hide the departure menu.

Safety

Safe driving

Safety first!

WARNING

- This manual contains important information about the operation of the vehicle, both for the driver and the passengers. The other sections of the on-board documentation also contain further information that you should be aware of for your own safety and for the safety of your passengers.
- Ensure that the on-board documentation is kept in the vehicle at all times. This is especially important when lending or selling the vehicle to another person.

Before driving

For your own safety and the safety of your passengers, always note the following points before every trip:

- Make sure that the vehicle's lights and turn signals are working properly.
- Check tyre pressure.
- Ensure that all windows provide a clear and good view of the surroundings.

- Make sure all luggage is secured >>> page 282.
- Make sure that no objects can interfere with the pedals.
- Adjust front seat, head restraint and mirrors properly according to your size.
- Ensure that the passengers in the rear seats always have the head restraints in the in-use position >>> page 113.
- Instruct passengers to adjust the head restraints according to their height.
- Protect children with appropriate child seats and properly applied seat belts >>> page 59.
- Assume the correct sitting position. Instruct your passengers also to assume a proper sitting position >>> page 42.
- Fasten your seat belt securely. Instruct your passengers also to fasten their seat belts properly >>> page 44.

Factors influencing safety

As a driver, you are responsible for yourself and your passengers.

- Always pay attention to traffic and do not get distracted by passengers or telephone calls.
- Never drive when your driving ability is impaired (e.g. by medication, alcohol, drugs).
- Observe traffic laws and speed limits.

- Always reduce your speed as appropriate for road, traffic and weather conditions.
- When travelling long distances, take breaks regularly - at least every two hours.
- If possible, avoid driving when you are tired or stressed.

WARNING

Driving under the influence of alcohol, drugs, medication or narcotics may result in severe accidents and even loss of life.





- **Alcohol, drugs, medication and narcotics may significantly alter perception, affect reaction times and safety while driving, which could result in the loss of control of the vehicle.**

Safety equipment

Never put your safety or the safety of your passengers in danger. In the event of an accident, the safety equipment may reduce the risk of injury. The following points cover part of the safety equipment in your SEAT¹⁾:

- Optimised seat belts for all seats.
- Seat belt tensioners on the driver, front passenger and rear side seats.
- Seat belt force limiters on the driver, front passenger and rear side seats.

¹⁾ Depending on the version/market.

- Red warning lamp  and, if applicable, seat belt status indication.
- Front airbags for driver and passenger.
- Side airbags for driver and passenger.
- Side airbags for the rear seats.
- Head airbags on both sides of the vehicle.
- Central airbag between the driver and front passenger.
- Knee airbag.
- Yellow airbag control lamp .
- Yellow warning lamp **PASSENGER AIR BAG OFF**  on the roof console.
- Yellow warning lamp **PASSENGER AIR BAG ON**  on the roof console.
- Control units and sensors.
- Optimised and height-adjustable headrests.
- Adjustable steering column.
- ISOFIX/i-Size anchor points for child seats.
- Child seat top tether attachment points.

The safety equipment mentioned above works together to provide you and your passengers with the best possible protection in the event of an accident. However, these safety systems can only be effective if you and your passengers are sitting in a correct position and use this equipment properly.

Safety is everybody's business.

Correct sitting position of vehicle occupants

Correct position on the seat

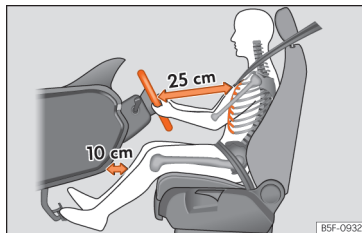


Fig. 19 The correct distance between the driver and the steering wheel must be at least 25 cm [10 inches].

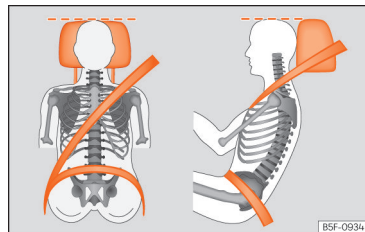


Fig. 20 Correct belt web and headrest positions

The correct sitting positions for the driver and passengers are shown below.

If your physical constitution prevents you from maintaining the correct sitting position, contact a specialised workshop for help with any special devices. The seat belt and airbag can only provide optimum protection if a correct sitting position is adopted. SEAT recommends taking your car in for technical service.

For your own safety and to reduce the risk of injury in the event of an accident or sudden braking or manoeuvre, SEAT recommend the following positions:

Valid for all vehicle occupants:

- Adjust the headrest so that its upper edge is at the same level as the top of your head, or as close as possible to the same level as the top of

your head and under no circumstances below eye level. Keep the back of your neck as close as possible to the headrest >>> **Fig. 20.**

- Short people must fully lower the headrest completely, even if your head is below its upper edge.
- Tall people must fully raise the headrest.
- Always keep your feet in the footwell while the vehicle is in motion.
- Adjust and fasten your seat belt correctly >>> **page 44.**

The following also applies to the driver:

- Move the seat backrest to an almost upright position so that your back rests completely against it.
- Adjust the steering wheel so that it is at a distance of at least 25 cm (10 inches) from the sternum >>> **Fig. 19** and can hold it with both hands on the sides, on the outside, with the arms slightly flexed.
- The steering wheel must always point towards the chest and never towards the face.
- Adjust the seat lengthwise so that you can fully step on the pedals with your knees slightly bent and there is a distance between the knee area and the instrument panel of at least 10 cm (4 inches) >>> **Fig. 20.**

- Adjust the height of the seat so that you can reach the top of the steering wheel.

- Always keep both feet in the footwell so that you have the vehicle under control at all times.

For the passenger, the following applies:

- Move the seat backrest to an almost upright position so that your back rests completely against it.
- Move the seat as far back as possible (minimum 25 cm between the chest and the instrument panel check translation). If you are sitting closer than 25 cm, the airbag system cannot protect you properly.

Number of seats

The vehicle has **5** seats, 2 in the front and 3 in the rear. All seats are equipped with a safety belt.

Check the official documentation for the number of occupants approved for your vehicle.

WARNING

Sitting in an incorrect position may increase the risk of severe or lethal injuries in the event of sudden braking or manoeuvring, in case of collision or accident and if the airbags deploy.

- Before starting the car, all passengers must be sitting in a correct position and stay like that for the entire journey. This also applies to a correct use of the seat belt.
- The maximum amount of people in the vehicle is the same as the amount of seats with seat belts.
- For children, always use a protection system that is approved and suited for their weight and height >>> **page 59.**
- While driving, always keep your feet in the footwell. Never place them over the seat or the dash panel, for example, or outside the window. Otherwise the airbag and seat belt may offer insufficient protection and also increase the risk of injury in the event of an accident.

Risks of sitting in an incorrect position

If seat belts are worn incorrectly or not at all, the risk of severe or lethal injuries increases. Seat belts can provide optimal protection only if the belt web is properly worn. Incorrect sitting positions substantially reduce the protective function of seat belts and, therefore, increase

the risk of severe or even lethal injuries. The risk of severe or fatal injuries is especially heightened when a deploying airbag strikes a vehicle occupant who has assumed an incorrect sitting position. The driver is responsible for all people, particularly children, inside the vehicle.

The following list contains examples of incorrect sitting positions that could be dangerous for all vehicle occupants.

When the vehicle is in motion:

- Never stand in the vehicle.
- Never stand on the seats.
- Never kneel on the seats.
- Never tilt your seat backrest too far to the rear.
- Never lean against the instrument panel.
- Never lie on the rear seats.
- Never sit on the front edge of a seat.
- Never sit sideways.
- Never lean out of a window.
- Never put your feet out of a window.
- Never put your feet on the instrument panel.
- Never place your feet on the bench or on the backrest of the seat.
- Never travel in a footwell.
- Never sit on the armrests.
- Never travel without wearing the seat belt.
- Never travel in the luggage compartment.

WARNING

Sitting in an incorrect position increases the risk of severe or fatal injuries in the event of accidents and sudden braking or manoeuvres.

- All occupants must sit correctly during the journey and wear the seat belt correctly.
- Occupants of the vehicle that are not sitting correctly, not wearing the seat belt or are not at a proper distance of the airbag risk suffering very serious or lethal injuries, especially if the airbags deploy and strike them.

Seat belts

Introduction

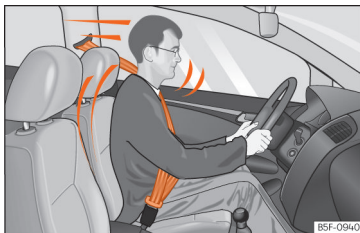


Fig. 21 Drivers with properly worn seat belts will not be thrown forward in the event of sudden braking.

Properly worn seat belts hold the occupants in the proper position. They also help prevent uncontrolled movements that may result in serious injury and reduce the risk of being thrown out of the vehicle in case of an accident.

Vehicle occupants wearing their seat belts correctly benefit greatly from the ability of the belts to absorb kinetic energy. In addition, the front part of your vehicle and other passive safety features (such as the airbag system) are designed to absorb the kinetic energy released in a collision. Taken together, all these features reduce the releasing kinetic energy and consequently, the risk of injury. This is why it is so important to fasten seat belts before every trip, even when "just driving around the corner".

Ensure that your passengers wear their seat belts as well. Accident statistics have shown that wearing seat belts is an effective means of substantially reducing the risk of injury and improving the chances of survival when involved in a serious accident. Furthermore, properly worn seat belts improve the protection provided by airbags in the event of an accident. For this reason, wearing a seat belt is required by law in most countries.

Although your vehicle is equipped with airbags, the seat belts must be fastened and worn. The front airbags, for example, are only triggered in some cases of head-on collision. The front airbags will not be triggered during minor frontal or side collisions, rear-end collisions, overturns or accidents in which the airbag trigger threshold value in the control unit is not exceeded.

Important safety instructions for the use of seat belts

- Always wear the seat belt as described in this section.
- Ensure that the seat belts can be fastened at all times and are not damaged.

WARNING

- If seat belts are worn incorrectly or not at all, the risk of severe injuries increases. The optimal protection from seat belts can be achieved only if you use them properly.
- Never allow two passengers (even children) to share the same seat belt.
- Never unbuckle a seat belt while the vehicle is in motion. Risk of fatal injury.
- The seat belt should never lie on hard or fragile objects (such as glasses or pens, etc.) because this can cause injuries.
- Do not allow the seat belt to be damaged or jammed, or to rub on any sharp edges.
- Never wear the seat belt under the arm or in any other incorrect position.
- Bulky and unfastened clothing (such as an overcoat over a sweater) impairs the proper fit and function of the seat belts, reducing their capacity to protect.
- The slot in the seat belt buckle must not be blocked with paper or other objects, as this can prevent the latch plate from engaging securely.

- Never use seat belt clips, fastening rings or similar items to alter the position of the belt webbing.
- Frayed or torn seat belts or damage to the connections, belt retractors or parts of the buckle could cause severe injuries in the event of an accident. Therefore, you must check the condition of all seat belts at regular intervals.
- Seat belts which have been worn in an accident and have been stretched must be replaced by a specialised workshop. Renewal may be necessary even if there is no apparent damage. The belt anchorage should also be checked.
- Do not attempt to repair a damaged seat belt yourself. The seat belts must not be removed or modified in any way.
- The belts must be kept clean, otherwise the retractors may not work properly.

Seat belt buckled indication




It lights up red


The driver or one of the passengers have not fastened their seat belts.

The control lamp  lights up to remind the driver to fasten their seat belt.

Before starting the vehicle:

- Fasten your seat belt securely.
- Instruct your passengers to fasten their seat belts properly before driving off.
- Protect children by using a child seat according to the child's height and weight **>>> page 59.**

When starting to drive, if the vehicle's speed exceeds approx. 25 km/h (15 mph) and the seat belts are not fastened or are unfastened while driving, a warning sound will be heard for a few seconds. In addition, the warning lamp  on the instrument cluster display flashes.


The lamp  goes out when the ignition is on and all occupants have fastened their seat belts.


Rear seat belts fastened display




Fig. 22 Instrument cluster: indication of the status of the rear seat seat belts.

Depending on the version of the model, when the ignition is switched on, the status display of the belts >>> **Fig. 22** informs the driver on the instrument panel display whether the occupants of the rear seats have their seat belts fastened.

 Indicates that the corresponding seat is empty.

 Indicates that the seat is occupied and the occupant is wearing the seat belt.

If a rear seat occupant unfastens his/her seat belt while driving, the  symbol lights up for a maximum of 60 seconds. If you drive faster than approx. 25 km/h (15 mph), an audio signal sounds for a few seconds.

If a seat belt is fastened or unfastened while driving in any of the rear seats, the seat belt status is displayed for approximately 30 seconds.

Head-on collisions and the laws of physics

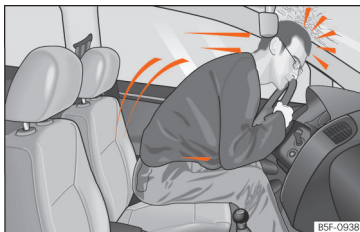


Fig. 23 A driver not wearing a seat belt may be thrown forward violently.



Fig. 24 Any rear seat occupants not wearing a seat belt may be thrown forward violently, hitting the driver who is wearing the seat belt.

The effects of the laws of physics in the case of a head-on collision are easy to explain: the moment a vehicle starts moving, a type of energy called "kinetic energy" starts acting on both the vehicle and its passengers.

The amount of "kinetic energy" depends on the speed of the vehicle and on the weight of the vehicle and of its passengers. The higher they are, the more energy there is to be "absorbed" in the event of an accident.

The most significant factor, however, is the speed of the vehicle. If the speed doubles from 25 km/h (15 mph) to 50 km/h (30 mph), for example, the corresponding kinetic energy is multiplied by four.

Given that the passengers of the vehicle in our example do not have their seat belts fastened, in the event of a collision the entire amount of the passengers' kinetic energy will be only absorbed by the mentioned impact.

Even at speeds of 30 km/h (19 mph) to 50 km/h (30 mph), the forces acting on bodies in a collision can easily exceed one tonne (1000 kg). At greater speed these forces are even higher.

Vehicle occupants not wearing seat belts are not "attached" to the vehicle. In a head-on collision, they will move forward at the same speed their vehicle was travelling just before the impact. This example applies not only to head-on collisions, but to all accidents and collisions.

Even at low speeds the forces acting on the body in a collision are so great that it is not possible to brace oneself with one's hands. In the

event of a head-on collision, vehicle occupants not wearing a seat belt will be thrown uncontrollably forward and will collide, for example, against the steering wheel, instrument panel or windscreen »» Fig. 23.

It is also important for rear passengers to wear seat belts properly, as they could otherwise be thrown forward violently through the vehicle interior in an accident. If a rear seat occupant is not wearing a seat belt, they are not only endangering themselves but also the occupants of the front seats »» Fig. 24.

Fastening and unfastening the seat belt

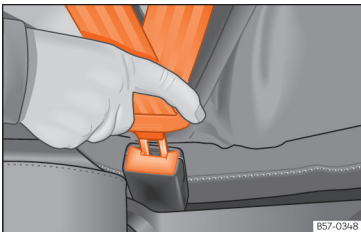


Fig. 25 Insert the latch plate of the seat belt into the buckle.

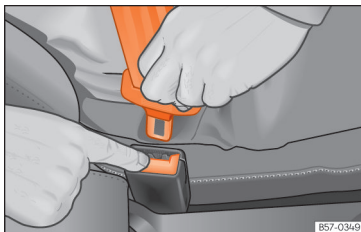


Fig. 26 Release the seat belt's latch plate.

Properly worn seat belts hold the vehicle occupants in the position that most protects them in the event of an accident or sudden braking »» △.

Fastening the seat belt

Fasten your seat belt before each trip.

- Adjust the front seat and head restraint correctly »» page 42.
- Engage the seat backrest of the rear seat in an upright position »» △.
- Pull the latch plate and place the belt webbing evenly across your chest and lap. Do **not** twist the seat belt when doing so »» △.
- Insert the buckle plate in the buckle of the correct seat »» Fig. 25.
- Pull the belt to ensure that the latch plate is securely engaged in the buckle.

Releasing the seat belt

Only unfasten the seat belt when the vehicle has come to a standstill »» △.

- Press the red button on the buckle »» Fig. 26. The latch plate is released from the buckle.
- Guide the belt back by hand so that it rolls up easily and the trim will not be damaged.

⚠ WARNING

- **The seat belt cannot offer its full protection unless the seat backrest is in an upright position and the seat belt is worn correctly, according to your size.**
- **Unbuckling your seat belt while the vehicle is in motion can cause severe or fatal injuries in the event of an accident or sudden braking.**
- **The seat belt itself, or a loose seat belt, can cause severe injuries if the belt moves from hard areas of the body to soft areas [e.g. the stomach].**

Correct position of the seat belt

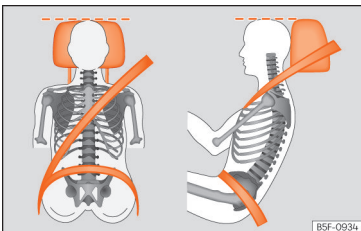


Fig. 27 Correct seat belt and headrest positions, viewed from front and the side.



Fig. 28 Position of seat belt during pregnancy.

Seat belts offer their maximum protection in the event of an accident and reduce the risk of sustaining severe or fatal injuries only when they are properly positioned. Furthermore, if the webbing is correctly positioned, the seat belt

will hold the vehicle occupants in the optimum position to ensure the airbag provides the maximum protection. The seat belt must therefore always be worn and the webbing correctly positioned.

Incorrectly worn seat belts can cause severe or even fatal injuries »» page 42, *Correct sitting position of vehicle occupants*.

- The shoulder part of the seat belt must lie on the centre of the shoulder, never across the neck or the arm, under the arm or behind the shoulder.
- The lap part of the seat belt must lie across the pelvis, never across the stomach.
- The seat belt must lie flat and fit comfortably. Pull the belt tight if necessary to take up any slack.

In the case of **pregnant women**, the seat belt should pass uniformly over the chest and as low as possible through the pelvic area with the strap flat so it does not press down on the abdomen; in addition, it must be used throughout the entire pregnancy »» Fig. 28.

Adapting the position of the belt webbing to your size

The position of the seat belt can be adapted by adjusting the height of the front seats.

WARNING

An incorrectly worn seat belt web can cause severe or fatal injuries in the event of an accident.

- The shoulder part of the seat belt must lie on the centre of the shoulder, never across the neck or the arm.
- The seat belt must lie flat and fit comfortably on the torso
- The lap part of the seat belt must lie across the pelvis, never across the stomach. The seat belt must lie flat and fit comfortably on the pelvis Pull the belt tight if necessary to take up any slack.
- In the case of pregnant women, the abdominal strap of the seat belt should pass as low as possible across the pelvic area, resting flat and “surrounding” the abdomen »» Fig. 28.
- Do not twist the seat belt while it is fastened.
- Once the seat belt is positioned correctly, don't pull it away from your body with your hand.
- Do not lie the seat belt across rigid or fragile objects, e.g. glasses, pens or keys.
- Never use seat belt clips, retaining rings or similar instruments to alter the position of the belt webbing.

Note

If your physical constitution prevents you from maintaining the correct position of the belt webbing, contact a specialised workshop for help with any special devices to ensure the optimum protection of the seat belt and airbag. SEAT recommends taking your car in for technical service.

Automatic retractor, tensioner and belt force limiter

Vehicle seat belts are part of the vehicle's safety system »» page 42. This system has the following important functions:

Automatic belt retractor

The seat belt shoulder straps on the driver's and front passenger seats, as well as those on the rear side seats (and, depending on equipment, also the seat belt of the central rear seat) are fitted with automatic retractors. This device ensures complete freedom of movement when the shoulder strap is pulled gently or during normal driving. However, during sudden braking, when driving in the mountains, around bends and when accelerating, the retractor locks the seat belt if it extends rapidly.

In critical driving situations, e.g. in the event of emergency braking or in the case of oversteer and understeer, the proactive occupant

protection can tension the front seat belts automatically if they are worn¹⁾. The two belts are loosened again if an accident does not happen or when the critical situation passes. Proactive occupant protection is ready to operate again »» page 50.

Seat belt tensioner

The seat belts on the front seats and, depending on the equipment, side rear seats are fitted with tensioners.

The tensioners are activated by sensors in the event of severe head-on, side and rear collisions (in hybrid vehicles they are also activated in the event of a roll-over), and they tension the seat belts in a direction opposite their extension.

If the seat belt is slack, the tensioner tightens it. This cushions the movement of occupants forwards towards the impact.

The belt pre-tensioners work in combination with the airbag system. The belt pre-tensioners activate in combination with some of the airbags, depending on the collision type.

When activated, a fine powder may be released. This is completely normal and it is not an indication of fire in the vehicle.

Reversible belt tensioning (proactive occupant protection)

A reversible tensioning of the seat belts may occur in certain driving situations »» page 50. For example:

- in the event of sudden brakes
- in the event of oversteering or understeering
- in the event of minor collisions

Belt force limiter

Depending on the equipment and the country in question, in the event of an accident, the seat belt force limiter reduces the force the seat belt exerts on the body.

Note

- After certain driving situations, the reversible belt tensioners may be left permanently tensioned¹⁾. In this case, to loosen the belt, it must be removed manually while the vehicle is stationary and then replaced correctly.
- The relevant safety requirements must be observed if the vehicle or any components of the system are to be scrapped. Specialised workshops are aware of these requirements.

¹⁾ Only if fitted with the PreCrash System.

Maintenance and disposal of seat belt tensioners

The belt tensioners are components of the seat belts that are installed in the seats of your vehicle. If you work on the belt tensioners or remove and install parts of the system when performing other repair work, the seat belt may be damaged. The consequence may be that, in the event of an accident, the belt tensioners function incorrectly or may not function at all.

So that the effectiveness of the seat belt tensioner is not reduced and that removed parts do not cause any injuries or environmental pollution, regulations, which are known to the specialised workshops, must be observed.

WARNING

Improper handling and home repairs to seat belts, automatic retractors and belt tensioners may increase the risk of serious or fatal injuries. The tensioners may not activate, even though they should, or they may activate unexpectedly.

- Never repair, adjust, or disassemble and reassemble seat belt components or tensioners. Always have this work carried out by a specialist workshop.
- Seat belts, tensioners and their automatic retractors cannot be repaired and have to be replaced.

For the sake of the environment

Airbag modules and belt tensioners may contain perchlorate.

Observe the legal requirements for their disposal.

PreCrash system

How it works

The PreCrash system is an assistance system that activates a series of measures to protect the occupants of the vehicles in potentially risky situations, but which cannot prevent a collision.

It only works completely if no special driving profile is selected and if there are no operating anomalies.

Basic features

Depending on the legal provisions of the country and the features of the vehicle, in critical situations (e.g. in certain cases of emergency braking or loss of control of the vehicle by the driver) the following functions can be activated separately or at the same time when the vehicle is travelling faster than approximately 30 km/h (20 mph).

- Reversible tensioning of front seat belts that are fastened.
- Operation of the hazard warning lights.

- Automatic closing of the windows until they are just cracked open and, depending on the equipment, of the sunroof.
- In the event of overturning, depending on the equipment, activation of the belt tensioners.

Depending on how critical the driving situation is, the belts are either tightened individually, or both belts at the same time.

In addition to Front Assist

In vehicles with Front Assist **>>> page 193**, within the limits of the system, information is assessed on the risk of collision with the vehicle in front. The functions of the PreCrash system may also be activated if there is a high likelihood of a rear-end collision, or during the activation of Front Assist.

In addition to the Emergency Assist system

In vehicles with emergency assist, driver status information is assessed within the limitations of this system. The following PreCrash systems may be activated if a lack of activity is detected:

- Reversible seat belt tensioning of the driver's seat belt.
- Automatic closing of the windows until they are just cracked open and, depending on the equipment, of the sunroof.

Activation of the PreCrash system

The PreCrash system can be partially deactivated by deactivating the traction and/or stability control, depending on the equipment. When these vehicle safety controls are switched on (by default, every time the ignition is turned on), the system is fully activated.

Driving profile selection settings

In vehicles with driving profile selection, Pre-Crash adapts to suit the special vehicle configuration of the corresponding profile
 >>> page 170.

Limited operation

The PreCrash system is not available or only has limited availability in the following situations:

- When the TCS and/or ESC is off.
- When driving in reverse.
- When the airbag control unit is not operating properly.
- When there is a fault in the system itself, in the ESC or in the Front Assist.

Troubleshooting

If the PreCrash is not working correctly, the message **System unavailable** or **System with limited functions** is shown permanently on the instrument cluster screen. Get the system checked by a SEAT Official Service.

WARNING

The PreCrash system cannot overcome the limits imposed by the laws of physics; it only works within the limits of the system. Risks that compromise safety are never justified by the use of this system. The system is not a replacement for driver awareness and cannot prevent a collision.

- Adapt your speed and safe distance to the vehicle in front of you at all times to suit the visibility, weather, road and traffic conditions.
- The system is not always able to recognise objects.
- The system may not react to people or animals or objects that cross length-wise or that are hard to detect.
- Metallic objects (e.g. fences) or other elements of the public road or adverse weather conditions can hinder its operation and thus its ability to detect collision risk.
- Never ignore the warning lamps that light up or the messages shown on the dashboard.

WARNING

Distracting the driver in any way can lead to an accident and cause injuries.

- Never change settings on the Infotainment System while driving.

Airbag system

Why is it so important to wear a seat belt and to sit correctly?

For the inflating airbags to achieve the best protection, the seat belt must always be worn properly and the correct sitting position must be assumed.

The airbag system is not a substitute for seat belts, but it is an integral part of the vehicle's overall passive safety system. Please bear in mind that the airbag system can only work effectively when the vehicle occupants are wearing their seat belts correctly and have adjusted the head restraints properly. Therefore, it is most important to properly wear the seat belts at all times, not only because this is required by law in most countries, but also for your safety
 >>> page 44, *Seat belts*.

The airbag inflates in a matter of seconds, so if you are not properly seated when the airbag is triggered, you may sustain fatal injuries. Therefore, it is essential that all vehicle occupants assume a correct sitting position while travelling.

Sharp braking before an accident may cause a passenger not wearing a seat belt to be thrown forward into the area of the deploying airbag. In this case, the inflating airbag may inflict critical or fatal injuries on the occupant. This also applies to children.

Always maintain the greatest possible distance between yourself and the front airbag. This way, the front airbags can completely deploy when triggered, providing their maximum protection.

The most important factors for triggering the airbag are the type of accident, the angle of impact and the vehicle speed.

Whether or not the airbags are activated depends primarily on the vehicle deceleration rate resulting from the collision and detected by the control unit. If the vehicle deceleration occurring during the collision and measured by the control unit remains below the specified reference values, the front, side and/or curtain airbags will not be triggered. Take into account that the visible damage in a vehicle involved in an accident, no matter how serious, is not a determining factor for the airbags to have been activated.

WARNING

Wearing the seat belt incorrectly or assuming an incorrect sitting position can lead to critical or fatal injuries


- All vehicle occupants, including children, who are not properly belted can sustain critical or fatal injuries if the airbag is triggered. Children up to 12 years old should always travel on the rear seat. Never transport children in the vehicle if they are not restrained or the restraint system is not appropriate for their age, size or weight.

- To reduce the risk of injury from an inflating airbag, always wear the seat belt properly >>> page 44.

Description of the airbag system

The airbag system offers additional protection for the occupants in combination with the seat belts.

The airbag system comprises the following modules (as per vehicle equipment):

- Electronic control unit
- Front airbags for driver and passenger
- Knee airbag for the driver
- Side airbags
- Central airbag for the driver
- Head airbag
- Airbag control lamp  on the instrument panel >>> page 53
- Key-operated switch for front passenger airbag
- Control lamp for disabled/enabled status of the front passenger airbag.

The airbag system operation is monitored electronically. The airbag control lamp will illuminate for a few seconds every time the ignition is switched on (self-diagnosis).

There is a fault in the system if the control lamp :

- does not light up when the ignition is switched on >>> page 53,
- turns off after 4 seconds after the ignition is switched on,
- turns off and then lights up again after the ignition is switched on,
- illuminates or flashes while the vehicle is moving.

The airbag system is not triggered if:

- the ignition is switched off
- there is a minor frontal collision
- there is a minor side collision
- there is a rear-end collision
- in the event of the vehicle overturning if the dynamic characteristics measured by the control unit are too low,
- the impact speed is lower than the reference value programmed in the control unit.

WARNING

- The seat belts and airbags can only provide maximum protection if the occupants are seated correctly >>> page 42.
- If a fault has occurred in the airbag system, have the system checked immediately by a specialised workshop. Otherwise there is a danger that during a collision, the system may fail to trigger, or not trigger correctly.

Airbag activation

The airbags deploy extremely rapidly, within thousands of a second, to provide additional protection in the event of an accident. A fine dust may develop when the airbag deploys. This is normal and it is not an indication of fire in the vehicle.

The airbag system is only ready to function when the ignition is on.

In special accidents instances, several airbags may activate at the same time.

In the event of minor head-on and side collisions, rear-end collisions, overturning or rollover of the vehicle, airbags **do not activate**.

Airbags only activate if the vehicle overturns in the hybrid plug-in version of the vehicle.

Activation factors

The conditions that lead to the airbag system activating in each situation cannot be generalised. Some factors play an important role, such as the properties of the object the vehicle hits (hard/soft), angle of impact, vehicle speed, etc.

Deceleration trajectory is key for airbag activation.

The control unit analyses the collision trajectory and activates the respective restraint system.

If the deceleration rate is below the predefined reference value in the control unit the airbags will not be triggered, even though the accident may cause extensive damage to the car.

The following airbags are triggered in serious head-on collisions:

- Driver airbag.
- Front passenger front airbag
- Knee airbag for the driver.
- Head airbags.

In the event of serious side collisions, some (or all) of the following airbags can be activated (depending on the severity of the collision):

- Curtain (head) airbag on the side of the accident.
- Front side airbag on the side of the accident.

- Rear side airbag on the side of the accident.
- Central airbag.

In an accident with airbag activation:

- the interior lights switch on (if the interior light switch is in the courtesy light position);
- the hazard warning lights switch on;
- all doors are unlocked;
- the fuel supply to the engine is cut;
- in hybrid vehicles, the high voltage system is switched off;
- an emergency call is started.

Airbag system control lamps**Lights up on the instrument cluster**

Fault in the airbag system and seat belt tensioners. Have the system checked immediately by a specialised workshop.



OFF  Lights up on the roof console





Front passenger front airbag deactivated. Check if the airbag should be kept deactivated.

ON  Lights up on the roof console

Front passenger front airbag activated. The control lamp turns off automatically 60 seconds after the ignition is switched on.

Several warning and control lamps light up for a few seconds when the ignition is switched on, signalling that the function is being verified. They will switch off after a few seconds.

If the airbag and seat belt tensioner system control lamp  remains on or flashes, it indicates a malfunction in the airbag and seat belt tensioner system **»»** . Have the system checked immediately by a specialised workshop.

If the front passenger airbag has been deactivated, the warning lamp **OFF**  remains lit on the roof console to remind you that the airbag is deactivated. If, with the front passenger airbag deactivated, this lamp **does not remain lit** or if it is lit along with the control lamp  on the instrument panel, there is a fault in the airbag system **»»** . If the control lamp is flashing, there is a fault in the disabling of the airbag system **»»** . Have the system checked immediately by a specialised workshop.

WARNING

In the event of a fault in the airbag and seat belt tensioner system, the airbags and seat belts may not trigger correctly, may fail to trigger or may even trigger unexpectedly.

- The vehicle occupants run the risk of sustaining severe or fatal injuries. Have the system checked immediately by a specialised workshop.

- Do not mount a child seat in the front passenger seat or remove the mounted child seat! The front passenger front airbag may deploy during an accident in spite of the fault.

NOTICE

Always pay attention to any lit control lamps and to the corresponding descriptions and instructions to avoid damage to the vehicle or harm to the occupants.

Front airbags

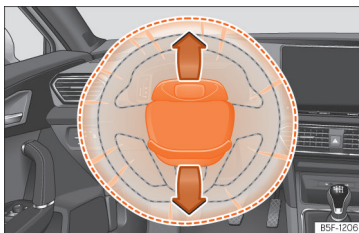


Fig. 29 Driver's airbag in the steering wheel.

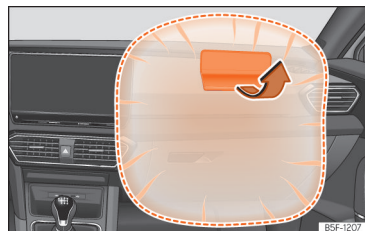



Fig. 30 Front passenger airbag located in dash panel.

The driver's front airbag is housed in the steering wheel and that of the front passenger, on the dash panel. Airbags are identified by the word "AIRBAG".

The airbag covers open and remain attached to the steering wheel and instrument panel when the driver and front passenger airbags are triggered, respectively **»»** **Fig. 29** , **»»** **Fig. 30**.

In conjunction with the seat belts, the front airbag system gives the front occupants additional protection for the head and chest in the event of a severe frontal collision **»»** .

In addition, in certain head-on collisions, the head airbag is triggered on both sides of the vehicle.

Their special design allows the controlled escape of the propellant gas when an occupant puts pressure on the bag. Thus, the head and

chest are protected by the airbag. After the collision, the airbag deflates sufficiently to allow visibility.

WARNING

- The deployment space between the front passengers and the airbags must not in any case be occupied by other passenger, pets and objects.
- The airbags provide protection for just one accident; replace them once they have deployed.
- It is also important not to attach any objects such as cup holders or telephone mountings to the surfaces covering the air-bag units.

Activate and deactivate front passenger front airbag

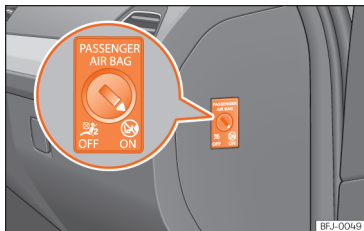


Fig. 31 Switch for activating and deactivating the front passenger airbag.



Fig. 32 On the roof console: passenger airbag deactivation control lamp.

Deactivate the front passenger front airbag only if you have to use a rear-facing child seat in the front passenger seat.

SEAT recommends fitting the child seat in the rear seat to avoid having to deactivate the front passenger airbag.

When the front passenger airbag is **deactivated**, this means that only the front passenger front airbag is deactivated. All the other airbags in the vehicle remain activated.

Deactivate and activate the front passenger front airbag

- Switch the ignition off.
- Open the passenger side door.
- Remove the key shaft from the vehicle key.

- Insert the key blade into the slot provided in the front passenger airbag disconnection switch »» **Fig. 31**. About 3/4 of the key should enter; this is as far as it will go.
- Turn the key gently to change its position to **OFF** (deactivate) or to **ON** (activate). If you have difficulty, ensure that you have inserted the key as far as it will go.
- Close the front passenger door.
- When deactivating the airbag, switch the ignition on and check that the control lamp **OFF** remains lit »» **Fig. 32**.
- When reactivating the airbag, check that when the ignition is switched on, the **OFF** control lamp does not light up and the **ON** lamp lights up for 60 seconds and then turns off.

WARNING

- The driver of the vehicle is responsible for disabling or switching on the airbag.
- Always switch off the ignition before disabling the front passenger airbag! Failure to do so could result in a fault in the airbag deactivation system.
- Never leave the key in the airbag disabling switch as it could get damaged or enable or disable the airbag during driving.
- If for any reason an airbag is deactivated, reactivate it as soon as possible so that it can fulfil its protective function.

Central airbag

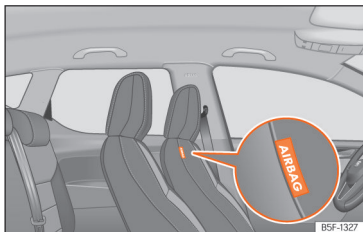


Fig. 33 In the inner padding of the driver's seat backrest: central airbag.

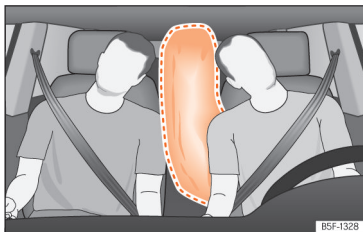


Fig. 34 Fully inflated central airbag (deployment zone).

The central airbag is installed for the front seats and is located in the inner padding of the driver's seat backrest.

The location of the central airbag is indicated by the inscription "AIRBAG" >>> **Fig. 33**.

When triggered, the central airbag fills the marked zone (deployment zone) >>> **Fig. 34**. For this reason, never place or fix objects in this zone >>> **⚠**.

The central airbag triggers in the case of a side collision or if the vehicle overturns, reducing the risk of vehicle occupants suffering injuries.

⚠ WARNING

When triggered, the airbag inflates at high speed in milliseconds.

- Always keep the central airbag deployment zone clear.
- Never attach objects to the central airbag cover or the deployment zone.
- Do not allow other people, animals or objects to get between the occupants of the front seats and the airbag deployment zone. Make sure that all vehicle occupants, including children, follow this rule.
- Never use upholstery or seat covers that have not been explicitly authorised for the seats of the vehicle. Otherwise, the side airbag will not be able to deploy if triggered.

⚠ WARNING

Improper manipulation of the driver and front passenger seats can prevent the central airbag from operating correctly and cause serious injuries.

- Never remove the front seats from the vehicle or modify their components.
- If the backrest side bolsters are subjected to a lot of force, the central airbag may not trigger correctly, it may not trigger at all or it may trigger unexpectedly.
- Have a specialised repair shop immediately repair any damage to the original seat upholstery or seams in the area of the central airbag module.

Side airbags



Fig. 35 Side airbag in driver's seat.

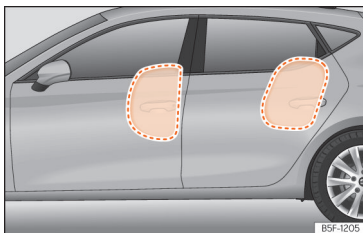



Fig. 36 Illustration of completely inflated side airbag on left side of vehicle.

The side airbags are located in the backrests of the front seats and in the sides of the rear seat, depending on the vehicle's configuration

»» Fig. 35, »» Fig. 36.

Its location is marked with the word "AIRBAG" on the upper part of the back of the seats or on the lower coverings with the word AIRBAG in relief.

In conjunction with the seat belts, the side airbag system provides additional protection for the upper body in the event of a severe side collision »» .

In a side collision, the side airbags reduce the risk of injury to passengers to the areas of the body facing the impact. In addition to their normal protection, the seat belts also hold the passengers in the event of a side collision; this is how these airbags provide maximum protection.

WARNING

- If you do not wear a seat belt, if you lean forward, or are not seated correctly while the vehicle is in motion, you are at a greater risk of injury if the side airbag system is triggered in an accident.
- In order for the side airbags to provide their maximum protection, the prescribed sitting position must always be maintained with seat belts fastened while travelling.
- In a side-on collision the side airbags will not work if the sensors do not correctly measure the pressure increase on the interior of the doors, due to air escaping through the areas with holes or openings in the door panel.
- Never drive if the interior door panels have been removed or if the panels have not been correctly fitted.
- Occupants of the outer seats must never carry any objects or pets in the deployment space between them and the airbags, or allow children or other passengers to travel in this position. It is also important not to attach any accessories (such as cup holders) to the doors. This would impair the protection offered by the side airbags.
- Ensure that children are correctly seated in their seats and that their heads are not in the deployment zone of the side airbags
»» Fig. 36, as deploying airbags could hit them and cause serious injury.

- The built-in coat hooks should be used only for lightweight clothing. Do not leave any heavy or sharp-edged objects in the pockets.
- Great forces, such as hard blows or kicks, must not be exerted upon the backrest bolster because the system may be damaged. In this case, the side airbags would not be triggered.
- Under no circumstances should protective covers be fitted over seats with side airbags unless the covers have been approved for use in your vehicle. Because the airbag deploys from the side of the backrest, the use of conventional seat covers would obstruct the side airbag, seriously reducing the airbag's effectiveness.
- Any damage to the original seat upholstery or around the seams of the side airbag units must be repaired immediately by a specialised workshop.
- The airbags provide protection for just one accident; replace them once they have deployed.
- Any work on the side airbag system or removal and installation of the airbag components for other repairs (such as removal of the front seat) should only be performed by a specialised workshop. Otherwise, faults may occur during the airbag system operation.

Head-protection airbags

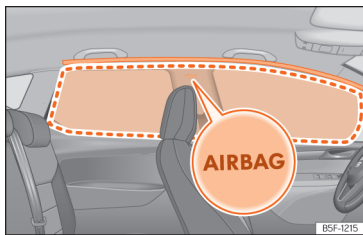


Fig. 37 Location and deployment area of the head-protection airbag.

Head-protection airbags are on both sides of the passenger compartment, above the doors »» **Fig. 37** and their location is indicated with the word "AIRBAG".

In combination with the seat belts, the Side Curtain Protection® airbags provide additional protection for the upper part of the body of vehicle occupants in the event of serious side collisions or the vehicle overturning »» **△**.

The framed area is covered by the head-protection airbag when it is deployed (deployment area) »» **Fig. 37**. Therefore, objects should never be placed or mounted in this area »» **△**.

In the event of a side collision the curtain airbag is triggered on the impact side of the vehicle.

The head-protection airbags reduce the risk of injury to passengers in the front and rear side seats facing the impact.

△ WARNING

- In order for the head-protection airbags to provide their maximum protection, the prescribed sitting position must always be maintained with seat belts fastened while travelling.
- For safety reasons, the curtain airbag must be disabled in those vehicles fitted with a screen dividing the interior of the vehicle. See your technical service to make this adjustment.
- There must be no other persons, animals or objects between the occupants of the outer seats and the deployment space of the head-protection airbags so that the head-protection airbag can deploy completely without restriction and provide the greatest possible protection. Therefore, sun blinds which have not been expressly approved for use in your vehicle may not be attached to the side windows.
- Ensure that children are correctly seated in their seats and that their heads are not in the deployment zone of the head airbags »» **Fig. 37**, as deploying airbags could hit them and cause serious injury.

- The built-in coat hooks should be used only for lightweight clothing. Do not leave any heavy or sharp-edged objects in the pockets. Please, do not hang the clothes on coat hangers.
- The airbags provide protection for just one accident; replace them once they have deployed.
- Any work on the head-protection airbag system or removal and installation of the airbag components for other repairs (such as removal of the roof lining) should only be performed by a specialised workshop. Otherwise, faults may occur during the airbag system operation.
- The side and head airbags are managed through sensors located in the interior of the front doors. To ensure the correct operation of the side and curtain airbags neither the doors nor the door panels should be modified in any way (e.g. fitting loudspeakers). If the front door is damaged, the airbag system may not work correctly. All work carried out on the front door must be done in a specialised workshop.

Knee airbag

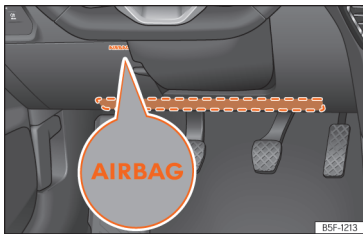


Fig. 38 On the driver side: location of airbag for knees.

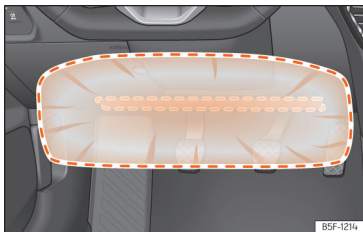


Fig. 39 On the driver side: action radius of airbag for knees.

The knee airbag is located on the driver side below the dash panel »» **Fig. 38**. Airbags are identified by the word "AIRBAG".

The framed area (deployment area) »» **Fig. 39** is covered by the knee airbag when it is deployed. Objects should never be placed or mounted in this area.

⚠ WARNING

- The knee airbag is deployed in front of the driver's knees. Always keep the deployment areas of the knee airbags free.
- Never not fix objects to the cover or in the deployment area of the knee airbag.
- Adjust the driver's seat so that there is a distance of at least 10 cm [4 inches] between your knees and the location of this airbag. If your physical constitution prevents you from meeting these requirements, make sure you contact a specialised workshop.

Transporting children safely

Introduction

For safety reasons, as we have learned from accident statistics, we recommend that children under 12 years of age travel in the rear seats. Depending on their age, height and weight, children travelling in rear seats must use a child seat or a seat belt. For safety reasons, the child seat should be installed in the rear seat, behind the front passenger seat or in the centre back seat.

The laws of physics involved and the forces acting in a collision apply also to children »» **page 46**. But unlike adults, children do not have fully developed muscle and bone structures. This means that children are subject to a greater risk of injury.

To reduce the risk of injuries, children must always use special child restraint systems when travelling in the vehicle.

We recommend the use of child safety products from the Original Accessories Programme, which includes systems for all ages made by "Peke" (not for all countries) [see www.seat.com].

These systems have been especially designed and approved, complying with the ECE-R44. regulation.

SEAT recommends securing the child seats shown on the website as described below:

- Child seats in the opposite direction of travel (group 0+): ISOFIX and support leg (ROMER BABY SAFE 3 i-SIZE + ISOFIX BASE / PEKE GO i-SIZE + i-SIZE BASE).
- Child seats in the direction of travel (group 1): ISOFIX (PEKE G1 TRIFIX i-SIZE).
- Forward-facing child seats (group 2): seatbelt and ISOFIX (ROMER BRITAX KIDFIX i-SIZE. In addition, the child seat's attachment point for the "SecureGuard" lap belt must be used, and the "SICT" side impact protection system located at the rear of the child seat must be adjusted).

ted. Adjust only the "SICT" closest to the door. Please follow the child seat manufacturer's usage instructions).

- Child seats directed towards the front of the vehicle (group 3): safety belt (TAKATA MAXI).

Follow the manufacturer's instructions and observe any statutory requirements when installing and using child seats. Always read and note »» page 61.

We recommend you always carry the manufacturer's Child Seat Instruction Manual together with the on-board documentation.

Child seats group classification

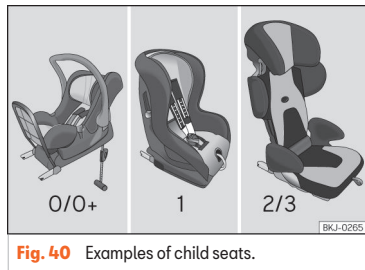


Fig. 40 Examples of child seats.

Use only child seats that are officially approved and suitable for the child.

These seats are subject to the ECE-R44 or ECE-R129 standards. ECE-R stands for: Economic Commission for Europe Regulation.

Child seats by weight group

The child seats are grouped into 5 categories:

Age group	Weight of the child
Group 0	Up to 10 kg
Group 0+	Up to 13 kg
Group 1	From 9 to 18 kg
Group 2	From 15 to 25 kg
Group 3	From 22 to 36 kg

Child seats that have been tested and approved under the ECE R44 or ECE-R129 standards bear the ECE-R44 or ECE-R129 test marks on the seat (the letter E in a circle with the test number below it).

Follow the manufacturer's instructions and observe any statutory requirements when installing and using child seats.

We recommend you to always include the manufacturer's Child Seat Instruction Manual together with the on-board documentation.

SEAT recommends you use child seats from the **Original Accessories Catalogue**. These child seats have been designed and tested for use in our vehicles. You can find the right child seat for your model and age group at our dealers.

Child seats by approval category

Child seats may have the approval category of universal, semi-universal, vehicle specific (all according to the ECE-R44 standard) or i-Size (according to the ECE-R129 standard).

- **Universal:** child seats with universal approval can be installed in all vehicles. There is no need to consult any list of models. In the case of universal approval for ISOFIX, the child seat is additionally provided with a Top Tether belt.
- **Semi-universal:** semi-universal approval, in addition to the standard requirements of universal approval, requires safety devices to lock the child seat, which require additional testing. Child seats with semi-universal approval include a list of vehicle models for which they can be installed.
- **Vehicle-specific:** vehicle-specific approval requires a dynamic test of the child seat for each vehicle model separately. Child seats with vehicle-specific approval also include a list of vehicle models for which they can be installed.
- **i-Size:** child seats with i-Size approval must meet the requirements prescribed in the ECE-R129 standard in relation to installation and safety. Child seat manufacturers can tell you which seats have i-Size approval for this vehicle.

Fitting and using child seats



Fig. 41 Airbag sticker: on the passenger side sunshade blind.

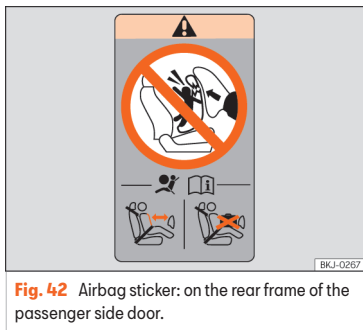


Fig. 42 Airbag sticker: on the rear frame of the passenger side door.

Warnings about fitting a child seat

Take the following general warnings into account if you are going to fit a child seat. They are valid for all child seats regardless of their attachment system.

- Please read and follow the child seat manufacturer's operating instructions.
- The child seat should preferably be fitted to the rear seat behind the front passenger seat so that the child can exit the vehicle on the pavement side.
- Set the height of the seat belt such that it adapts to the child seat naturally, without twisting. The lowest position of the seat belt height regulator must be used with rear-facing child seats.
- To correctly use a child seat in the back, the front backrest must be adjusted so that there is no contact with the child seat in the back in the case that it goes opposite to the direction of the car. In the case of front facing restraint systems, the front backrest must be adjusted so that there is no contact with the child's feet.
- For a correct assembly of the child's seat on the rear seats, adjust or dismount the headrest, in order to prevent contact with the seat.
- If a semi-universal type chair is to be installed, in which the method of attachment to the car is through the seat belt and support bracket, it should never be installed in the central rear

seat as the ground clearance is lower than in other places and the support bracket will not allow the seat to remain sufficiently stable.

- When fitting a child seat on the front passenger seat, the seat must be moved backwards as far as possible and placed in the highest position. The backrest must also be put in a vertical position¹⁾.

Important information about the front passenger front airbag

A sticker with important information about the passenger airbag is located on the passenger's sunshade blind and/or on the passenger side door frame »» Fig. 41.

Read and always observe the safety information included in the following chapters:

- Safety distance with respect to the passenger airbag »» page 51.
- Objects between the passenger and the passenger side airbag »» **△ in Front airbags on page 55.**

The passenger side front airbag, when enabled, is a serious risk for a child that is facing backward since the airbag can strike the seat with such force that it can cause serious or fatal injuries. Children up to 12 years old should always travel on the rear seat.

¹⁾ Compliance with current national legislation and the manufacturer's instructions is required when using or installing child seats.

Therefore we strongly recommend you to transport children on the rear seats. This is the safest location in the vehicle. Alternatively, the front passenger airbag can be disabled with a key-operated switch »» page 55. When transporting children, use a child seat suitable for the age and size of each child »» page 60.

WARNING

- If a child seat is secured to the front passenger seat, the risk to the child of sustaining critical or fatal injuries in the event of an accident increases.
- An inflating front passenger airbag can strike the rear-facing child seat and project it with great force against the door, the roof or the backrest.
- Never install a child seat facing backwards on the front passenger seat unless the front passenger front airbag has been disabled. Risk of potentially fatal injuries to the child! However, if necessary, the front passenger front airbag must be deactivated »» page 55. If the passenger seat has a height adjustment option, move it to the highest, most upright position. If you have a fixed seat, do not install any child restraint system in this location.
- For those vehicles that do not include a key lock switch to deactivate the airbag, the vehicle must be taken to a technical service. Do not forget to reconnect the airbag when an adult wants to sit in the front passenger seat.

- **Never allow a child to be transported in a vehicle without being properly secured, or to stand up or kneel on a seat while traveling. In an accident, the child could be flung through the vehicle, causing possibly fatal injuries to themselves and to the other vehicle occupants.**
- **Never leave a child alone in the child seat or in the vehicle.**
- **Children who are less than 1.50 m tall must not wear a normal seat belt without a child seat, as this could cause injuries to the abdominal and neck areas during a sudden braking manoeuvre or in an accident.**
- **When a child seat is mounted in the rear seats, the door child-proof lock should be activated »» page 99.**

Attachment systems

Depending on the country, different attachment systems are used for safely installing child seats.

Attachment systems overview


- **ISOFIX:** ISOFIX is a standardised attachment system allowing quick and safe attachment of child seats in the vehicle. ISOFIX attachment establishes a rigid connection between the child seat and the car body.

The child seat has two rigid attachment clips, called connectors. These connectors are fitted into the ISOFIX attachment rings found be-

tween the seat cushion and the backrest of the vehicle's back seat (on the sides). ISOFIX attachment systems are used mainly in Europe »» page 63. If necessary, ISOFIX attachment may have to be supplemented with a Top Tether belt or a support bracket.

- **Automatic three-point seat belt.** Whenever possible, it is preferable to attach the child seats with the ISOFIX system rather than attaching them with an automatic three-point seat belt »» page 67.

Additional attachment:

- **Top Tether:** The Top Tether belt is guided over the back of the rear seat and attached to an anchor point with a hook. Anchor points are located at the back of the rear seat backrest on the luggage compartment side »» page 66. The rings for retaining the Top Tether belt are marked with an anchor symbol.
- **Support bracket:** some child seats rest on the floor of the vehicle with a support bracket. The support bracket prevents the child seat from tipping forward in the event of impact. Child seats fitted with a support bracket should only be used in the passenger seat and side rear seats »» . For the assembly of this type of seat you should also consult the list of approved vehicles for this assembly, available in the instructions for child restraint systems.

Recommended systems for attaching child seats

SEAT recommends attaching child seats as follows:

- **Baby carriers or child seats in the opposite direction of travel:** ISOFIX and support bracket or i-Size.
- **Child seats in the direction of travel:** ISOFIX and Top Tether.

WARNING

Incorrect use of the support bracket can cause serious or fatal injury.

- Make sure the support bracket is correctly and safely installed.
- When the base of the child seat is supporting the child's weight, the support foot should not hang in the air or be supplemented with objects. In addition, make sure that the base of the child seat is always supported by the surface of the vehicle's seat. The

support leg of the child seat should not raise the base of the child seat off the surface of the vehicle's seat.

Securing the child seat with the ISO-FIX or i-Size system

The marking of ISOFIX or i-Size anchor points depends on the equipment and the country in question.

See the following tables to understand the compatibility of the ISOFIX/i-Size systems in the vehicle:

Vehicle ISOFIX/i-Size positions

Weight group	Child seat orientation	Size class / ISOFIX class	Front passenger seat		Rear side seat	Rear central seat
			airbag enabled	airbag disabled		
Baby carrier	--	F / L1	X	X	X	X
	--	G / L1	X	X	X	X
Group 0: up to 10 kg	Rear facing	E / R1	X	IL	IL	X
Group 0+: up to 13 kg	Rear facing	E / R1	X	IL	IL	X
		D / R2	X	IL	IL	X
		C / R3	X	IL	IL	X
Group I: 9 to 18 kg	Rear facing	D / R2	X	IL	IL	X
		C / R3	X	IL	IL	X
	Forward-facing	B / F2	IL, IUF	X	IL, IUF	X
		B1 / F2X	IL, IUF	X	IL, IUF	X
		A / F3	IL, IUF	X	IL, IUF	X
Group II: 15 to 25 kg ^{a)}	Forward-facing	-- / --	IL	X	IL	X
Group III: 22 to 36 kg ^{a)}	Forward-facing	-- / --	IL	X	IL	X
i-Size child seat	Rear facing	-- / R2	X	IUF	IUF	X
	Forward-facing	-- / B2, F2X	IUF	X	IUF	X
Booster	Forward-facing	-- / B2, B3	IB	X	IB	X

^{a)} Installation in front seats requires reclining the backrest.

- **Size class:** The indication of class according to size corresponds to the authorised bodyweight for the child seat. In child seats with universal or semi-universal approval, the class according to size is indicated on the ECE approval label. The indication of class according to size is stated on the corresponding child seat.
- **IUF:** Suitable for forward-facing ISOFIX / i-Size "universal" child restraint systems approved for use in this weight group.

- **IL:** It is suitable for certain ISOFIX child restraint systems that can be for the specific vehicle, restricted or semi-universal categories. Take the child seat manufacturer's vehicle list into account.
- **IB:** Seat suitable for installing an ISOFIX forward-facing group 2/3 booster seat as well as an i-size forward-facing child seat for children with a height of 100 to 150 cm.
- **X:** Position not suitable for ISOFIX or i-Size child restraint systems in this weight group or size class.

Securing the child seat with the ISOFIX or i-Size system

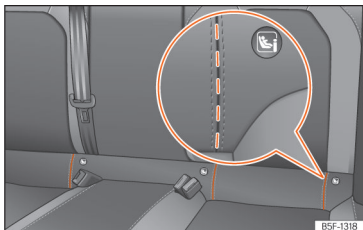


Fig. 43 Rear seat: die cut slots to access the ISOFIX / iSize securing rings.



Fig. 44 Front passenger seat: location of the i-Size fastening rings.

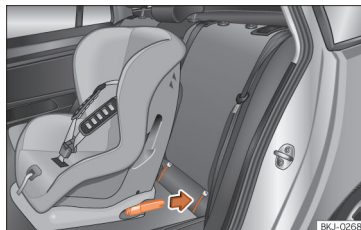


Fig. 45 Rear seats: fitting a child seat with the ISOFIX system.

You must follow the child seat manufacturer's instructions.

The location of the ISOFIX or i-Size anchor points is indicated by a symbol »» Fig. 43 , »» Fig. 44. In some vehicles, the rings are secured to the seat frame and, in others, they are secured to the rear floor.

- First open the cut-out section behind the marked grooves to access the retaining rings »» Fig. 43.
- Press the child seat onto the ISOFIX or iSize retaining rings until it is heard to engage securely »» Fig. 45. If the child seat is equipped with Top Tether anchor points, secure it to the correspondent ring »» page 66. Follow the child seat manufacturer's instructions.
- Pull on both sides of the child seat to ensure that it is properly anchored.

Child seats with the ISOFIX or i-Size and Top Tether attachment system can be purchased from technical services.

WARNING

The securing rings are designed only for use with ISOFIX or i-Size and Top Tether system child seats.

- Never secure other child seats that do not have ISOFIX, i-Size or Top Tether systems, or safety belts or any other objects to the securing rings – as this can result in potentially fatal injuries to the child.
- Ensure that the child seat is correctly secured to the ISOFIX or i-Size rings and the Top Tether.

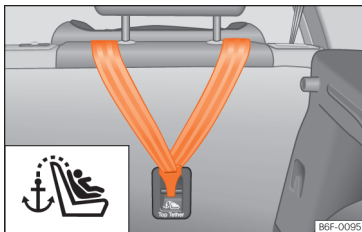
Top Tether securing belts

Fig. 46 Rear part of the rear seats: securing rings for the Top Tether belt.

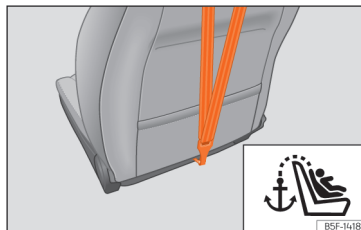



Fig. 47 Rear of front passenger seat backrest: Top Tether belt anchor.

Child seats with a Top Tether system are fitted with an additional belt for fastening to an anchor point in the vehicle. This anchor point is located on the rear of the rear seat backrest and of the front passenger seat backrest (identified with the symbol ) and provides better retention >>> Fig. 46, >>> Fig. 47.

The objective of this system is to reduce forward movements of the child seat in a head-on collision, to reduce the risk of injuries that may be caused to the child's head by impacting against any element of the inside of the vehicle.

Use of Top Tether on rearward-facing child restraints

Currently, there are very few rearward-facing child restraints with Top Tether. The car seat manufacturer's instructions for proper installation of the Top Tether should be read carefully and followed.

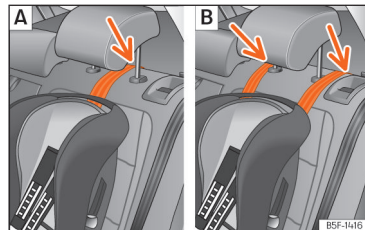
Locking the tether belt

Fig. 48 Rear seats: adjustment and assembly according to the Top Tether belt.

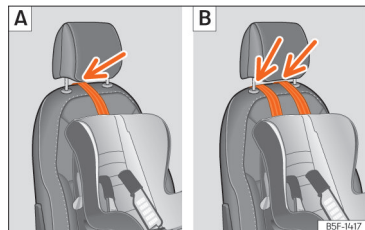


Fig. 49 Front passenger seat: adjustment and assembly according to the Top Tether belt.

- Deploy the Top Tether belt according to the child seat manufacturer's instructions.
- Position the belt under the headrest (according to the instructions of the seat itself, lift or remove the headrest if necessary) >>> **Fig. 48**, >>> **Fig. 49**.
- Slide the belt and secure it properly with the anchor on the rear seat backrest >>> **Fig. 46**, >>> **Fig. 47**.
- Tighten the belt securely according to the manufacturer's instructions.

Release the tether belt

- Slacken the belt according to the manufacturer's instructions.
- Press the lock and release it from the anchor bracket.

WARNING

Installing safety seats incorrectly will increase the risk of injury in the event of a collision.

- Never attach the tether belt to a fastening hook in the luggage compartment.
- Never attach or secure luggage or other items to the lower anchor points (ISOFIX) or Top Tether anchor points.

WARNING

Child restraint anchors are designed to support the loads of properly adjusted child restraint systems. Under no circumstances should they be used to attach adult seat belts, harnesses or other items or equipment to the vehicle.

Fitting a child seat using the seat belt

If you want to fit a universal approval category (U) child seat in your vehicle, you must check that the seat is approved for your vehicle.

You will find any necessary information on the child seat's orange ECE approval label.

The following table shows the different fitting options.

Weight group	Front passenger seat ^{a)}		Rear side seat	Rear central seat ^{b)}
	Airbag enabled ^{c)}	Airbag deactivated ^{c)}		
Group 0 up to 10 kg	X	U	U	U
Group 0+ up to 13 kg	X	U	U	U
Group I 9 to 18 kg	Rear-facing	X	U	U
	Forward-facing	U	X	U
Group II 15 to 25 kg	U	X	U	U
Group III 22 to 36 kg	U	X	U	U

X: Not compatible for the installation of seats install chairs in this configuration.

U: Suitable for universal restraint systems for use in this weight group.

^{a)} Compliance with current national legislation and the manufacturer's instructions is required when using or installing child seats.

^{b)} For semi-universal chairs where the securing system is the car safety belt and the support bracket, do not use them in the centre rear seat or the third row.

^{c)} Seats **without** height adjustment should be placed in their rearmost position. Seats **with** height adjustment should be placed in their rearmost and highest position.

Fitting a child seat using the seat belt

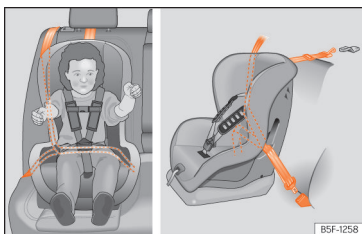


Fig. 50 On rear seats: installing a child seat.

- Put the seat belt in place and pass it through the child seat according to the instructions of the child seat manufacturer.
- Make sure that the seat belt is not twisted.
- Insert the latch plate into the seat's buckle until you hear the engagement click.

WARNING

When travelling, children must be secured in the vehicle with a restraint system suitable for age, weight and size.

- Always read and observe information and warnings concerning the use of child seats >>> page 61.

In case of emergency


Hazard warning lights





Fig. 51 Dashboard: switch for hazard warning lights.

The hazard warning lights are used to draw the attention of other road users to your vehicle in emergencies.

If your vehicle is stationary:

1. Park the vehicle at a safe distance from road traffic.
2. Press the button to switch on the hazard warning lights **»»** .
3. Apply the electronic parking brake.
4. Stop the engine.
5. Engage 1st gear in vehicles with a manual gearbox, or press the parking lock button **P** in vehicles with automatic transmission.

6. Follow the legal provisions of each country (reflective vest, warning triangles, light beacon, etc.).
7. Always carry the key with you when leaving the vehicle.

All turn signals flash simultaneously when the hazard warning lights are switched on. The two turn signal turn signal lamps  and the turn signal lamp in the switch  will flash at the same time. The simultaneous hazard warning lights also work when the ignition is switched off.

While the hazard warning lights are on, you can signal a direction or lane change, e.g. during towing, by operating the turn signal lever. The hazard warning lights remain switched off during this time.

Emergency braking warning

If the vehicle brakes suddenly and continuously at a speed of more than 80 km/h (50 mph), the brake light flashes several times per second to warn the vehicles driving behind. If you continue braking, the hazard warning lights will come on automatically when the vehicle comes to a standstill. They switch off automatically when the vehicle starts to move again.

WARNING

- The risk of an accident increases if your vehicle breaks down. Always use the hazard warning lights and a warning triangle (or light beacon, depending on the country) to draw the attention of other road users to your stationary vehicle.
- Never leave anybody inside the vehicle, particularly children or anybody who may need help. This is especially important when the doors are locked. Individuals locked in the vehicle can be exposed to very high or very low temperatures.
- Due to the high temperatures that the catalytic converter can reach, never park in an area where the catalytic converter could come into contact with highly inflammable materials, for example dry grass or spilt petrol. This could start a fire.

Note

- The 12-volt vehicle battery will run down if the hazard warning lights are left on for a long time (even if the ignition is switched off).
- The use of the hazard warning lights described here is subject to the relevant statutory requirements.

Behaviour in the event of an accident or fire

Actions to take in the event of a fire or accident

For your own safety and that of other passengers, the following points should be observed in the order given >>> ⚠:

- Switch off the engine.
- If possible, switch on the hazard warning lights >>> page 69.
- Follow the legal provisions of each country (reflective vest, warning triangles, light beacon, etc.).
- If necessary, get any people out of the hazard area and apply first aid.
- Notify the emergency services.
- Wait at a safe distance from the scene of the accident for the emergency services to arrive.
- In case of fire, do not attempt to extinguish the fire yourself or remain near the vehicle.

⚠ WARNING

For your own safety, do not ignore this important check list, otherwise accidents and serious injuries could occur.

- Always complete the operations on the check list and always bear in mind the general safety measures.

⚠ WARNING

In the event of fire, an explosion may occur and substances harmful to health may be released, which can cause serious injury.

- Never stay near the burning vehicle.

Emergency call service



Fig. 52 On the roof console: controls for voice services.



Fig. 53 Emergency call button.

Depending on the equipment, an emergency call system may be located on the roof console.

The following voice services can be run by pressing the buttons **i**, **☎** and **SOS** >>> **Fig. 52**:

- information call
- assistance call
- emergency call service.

A built-in control unit establishes the connection.

When a voice service is activated, a connection is established with a phone line.


Control lamp

There is a control lamp on the control >>> **Fig. 52** (arrow). It shows the following statuses:

- **Off:** the eCall service is not available.
- **Flashes in red, approx. 20 seconds after swing on the ignition:** the eCall service is deactivated.
- **Lights up red:** system failure. The eCall service is available with certain restrictions. SEAT suggests going to a specialised workshop.
- **Lights up green:** the eCall service is available. The system works correctly.
- **Flashes green:** There is an ongoing voice connection.

Emergency call service¹⁾

The automatic emergency call is only activated if the ignition is switched on.


If the airbags or, if applicable, the seatbelt tensioners are triggered, a connection is automatically established with the emergency coordination centre. The automatic emergency call **cannot** be interrupted by pressing the button  **>>> Fig. 53 ①**.

If the emergency coordination centre's questions are not answered, the corresponding assistance measures are implemented.

The person on the other end of the line uses the language of the country in which you are driving.

¹⁾ Only available in certain countries.

Starting an emergency call manually

- Briefly press the button cover  and open the cover **>>> Fig. 53**.
 - Press and hold the emergency call button for a few seconds **>>> Fig. 53 ①**. The emergency call is activated and a voice connection is established with the emergency coordination centre.
- If you press the emergency call button inadvertently, hang up the call immediately:
- Press the emergency call button again until the control light stays green.

Integrated battery

The integrated battery ensures that the emergency call system (eCall) remains available for some time even if the 12-volt battery has been disconnected or has failed.

If the integrated battery discharges or is defective, a message stating this is displayed on the instrument cluster display. Go to a specialised workshop and ask for the battery to be replaced.

EDR data transmission >>> page 372

When an emergency call is made, the legally required data is transmitted to the emergency coordination centre so that the necessary assistance measures can be determined.

Vehicle location data is continuously overwritten. This means that the vehicle is not subject to permanent monitoring.

The data related to the emergency call is only processed to ensure the correct operation of the emergency call system (eCall). The system will automatically delete the data related to the call a few hours after the call is activated.

The sent data includes:

- The vehicle's current position at the time the emergency call is activated.
- Vehicle identification number (VIN)
- Type of vehicle and type of drive.
- Type of activation (automatic or manual).
- Type of call.
- Direction in which the vehicle was travelling at the time the emergency call was activated.
- Moment of the collision.
- Estimated number of vehicle occupants.

Situations in which the emergency call service may be restricted

- The emergency call is made from an area with weak or no mobile and GPS signal, as well as e.g. tunnels, between very tall buildings, garages, underground walkways, mountains and valleys.

- The components of the vehicle required for the emergency phone call are damaged or do not get enough power.
- In some countries, the emergency call service may not be available and depending on the location of the vehicle, the control lamp LEDs, and even the operation of the different types of calls, could have a specific behaviour.

📞 Assistance call¹⁾

With the breakdown call you can directly request specialised help in the event of a breakdown.

Parallel to the voice call, some vehicle data is transmitted, e.g. your current location.

📞 Information call¹⁾

With a information call, a call is placed to the customer care service of SEAT. S.A.

Note

- **Breakdown service and information calls can incur an additional cost on your telephone bill.**
- **The operation of the eCall system, which is required by law, may be limited if an infotainment system is retrofitted.**

¹⁾ Only available in certain countries.

High-voltage battery

Safety instructions

Introduction

Valid for: hybrid vehicles

WARNING

The vehicle's high-voltage network and the high-voltage battery are hazardous and can cause burns and other injuries, including fatal electric shocks.

- It should always be assumed that the high-voltage battery is fully charged and that all of its components are live. This may also be the case when the ignition is switched off.
- Never touch the high-voltage cables, the high-voltage battery or its poles, or allow them to come into contact with jewellery or other metal objects, especially if the high-voltage cables, the high-voltage battery or its poles are damaged.
- Never take it upon yourself to perform any type of work on the high-voltage network, on the high-voltage cables or the high-voltage battery.
- Never open or perform maintenance or repairs on components or parts of the high voltage network, or disconnect them from this network.

- Never damage, modify or remove the orange high voltage cables or disconnect them from the high voltage network.
- Never open, modify or remove the cover from the high-voltage battery.
- Work on the high-voltage system, as well as on any systems that may be indirectly influenced by it, should only be carried out by specialized personnel with the corresponding qualifications and training.
- Work in the immediate vicinity of high-voltage cables and high-voltage components with tools that are sharp, give off shavings or that have heat sources, such as hot air, thermal bonding or welding work, may only be performed after disconnecting the voltage. The high voltage should only be disconnected by specialized personnel with the corresponding qualifications and training.
- All SEAT guidelines and standards must be followed when performing any work on the high-voltage system and the high-voltage battery.
- The gases that are emitted or leaked from the high-voltage battery may be toxic or flammable.
- Damage to the vehicle or high voltage battery could cause an immediate or delayed leak of toxic gases. The emitted gases could also cause a fire. Do not inhale the gases.

- Never touch the liquids that spill from the high voltage battery and do not touch the emitted gases, particularly if the battery is damaged.
- In the event of a fire, leave the danger area and call the fire department.
- Always inform the fire fighters and the emergency service that the vehicle is fitted with a high-voltage battery.

WARNING

If works are performed on the high-voltage system and on the high-voltage components in an inappropriate manner, this may lead to faults in the operation, accidents and injuries.

- Work on the high-voltage system must only be performed by authorized specialized services with the corresponding permit.

NOTICE

If the vehicle suffers an accident or collision with an obstacle, the high-voltage battery must be checked by specialized personnel with the corresponding qualifications and training.

NOTICE

If the 12-volt vehicle battery has been disconnected, discharged or replaced, there is a chance that the combustion engine may not initially turn off automatically after moving off. If this situation lasts for several days, contact a qualified specialized workshop. SEAT recommends visiting a SEAT partner for this.

High voltage warning lettering

Valid for: hybrid vehicles

Warning lettering on the vehicle

The following parts of the vehicle can be identified with the depicted warning lettering >>> Fig. 54, >>> Fig. 55, >>> Fig. 56, >>> Fig. 57:

- Covers and lids behind which live high-voltage components are located.
- All the high-voltage components, including the high-voltage battery.
- Under the front bonnet.



Fig. 54 Warning lettering.

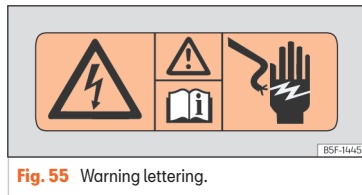


Fig. 55 Warning lettering.

The warning lettering >>> Fig. 54 and >>> Fig. 55 indicate high electrical voltage.



Fig. 56 Warning lettering.

The components of the high voltage system can become very hot and should not be touched >>> Fig. 56.

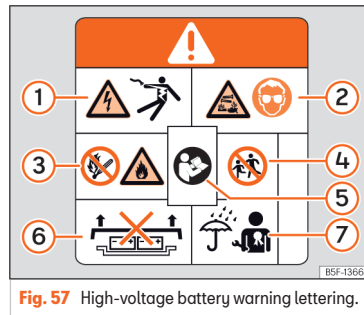


Fig. 57 High-voltage battery warning lettering.

>>> Fig. 57

- ① High voltage can cause serious injury or even death. Never touch the battery poles with bare fingers, tools, jewellery or other metal objects.
- ② The high-voltage battery contains hazardous liquid and solid substances. Emitted gases can cause severe burns and blindness. Suitable eye protection and protective clothing must always be worn when working on the high voltage battery to prevent battery fluid coming into contact with the skin and eyes. If the battery fluid comes into contact with the skin or eyes, the affected areas should be rinsed with clean running water for at least 15 minutes, and then a doctor should be consulted immediately.

- 3 The high-voltage battery may burn. The high-voltage battery should never be exposed to fire, sparks or naked flame. The high voltage battery must always be handled with care to avoid damage and fluid leakages.
- 4 The high-voltage battery should always be kept out of the reach of children.
- 5 You will find further information and warnings in the usage instructions and workshop documentation.
- 6 Incorrect handling of the high-voltage battery can cause serious injuries or death. Never disassemble the high voltage battery or remove its cover.
- 7 Maintenance work on the high-voltage battery must only be performed by specialized personnel with the corresponding qualifications and training. Never modify the high-voltage battery. When the high-voltage battery is open, ensure it does not come into contact with water or other liquids. Liquids may cause short circuits, electrical shocks and burns.

Conservation of the high-voltage battery

Conservation instructions

Valid for: hybrid vehicles

Reliability and capacity of the high-voltage battery

In principle, lithium ion batteries are subject to ageing and wear and tear throughout their useful life due to their physical and chemical characteristics. Correct handling of the high-voltage battery makes an essential contribution to keeping it in a reliable state in the long term and to achieving high battery capacity and range. Therefore, it is extremely important to respect the following conservation instructions for the high voltage battery. These maintenance instructions are essential for maintaining the vehicle's value over time.

Please also observe the applicable SEAT warranty conditions for the high-voltage battery.

Conservation instructions

SEAT recommends the following conservation instructions:

- If possible, charge the high-voltage battery when a low charge level is displayed on the instrument cluster, or when the electric range is low »» page 21.
- It is advisable to not charging the high-voltage battery when only a short trip has been made in full electric mode.

- As much as possible avoid fully discharging the high-voltage battery, such as by leaving the vehicle parked for a prolonged time with a low load level. The charge level must not drop below 20 % for long periods of time »» ⓘ.
- When the high-voltage battery has been charged to 100 %, start driving immediately if possible.

Vehicle parking times

- If there is a frost, do not park the vehicle for several hours with a charge level of lower than 40 % »» ⓘ.
- If you plan to leave your vehicle stationary for prolonged periods of time, park with a charge level of at least 30 %. This situation occurs, for example, when you leave your vehicle at the airport before a trip.
- Do not expose the vehicle to outside temperatures below -30 °C or above 60 °C for more than 24 hours.
- To improve comfort and performance, make sparse use of the stationary air conditioning (depending on the equipment), particularly in temperatures lower than -15 °C »» page 144.

ⓘ NOTICE

The high-voltage battery must not be used as a stationary power supply. This can cause irreversible damage to the high-voltage battery.

NOTICE

If the vehicle is parked for a long time with the high-voltage battery discharged, it may no longer be possible to charge the battery or start the vehicle. Irreversible damage could be caused to the high voltage battery in the long term.

- Charge the high-voltage battery at regular intervals.

Charging the high-voltage battery

Introduction

Valid for: hybrid vehicles

Check that the driving mode is deactivated and that the charging cable and infrastructure are in perfect condition.


Types of charging

The following charging types are possible for the vehicle:

- *Charging with alternating current (AC) at a public or home charging station (Mode 3 charging) »» page 77:*

Charges at high power. The maximum achievable charging power depends on the charging station and charging cable that is used and the performance of the vehicle's charger.

- *Charging with alternating current (AC) at a household socket (Mode 2 charging) »» page 77:*

The electrical installation of the house must have been checked and be in perfect working order »» . You must plan for a longer charging time, e.g. overnight.

- *Charging with direct current (DC) at a fast charging station (Mode 4 charging):*

Direct current charging **is not compatible** with this vehicle.

Protection against current leakage

The vehicle is fitted with a direct current (DC) leakage protection device. This prevents any current leakage that may occur during charging from reaching the house's electrically installation through the charging cable.

WARNING

If the battery is charged in an inappropriate manner, if no consideration is given to the appropriate safety measures or the high-voltage battery is used in an inadequate manner, this could lead to short circuits, electrical shocks, explosions, fires, burns and serious injuries, even death.

- **Always respect the stipulated order of the operations to avoid the risk of suffering an electric shock or serious injuries due to the residual energy in the charging accumulator.**

- **Please observe the safety and handling instructions of the charging cable supplied with the vehicle »» page 82.**

- **When charging, only use power sockets that are appropriately fitted, have been checked and are not damaged, as well as electrical installations that are in perfect working order. Duly qualified technicians should check the power sockets and the electrical installation on a regular basis.**

- **Never charge the vehicle in places where there is a danger of explosion. The components of the charging cable can cause sparks and, therefore, may ignite flammable fumes or explosives.**

- **Always protect the connectors from moisture and from water and other fluids getting inside directly.**

- **For safety reasons, never perform other works on the vehicle while charging.**

- **Always complete the charging process before unplugging the connector from the electrical network. Otherwise the charging cable and the electrical installation may also be damaged.**

Note

- To charge the high-voltage battery using alternating current (AC), SEAT recommends using a home charging station or another type of charging station and charging with maximum charging power. These charging options are more efficient than using a domestic power socket.
- Please note the technical data on your vehicle's charging power. For more information, please contact a SEAT dealer.
- The high-voltage battery can only be charged at charging stations that meet the requirements of the country in questions and at least one of the following standards:
 - IEC 61851 and IEC 62196 [Europe]
- In the event of very low or very high temperatures, it may only be possible to charge the high-voltage battery in a limited manner.

Identification of compatible charging infrastructure

Valid for: hybrid vehicles

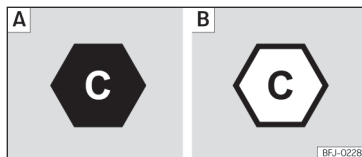


Fig. 58 Identification of alternating current (AC) and type 2 connector.

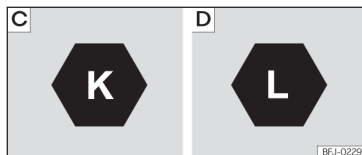



Fig. 59 Identification of direct current (DC) and the vehicle's CCS connector

Compatibility between vehicles and charging infrastructure

The following indicators according to the EN 17186 standard provide information about whether the infrastructure's charging connectors are suitable for the vehicle >>> .

Indicators >>> Fig. 58

- A** In the vehicle
- B** At the charging station

Indicators >>> Fig. 59

- C** Voltage up to 500 volts
- D** Voltage of up to 1000 volts.

The indicators are located on the vehicle's charging socket, on components of the local charging infrastructure (charging station, socket) and on the charging cable. The indicators refer to charging connection standards according to IEC 62196.

WARNING

Charging the vehicle at unverified electrical installations can cause serious injury and damage.

- If there is no indicator or if the charging infrastructure is unknown, an electrical installation expert should be consulted first.

Charging with alternating current (AC)

Valid for: hybrid vehicles

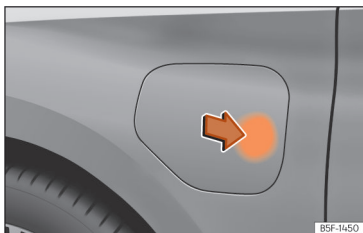


Fig. 60 Opening the charging socket cover.

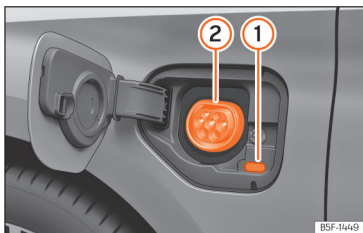


Fig. 61 Behind the battery charging cover on the front left-hand side: Charging socket

»» Fig. 61

- ① Charging process display
- ② Charging socket


The battery charger installed in the vehicle converts alternating current from the public supply into direct current.

AC charging station or socket cable: The vehicle's high-voltage battery can be charged using alternating current (AC) through the corresponding charging socket ②.

Connecting the charging cable

- Firstly, connect the charging cable to the socket, or public or home charging station. Next, fully unwind it.
- **Charging cable for domestic power sockets:** The protection device performs a self-test »» page 84.
- With the vehicle unlocked, the battery charging cover opens when the indicated zone is pressed »» Fig. 60.
- Plug the charging connector into the charging socket. Check that the charging connector is fully plugged in.

The connector locks automatically.

The LED (charging process display) on the charging socket lights up ①. The indicator lamp  lights up on the instrument cluster display.

You can set the charging as required in the information system »» page 81.

Automatic start of the charging process

If programmed charging is not activated, the charging process starts immediately. The external charging infrastructure must be active.

Most public charging stations require authentication to start the process. It is important to verify that the authentication has been performed correctly, otherwise it could cause a system malfunction.

During the charging

The indicator lamp  flashes green on the instrument cluster.

The charging process indicator on the charging socket flashes green ①. The charging connector is locked.

If the charging process indicator lights up red, there is a fault »» page 79.

Interrupt the charging process

The charging process can be interrupted:

- Unlock the vehicle.
- Press the function button to end the charging process. The charging process display on the charging socket lights up in white ①.
- Unlock the vehicle to unlock the charging connector.

To restart the charging process just press the function button to start the charging process.

After charging

When the high-voltage battery is fully charged, the charging process display on the charging socket lights up green.

- Unlock the vehicle.
- Unplug the charging connector from the charging socket within 30 seconds.
- Disconnect the charging cable from the power supply and replace the protective cap.
- Close the charging cover and make sure you hear it click into place.

First charge and charging after a long time

If the high-voltage battery is new or has not been charged for a long time, the maximum charge level of the battery can only be reached after several charging processes. This is for technical reasons and is not a vehicle malfunction.

If the vehicle is not used for a long period of time, the high-voltage battery must be charged at least once every four months.

Note

If you leave the charging cable connected after charging, the vehicle's electrical consumers will not drain the high-voltage battery.

Charging process display

Valid for: hybrid vehicles

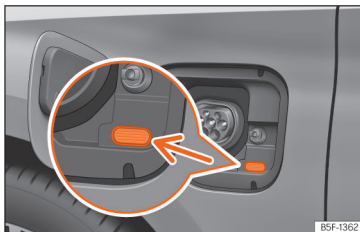


Fig. 62 Behind the battery charging socket cover: charging process indicator.

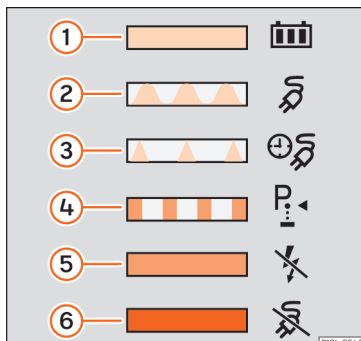


Fig. 63 On the inside face of the cover of the battery charging socket: sticker with information on the charging process display.

An LED light on the charging socket **>>> Fig. 62** (arrow) shows the status of the charging process.

A sticker on the battery charging cover provides information on the meaning of the LEDs **>>> Fig. 63**.

Charging process displays:

Green LED **>>> Fig. 63**

- ① **Always on:** Charge completed successfully.
- ② **Flashing:** The high-voltage battery is charging.
- ③ **Short flashes:** Programmed charging is active. The charging process has not yet started.

Yellow LED **>>> Fig. 63**

- ④ **Flashing:** The parking lock **P** has not been enabled.
- ⑤ **Always on:** No electrical network has been detected. Arrange an inspection of the power supply and network. Seek professional assistance.

Red LED **>>> Fig. 63**

- ⑥ **Flashing:** Error in the charging system. The charging process cannot start or has paused.
Always on: The charging connector has not been locked. Unplug the charging connector and plug it back in to the charging socket, making sure it is properly inserted.

If the problem persists, check the compatibility of the cable or ask a professional for help.

Charging socket lighting

In the dark, the charging socket's side lighting (white LED) can facilitate orientation in the vehicle:

On

- The vehicle has been unlocked.
- **OR:** The charging connector has been unplugged from the charging socket.

Off


- After unlocking or locking the vehicle, the lighting switches off automatically after a while.

Troubleshooting


Valid for: hybrid vehicles

The electrical system is not working properly. Stop safely!

The warning lamp lights up red. A message is displayed in this regard.


There is a fault in the high voltage system. The high voltage components may be damaged
>>> .

It is not possible to charge the high-voltage battery.

-  **The vehicle must be parked in a safe place.** Park the vehicle outdoors as soon as it is possible and safe to do so.
- Switch off the drive system.
- Seek professional assistance.

Error: drive system. Stop safely!

If this message is displayed on the instrument cluster and you also detect a burning or gassy smell or smoke, please note and follow the steps below:

-  **Stop driving!** Stop the vehicle immediately, taking into account the traffic situation.
- Choose a safe place outdoors, away from buildings or vehicles, canopies, covered car parks or similar places.
- Switch the ignition off.
- Before leaving the vehicle, make sure it is immobilised (parking brake, parking lock **P**).
- Leave the ignition key on the dash panel or in a visible place.
- Make sure that no people or animals remain inside the vehicle.
- Notify the emergency services.

WARNING

If there is a risk of fire in the high-voltage battery cells, toxic gases may be generated or high-voltage components may be live. There is a risk of severe burns, serious injury or fatal electric shock.

The charging process is not possible or has been paused

The charging process indicator located next to the charging socket lights up red.

Before visiting a specialist workshop, you can try the following solutions:

- Plug the charging cable back in.
- Check that the charging settings are as desired: "immediate" or "programmed".
- Check that the charging connector is plugged in correctly.
- Check if a fault is displayed on the charging station or, depending on the equipment, on the charging cable protection device.

If the fault cannot be rectified, contact a specialist workshop immediately.

WARNING

High-voltage components, including the battery and high-voltage cables, may be live and damaged. The high voltage system voltage is dangerous and can cause burns, other injuries and fatal electric shocks.

- **Do not touch the high voltage components!**

Emergency release of the charging connector

Valid for: hybrid vehicles

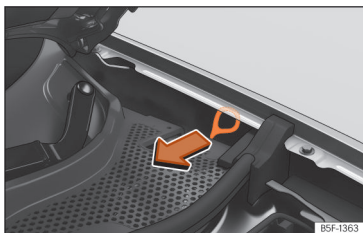


Fig. 64 Between the left wing panel and the engine bonnet hinge: Charging connector manual release mechanism puller.

Unlocking the charging connector

Prerequisites:

- The charging connector is plugged in correctly.
- The vehicle is unlocked.
- The charging process has ended or has paused »» page 76.

The manual release mechanism must be used if these prerequisites are met and it is still impossible to unplug the charging connector »» ⚠

Manual release of the charging connector

The puller for the manual release mechanism is on the left hand side of the engine compartment, above the charging socket »» Fig. 64.

- Disconnect the power supply at the charging station or electrical socket.
- Open the bonnet and make sure it is held in place with the prop.
- Pull the puller »» Fig. 64.
- Immediately unplug the charging connector.

⚠ WARNING

If the charging connector unexpectedly remains locked, the fault may be caused by the vehicle or charging station.

The manual emergency release can make live contacts accessible. In this case, touching the contacts of the charging socket may result in burns, other injuries or a fatal electric shock.

- **Never touch the contacts of the charging socket or the charging connector.**

i Note

The manual release mechanism of the charging connector should only be used in the event of a failure.

Charging settings in the infotainment system

Battery Manager Menu

✓ Valid for: hybrid vehicles

The **Battery Manager** allows you to set or select departure times for the programmed charging of the high-voltage battery and for the vehicle's electric heating and air conditioning.

Open the Battery Manager menu

- Switch the ignition on.
- Switch on the infotainment system.
- Select **Battery Manager** from the main menu.

It is possible to change the settings for immediate charging (the next charging process).

- Reduce the charging current, e.g. when other major consumers are operating on a single line of the electrical installation at the same time. Charging power is reduced and charging time is extended.
- Set the desired temperature for the independent air conditioning »» page 144.

Departure time settings menu

Programmed charging (departure times) can be set »» page 82.

- Specify the amount of time for which you want the high-voltage battery to charge and the air conditioning to be switched on inside the vehicle.

Extended independent air conditioning menu

- Set the desired temperature for the independent air conditioning >>> **page 144**.
- *Warm the seats and windscreen for departure*: select the seats in the Infotainment system or switch on windscreen heating. The active functions will be switched on during stationary air conditioning (either due to an immediate start or departure scheduling) if considered necessary by the air conditioning [cold conditions].

The air conditioning works both when the vehicle is connected to the grid and disconnected. If you want to use the high-voltage battery as the power supply, change the setting in the **Settings** menu.

Charging settings menu

It is possible to configure the general settings for the charging process.

- *Lower battery charge limit (minimum desired charge level of the high voltage battery)*: a minimum range can be ensured with this function. The vehicle charges directly once it has been

connected to a charging station or electrical socket. The function is available if a departure time has been activated >>> **page 82**.

- *Air conditioning using the high-voltage battery*: If the vehicle is not plugged in to an external network and this option is enabled, the electric range of the vehicle can be significantly reduced!

Departure time settings

✓ Valid for: hybrid vehicles

With programmed charging, the battery charge can be programmed and delayed so that the desired battery level is reached at a certain time when the vehicle is connected to the charging socket.

Viewing the departure times

- Select **Battery Manager** from the Infotainment main menu.
- Select ⌚ to open the overview of departure times.

Departure time settings

To set the desired departure time, touch the corresponding function button or check the box ✓.


- **Departure time**: Time, day of the week or set a single or weekly departure time.
- **Air conditioning**: the vehicle interior is heated or cooled by the departure time >>> **page 144**.
- **Trough or night-time tariff**: a preferred period of time for charging can be set.

Activating the departure time

Activate the departure time by checking the box in the departure times overview.

Displays:

 Charging activated at a departure time.

 Air conditioning switched on at a departure time.

 The departure time is used regularly.

Charging cable

Introduction

Valid for: hybrid vehicles

The type of charging cable supplied with the vehicle basically depends on the technical specifications of each country, e.g. charging connector connections for sockets.

SEAT recommends **exclusively** using the supplied charging cable.

Notes on the charging cable

- Handle with care.
- Unroll and roll fully.
- Do not twist or bend it over sharp edges.
- Do not crush it or drive the vehicle over it.
- Always unplug it by pulling on the connector.
- Children should not use the charging cable.
- Keep animals away from the charging cable.
- After use, store it safely and without twisting it.

Notes on charging connectors and the charging cable protection device

- Do not touch the charging connector's contacts.
- Protect from strong sunlight (outside temperatures no higher than 50°C or 122°F).
- Do not drop them.
- Protect from immersion in fluids such as rain water.
- Fit the protective caps after each use.

Cleaning the charging cable

Clean the surface of the charging cable with a dry or slightly damp cloth »» » ⚠, »» » ⓘ.

⚠ WARNING

Items that are not secured, or incorrectly secured can cause serious injury during sudden manoeuvres or braking, or in the event of an accident.

- Store the charging cable securely in the luggage compartment.
- Use the organizer/protective cover provided with the cable for this purpose.

⚠ WARNING

Using a charging cable that has been damaged or tampered with can cause serious injury and fatal electric shocks.

- Before each use check that the connectors and the charging cable are undamaged, e.g. check for cracks.
- Never disassemble the charging cable or its components.
- Never use a charging cable that is damaged or has been tampered with.
- If the charging cable does not work properly, get a SEAT dealer to check it.

⚠ WARNING

The charging cable for electrical sockets must always be connected directly to an electrical socket. Failure to do so could result in fire damage and damage to the charging cable or home electrical installation.

- Never connect the charging cable to an extension lead, cable reel, power strip or adapter or timer.

⚠ WARNING

The high voltage system voltage is dangerous and can cause burns, other injuries and fatal electric shocks.

- Only clean the charging cable when it is unplugged.

ⓘ NOTICE

Seek information regarding the appropriate charging cable and the maximum permitted charging current before travelling abroad. If possible, use the charging cable supplied in the country in question.

ⓘ NOTICE

The charging cable, as portable electrical equipment, may have to be checked periodically. This requires a test adapter.

NOTICE

The charging cable can be damaged if not cleaned properly.

- Only water should be used for this purpose, and never additional cleaning products.
- Water should be prevented from getting into the contacts.

For the sake of the environment

Charging cables must be disposed of in an environmentally friendly way and should not be thrown in the household waste.

Note

The maximum charging capacity of the safety circuit that is used must be observed. If the charging cable is plugged into an electrical socket on the same circuit as other consumers, the circuit's fuses may trip.

Charging cable for alternating current (AC) charging stations

Valid for: hybrid vehicles

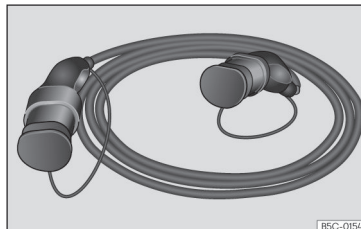


Fig. 65 Charging cable for alternating current (AC) charging stations.

The maximum charging current is 16 or 32 amps, depending on the vehicle's features and the charging cable that is supplied >>> ⚠.

WARNING

Charging the high-voltage battery with an inappropriate charging cable could cause short circuits, serious injuries and fatal electrical shocks.

WARNING

The charging cable should not be used as an extension lead. The charging process could be affected.

NOTICE

Follow the manufacturer's instructions and indications when using the charging station.

Note

Charging with a charging cable for 16 A is not possible at some charging stations that support 32 A. This depends on the charging station's equipment.

- Before charging the vehicle, find out about the available charging technology.

Charging cable for power sockets

Valid for: hybrid vehicles

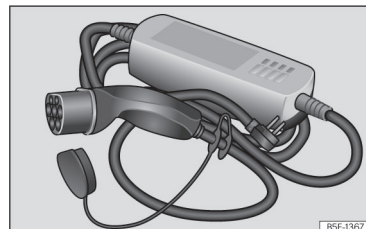


Fig. 66 Charging cable for electrical sockets

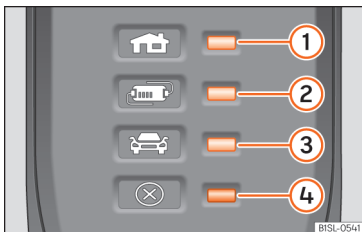


Fig. 67 On the charging cable for power sockets: Indicator lamps on the protection device.

»» Fig. 67:

- ① Indicator lamp of the connector and the power supply.
- ② Control lamp of the protection device
- ③ Control lamp of the vehicle
- ④ Failure warning lamp

Charging cable information

Before using the charging cable, also follow the instructions displayed on it and on the rear of the protective device.

Protection device

The electronic protection device »» Fig. 67 ensures that the charging connector does not receive current until it is plugged in to the vehicle's charging connector.

Self-check

When the charging cable is plugged into the electrical socket, the protective device automatically performs a self-test. During this check, all warning and indicator lamps turn on briefly and go out one after the other. Upon completion, the operational status at that time is displayed.

Operating displays

One or more control lamps »» Fig. 67 ①, ② or ③ light up green.

Display »» Fig. 67	Meaning
① ignition	The charging cable is plugged into the mains
①, ② on, ③ flashes slowly »» page 85	The high-voltage battery is charging.
① ② and ③ on	The charging process is complete. The high-voltage battery has charged.

Set the charging current

The charging cable limits the charging current according to the available power supply.

If the local mains supply does not allow charging at the maximum charging current, the charging current can be reduced, depending on the charging setting features in the infotainment system »» page 82.

Temperature control

The charging cable temperature control switches on when the charging cable overheats, such as when it has been stored in a luggage compartment exposed to high temperatures or strong sunlight.

Display »» Fig. 67	Meaning
①, ④ flashing	The housing connector has overheated.
②, ④ flashing	The protection device has overheated.

If the charging process continues with a lower current, both the operating indicator and the warning lamp »» Fig. 67 ④ flash red.

- Unplug the charging cable from the mains and wait for it to cool down.
- If it disconnects again, or the charging current reduces and the cause does not seem to be exposure to an external heat source, make sure that the green control lamp is flashing »» Fig. 67. To check the charging cable, please visit a SEAT dealer. Get an establishment that specialises in electrical installations to check the infrastructure connection.

Fault display

If the red warning light ④ flashes or turns on without one of the indicator lamps »» Fig. 67 ①, ② or ③ also turning on continuously on the status indicator, there is a fault.

Display >>> Fig. 67	Meaning
① flashing, ④ on or flashing	Failure in the power supply.
② flashing, ④ on or flashing	Failure in the protection device.
③ flashing, ④ on or flashing	Failure in the vehicle.

The charging process pauses or is cancelled.

- Check the instructions located on the back of the protective devices.
- Seek professional assistance if the fault persists.

Note

If there is any other mains connection during the charging process, or if the vehicle is right next to the high voltage cables, charging from an electrical socket is not possible in some cases. Additional mains connections:

- Connecting a 12 volt battery charger.
- Contact with a work tool connect to the mains, such as a vehicle lift.

Opening and closing

Set of vehicle keys

Vehicle key

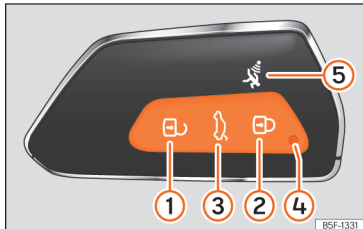


Fig. 68 Vehicle key



Fig. 69 Centre console: vehicle key housing.

- ① Unlock the vehicle
- ② Lock the vehicle

- ③ Unlock only the rear lid. Press the button until all the turn signals on the vehicle flash briefly. You have 2 minutes to open the rear lid. Once this time has passed, it will lock again. In addition, the lamp on the key flashes.
- ④ Control lamp
- ⑤ Alarm button. Only press in the event of an emergency! When the alarm button is pressed, the vehicle's sounds and the turn signals light up for a short time. Press again to disconnect.

The vehicle can be locked and unlocked from a distance using the vehicle key »» page 93.

The vehicle key includes an emitter and battery. The receiver is in the interior of the vehicle. The range of the vehicle key with remote control and new battery is several metres around the vehicle.

If it is not possible to open or close the vehicle using the remote control key, this should be re-synchronised »» page 89 or the battery changed »» page 89.

Different keys belonging to the vehicle may be used.

Control lamp on the vehicle key

When a button is pressed briefly on the vehicle key, the control lamp ④ »» Fig. 68 flashes once briefly, but if pressed for a long period of time, it will flash several times, for example, in the convenience opening.

If the vehicle key control lamp does not light up when the button is pressed, replace the key's battery »» page 89.

Key socket

Depending on the version, there is a housing for the key close to the start button »» Fig. 69. **Warning!** Do not confuse with the location for the emergency start »» page 156.

Spare key

To obtain a spare key and other vehicle keys, the vehicle chassis number is required.

Each new key contains a microchip which must be coded with the data from the vehicle electronic immobiliser. A vehicle key will not work if it does not contain a microchip or the microchip has not been encoded. This is also true for keys which are specially cut for the vehicle.

The vehicle keys or new spare keys can be obtained from a SEAT Official Service, a specialised workshop or an approved key service qualified to create this kind of key.

New keys or spare keys must be synchronised before use »» page 89.

⚠ WARNING

- Never leave children or disabled persons in the vehicle. In case of emergency, they may not be able to leave the vehicle or manage on their own.
- An uncontrolled use of the key by third parties could activate a piece of electrical equipment (e.g. electric windows), with the resulting accident hazard. The doors can be locked using the remote control key. This could become an obstacle for assistance in an emergency situation.
- Never forget the keys inside the vehicle. An unauthorised use of your vehicle could result in injury, damage or theft. Therefore always take the key with you when you leave the vehicle.

ⓘ NOTICE

All of the vehicle keys contain electronic components. Protect them from damage, impacts and humidity.

📌 Note

- Only use the key button when you require the corresponding function. Pushing the button unnecessarily could accidentally unlock the vehicle or trigger the alarm. It is also possible even when you are outside the radius of action.

- Key operation can be greatly influenced by overlapping radio signals close to the vehicle working in the same range of frequencies, for example, radio transmitters or mobile telephones.
- Obstacles between the remote control and the vehicle, bad weather conditions and discharged batteries can considerably reduce the range of the remote control.
- If the buttons of the vehicle key are pressed or one of the central locking buttons >>> page 94 is pressed repeatedly in short succession, the central locking briefly disconnects as protection against overloading. The vehicle is then unlocked. Lock it if necessary.
- Spare remote control keys are available at your Technical Service, where they must be matched to the locking system.

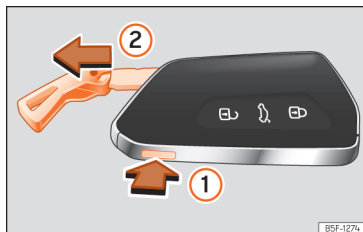
Pull out the key blade

Fig. 70 Vehicle key: remove the key shaft.

The central locking remote control has the key blade inside it for use in case of emergency locking/unlocking of the driver's door >>> page 98.

- Press the >>> Fig. 70 ① button to release the ring from the key fob and remove the key blade ②. Pressing lightly on the ring leaves it fixed as a key fob.
- Press the >>> Fig. 70 ① button to unlock. Press and hold button ① and at the same time pull on the ring in the direction of arrow >>> Fig. 70 ② to completely remove the key shaft.

Changing the battery

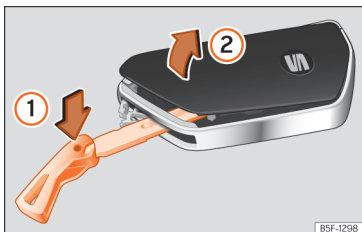


Fig. 71 Vehicle key: open the battery compartment cover.

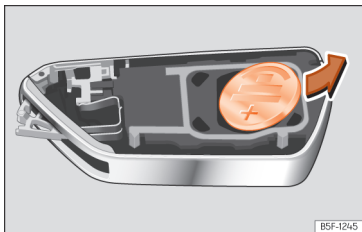


Fig. 72 Vehicle key: removing the battery.

SEAT recommends you ask a specialised workshop to replace the battery.

The battery is located to the rear of the vehicle key, under a cover.

Changing the battery

- Remove the key blade from the vehicle key >>> page 89.
- Insert the key blade into the slot >>> Fig. 71, press it in the direction of arrow ① and detach the cover by levering it ②.
- Remove the battery from the compartment with a suitable fine object >>> Fig. 72.
- Insert the new battery and press it into the battery compartment >>> ①.
- Place the cover and press it into the vehicle key housing until it clicks into place.

⚠ WARNING

Swallowing a battery with a 20 mm diameter or any other button battery can cause serious and even fatal injuries within a very short time.

- Keep the vehicle key and key fobs with batteries out of reach of children.
- If you suspect that someone may have swallowed a battery, seek immediate medical attention.


ⓘ NOTICE


- If the battery is not changed correctly, the vehicle key may be damaged.
- Use of unsuitable batteries may damage the vehicle key. For this reason, always replace the dead battery with another of the same voltage, size and specifications.
- When fitting the battery, check that the polarity is correct.

♻ For the sake of the environment


Please dispose of your used batteries correctly and with respect for the environment.

Synchronize the vehicle key

If the  button is pressed frequently outside of the vehicle range, it is possible that the vehicle can no longer be locked or unlocked using the key. In this case, the key must be resynchronised as described below:

- Stand next to the vehicle.
- Briefly press the  button on the vehicle key twice.

OR:

- Remove the emergency key >>> page 87.
- Press the  button on the key.
- Unlock the vehicle with the emergency key.

- Open the driver's door. If the vehicle is fitted with an anti-theft alarm, it will trigger immediately »» page 96.
- Switch the ignition on. *Please note:* to turn on the ignition, place the vehicle key at the bottom of the central armrest box, as close as possible to the Kessy logo 📍.

This completes the synchronization.

Keyless Access system

Locking and unlocking with the Keyless Access system

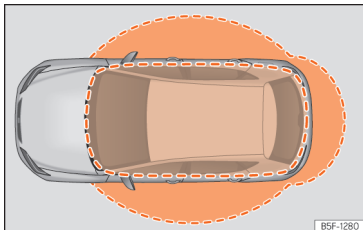


Fig. 73 Keyless Access: proximity zones.

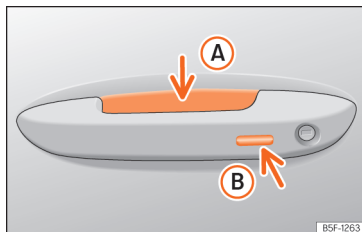


Fig. 74 Door handle: sensor surfaces.

»» **Fig. 74**

- A** Unlocking sensor surface on the inside of the door handle.
- B** Locking sensing surface on the outside of the door handle.

Depending on the equipment, the vehicle may have the Keyless Access system. This is a keyless locking and starting system that can unlock and lock the vehicle without actively using its key. For this, it is only necessary that there is a valid vehicle key in the detection area corresponding to the attempted access to the vehicle.

Configuring the Keyless Access system

The behaviour of the Keyless Access system can be adjusted in the **Vehicle settings** menu of the Infotainment system »» page 38.

If the Keyless Access function is disabled, its operation is limited.

Unlock the vehicle

- Touch the sensor surface on the inside of the handle **A**. All turn signals flash twice.

If selective opening is fitted, touching the sensor's surface twice unlocks the entire vehicle.

If the vehicle is not unlocked for an extended period, the function is deactivated. The function will reactivate the next time that the vehicle is unlocked with the remote control.

Lock the vehicle

- Park the vehicle.
- Touch the sensor surface »» **Fig. 74 B** on the outside of the door handle. All turn signals flash once.

To check that the vehicle is properly locked, the unlocking function is deactivated for a few seconds.


Unlocking the rear lid

When the vehicle is locked, the rear lid automatically unlocks when it is opened if there is a vehicle key in its proximity zone. The rear lid locks again after closing.

Temporarily deactivating the Keyless Access system

The "Keyless Access" system's unlocking function can be temporarily deactivated:

• Move the gear lever to position **P** since otherwise the vehicle cannot be locked.

• Lock the vehicle using the  button on the vehicle key.

• Within 5 seconds, touch the sensor on the outside of the door handle once **>>> Fig. 74 (B)**. Do not grip the handle while doing so. This temporarily deactivates the Keyless Access system.

• Check that it is deactivated by pulling on the door handle after at least 10 seconds. It should not be possible to open the door.

The next time, the vehicle can only be unlocked electronically with the vehicle key. After being unlocked the next time, the Keyless Access system will be activated again **>>> ①**.


Permanently disabling the Keyless Access system

The Keyless Access system can also be permanently deactivated in the infotainment system **>>> ①**.

Comfort functions

To close all the electric windows and the sunroof using the **comfort function**, keep a finger for a few seconds on the locking sensor surface **>>> Fig. 74 (B)** of the door handle until the windows and roof have closed.

How the **doors open** when touching the sensor surface on the door handle will depend on the settings that have been activated in the

infotainment system, using the function button  **> Vehicle > Exterior > Central Locking**.

! NOTICE

Deactivating the Keyless Access system also deactivates the sensor controlled opening and closing of the rear lid, although the function is shown as "active" in the vehicle menu.

Troubleshooting

The Keyless Access system does not work

The operation of the sensor surfaces may be limited if they are soiled.

- Clean the sensor surfaces.

All turn signals flash four times

The key that was last used is still inside the vehicle.


- Remove the key and lock the vehicle.

Automatic deactivation of the sensor surfaces

The sensor surfaces are deactivated in the following cases:

- If the vehicle is not unlocked or locked for a long period of time.
- If any of the sensor surfaces are activated unusually often.

To reactivate the sensor surfaces:

- Unlock the vehicle using the  button on the vehicle key.

! NOTICE

The sensor surfaces on the door handles may activate if hit by a jet of water or high pressure steam if there is a valid vehicle key in the proximity area. If at least one of the windows is open and the sensor surfaces on one of the handles permanently activates, all of the windows will close. If the jet of water or steam is briefly moved away from the sensor surfaces of one of the handles and redirected towards them, all of the windows may open.

i Note

If the message **Keyless system faulty** is displayed on the instrument cluster display, abnormalities may occur in the operation of the Keyless Access system. Contact a specialised workshop.

i Note

If there is no vehicle key inside the vehicle or the system fails to detect one, a warning will display on the instrument cluster screen. This could happen if any other radio frequency signal interferes with the key signal or if the key is covered by another object, e.g. a metal case.

Central locking

Introduction

Central locking functions correctly when all the doors and the rear lid are correctly shut. If the driver door is open, the vehicle cannot be locked with the key.

WARNING

The incorrect use of the central locking system may cause serious injuries.

- The central locking system will lock all doors. A vehicle locked from the inside can prevent any non-authorised individual from opening the doors and accessing the vehicle. Nevertheless, in case of emergency or accident, locked doors will complicate access to the vehicle interior to help the passengers.
- Never leave children or disabled people alone in the vehicle. The central locking button can be used to lock all the doors from within. Therefore, passengers will be locked inside the vehicle. Individuals locked in the vehicle can be exposed to very high or very low temperatures.
- Depending on the time of the year, temperatures inside a locked and closed vehicle can be extremely high or extremely low resulting in serious injuries and illness or even death, particularly for young children.

- Never leave individuals locked in a closed and locked vehicle. In case of emergency, they may not be able to exit the vehicle by themselves or get help.

Description

Central locking allows all doors, the rear lid and the tank flap to be unlocked centrally:

Hybrid vehicles: the fuel tank flap does not unlock with the central locking »» page 306.

- From outside, using the vehicle key »» page 93.
- From outside with the Keyless Access system »» page 90.
- From inside, by pushing the central locking button »» page 94.


Self-locking system to prevent involuntary unlocking

It is an anti-theft system and prevents the unintentional unlocking of the vehicle. If the vehicle is unlocked and none of the doors (including the boot) are opened within 45 seconds, it relocks automatically.

Automatic locking (Auto Lock)

The vehicle locks automatically at over a speed of approx. 15 km/h (9 mph). The fuel tank flap is unlocked so that you can refuel without getting out of the vehicle.

Hybrid vehicles: the fuel tank flap remains locked »» page 306.

When the vehicle is locked, the control lamp  of the central locking button lights up yellow.

Automatic unlocking (Auto Unlock)

If one of the following conditions is met, all doors and the rear lid are unlocked automatically:

- The electronic parking brake is engaged and the ignition is switched off.
- **EITHER:** the inside door handle has been pulled. This applies when driving at under 15 km/h (9 mph).
- **OR:** in the event of an accident and an airbag has been triggered »» page 95.

Automatic unlocking allows third parties to access the interior of the vehicle to provide assistance if necessary.

Turn signals

The turn signals will flash twice when the vehicle is unlocked and once when the vehicle is locked.

If it does not flash, this indicates that one of the doors, the rear lid or the bonnet is not closed correctly.

Accidental lock-out

If you have left the key in the vehicle, it cannot be locked in the following cases:


- If the driver door is open, the vehicle cannot be locked with the central locking switch »» page 94.

Lock the vehicle with the remote control key, when all the doors and the rear lid have been closed. This prevents the accidental locking of the vehicle.


Central locking settings


Central locking settings can be changed in the Infotainment system.

Selective unlocking of the doors

- Press the function button  > **Vehicle** > **Exterior** > **Central locking** > **Door unlocking**.

You can choose to unlock **all** the doors or only the **driver door** when you unlock the vehicle. In all the options, the fuel tank flap is also unlocked.

With the **Driver** setting, when you press the  button on the remote control key once, only the driver door is unlocked. If that button is pressed twice, the rest of the doors and the rear lid will be unlocked.

If the  button is pressed, all the vehicle doors are locked. At the same time, a confirmation signal is heard.

Note

- **Never leave any valuable items in the vehicle unattended. Not even a locked vehicle is a safe.**
- **If the LED on the driver door sill lights up for about 30 seconds when the vehicle is locked, the central locking system or anti-theft alarm is not working properly. You should have the fault repaired at a SEAT Official Service or specialised workshop.**
- **Vehicle interior monitoring by the anti-theft alarm system will only function as intended if the windows and sunroof are closed.**

Unlock and lock with the key

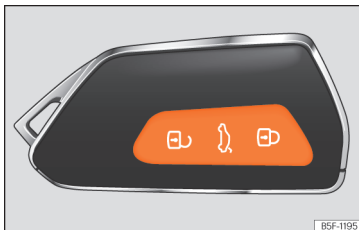







Fig. 75 Remote control key: keys.

- Lock: press the  »» **Fig. 75** button.
- Locking the vehicle without the “Safe” security system: push the  button again and hold for 2 seconds.



- Unlock: press the  button.
- Unlocking the rear lid: hold down the  button for at least 1 second.

The vehicle will be locked again automatically if you do not open one of the doors or the rear lid within 45 seconds after unlocking the car. This function prevents the vehicle from remaining unlocked if the unlocking button is pressed by mistake. This does not apply if you press the  button for at least one second.

Selective unlocking system

The selective unlocking system allows you to only unlock the driver door and the fuel tank flap. All other doors and the rear lid remain locked.

Unlocking the driver's door and tank flap:

- Press (once) the  button on the remote control key or turn the key once in the opening direction.
- Unlocking all the doors, the rear lid and the tank flap simultaneously:*
- Within 5 seconds, press (twice) the  button on the remote control key, or turn the key twice within 5 seconds in the opening direction.

The “Safe” security system and the anti-theft alarm deactivate immediately when only the driver door is opened.

In vehicles with Infotainment system, you can programme the security central locking system directly »» page 92.

WARNING

Observe the safety warnings >>> page 94, *Safe security system*.

Note

- For safety reasons it is advisable to only activate the remote control key when you can see the vehicle.
- Other functions of the remote control key >>> page 104, *Opening and closing the windows*.

Unlocking and locking from the inside



Fig. 76 On the centre console: central locking button

- Lock: press the >>> Fig. 76 button.
- Unlock: Press the >>> Fig. 76 button again.

Please note the following when using the central locking switch to lock your vehicle:

- It is not possible to open the doors or the rear lid from the *outside* (for safety reasons, e.g. when stopped at traffic lights).
- The central locking button lamp lights up when all the doors are closed and locked.
- You can open the doors individually from the inside by pulling the inside door handle.
- The fuel tank flap remains unlocked.

Hybrid vehicles: the fuel cap remains locked >>> page 306.

- In the event of an accident in which the airbags inflate, doors locked from the inside will be automatically unlocked to facilitate access and assistance.

WARNING

- The central locking button also works with the ignition switched off, except when the “Safe” security system is activated.
- The central locking button does not operate if the vehicle is locked from the outside and the security system is switched on.
- Locked doors could delay assistance in an emergency. Do not leave anyone, especially children, in the vehicle.

Note

Your vehicle will lock automatically when it reaches a speed of approximately 15 km/h (9 mph) [Auto Lock] >>> page 92. You can unlock the vehicle again using the key of the central locking button.

“Safe” security system

Depending on its equipment, the vehicle may be fitted with the “Safe” security system.

When the vehicle is locked, the “Safe” security system puts the door handles out of operation and hinders possible attempts by people to access the vehicle. The doors cannot be opened from inside >>> .

The instrument cluster may display an indication that the “Safe” security system is switched on.

Disabling the “Safe” security system

The “Safe” security system may be disabled in any of the following ways:

- Press the vehicle key button again **within 2 seconds**.
- Touch the sensor surface on the outside of the door handle again **within 2 seconds** >>> page 90.
- Switch the ignition on.
- **OR:** deactivate interior monitoring and the anti-tow system >>> page 96.

Depending on the equipment, before locking the vehicle temporarily deactivate interior monitoring and the anti-tow system in the **Vehicle settings** menu of the infotainment system »» page 96.

When the "Safe" security system is deactivated, the following needs to be taken into account:

- The vehicle can be unlocked and opened from the inside using an door handle.
- The anti-theft alarm is active »» page 96.
- The interior monitoring system and the anti-tow system are disabled »» page 96.

"Safe" status

The flashing frequency of the diode in the door sill immediately confirms the process. Initially, the diode flashes in a fast sequence for a brief period, then it stops for approximately 30 seconds and, lastly continues flashing slowly.

WARNING

Using the "Safe" security system negligently or without paying due attention can cause serious injuries in the event of an emergency.

- Never leave anyone inside the vehicle when you lock it with the key. When the "Safe" security system is active the doors cannot be opened from the inside!

Troubleshooting

The control lamp remains on

The red LED on the driver's door flashes at short intervals and then stays on. There is a fault in the locking system.

- Contact a specialised workshop. SEAT recommends visiting a SEAT dealership for this.

The turn signals do not flash

If the turn signals do not flash as a confirmation when the vehicle is locked:


- At least one door or the rear lid are not closed **or**
- The engine bonnet is not closed.

The vehicle locks automatically

If one of the following conditions is met, the vehicle re-locks automatically after approx. 45 seconds.

- The vehicle has been unlocked, but none of the doors or the rear lid have been opened.
- The ignition has not been switched on.
- The vehicle has been unlocked with the locking cylinder.
- The vehicle has been locked with the button located in the vehicle interior.

What happens when locking the vehicle with a second key

They key inside the vehicle is blocked and cannot be used to start the engine as soon as the vehicle is locked from the outside with a second key. To activate the key inside the vehicle to allow it to switch on the engine, press its  button.

Locking the vehicle after an airbag is triggered

When an airbag is triggered as a result of an accident, the vehicle is fully unlocked. Depending on the extent of the damage, the vehicle may be relocked after the accident as described below:

- Switch the ignition off.
- Open the driver's door and close it again.
- Lock the vehicle.

Note

If the 12-volt vehicle battery has little or no charge, or the vehicle key battery is almost or entirely out of charge, you will probably not be able to lock or unlock the vehicle with the Keyless Access system. The vehicle can be unlocked and locked manually »» page 98.

Note

If there is no vehicle key in the vehicle or the system does not detect it, a warning will be displayed on the instrument cluster. This could happen if any other radio frequency signal interferes with the key signal or if the key is covered by another object, e.g. a metal case.

Anti-theft alarm

Description

Depending on the equipment, the vehicle may be fitted with an anti-theft alarm.

The theft alarm monitors the doors, bonnet and rear lid.

The anti-theft alarm system activates automatically when the vehicle is locked.


If the vehicle is not opened electronically with a valid key, the alarm triggers and emits audio and light signals for a maximum of approx. 5 minutes.

When is the anti-theft alarm triggered?

• If a mechanically unlocked door is opened with the vehicle key, you have 15 seconds to switch on the ignition before the alarm is triggered (depending on markets, the 15 seconds waiting time disappears and the alarm is triggered immediately when the door is opened).

- If the bonnet is opened.
- If the rear lid is opened.
- If an invalid vehicle key is used.
- If there are movements inside the vehicle (in vehicles with interior monitoring ››› page 96).
- If the vehicle is lifted or towed (for vehicles with an anti-tow system ››› page 96).
- If the vehicle is transported on a ferry or by rail (in vehicles with an anti-tow system or interior monitoring ››› page 96).
- If the 12-volt battery is disconnected.
- If the window is broken.
- When a trailer connected to the theft alarm system is unhitched.


Switching off the alarm

- Unlock the vehicle with the vehicle key unlocking button .
- Grip the door handle.
- Switch the ignition on. *Please note:* to turn on the ignition, place the vehicle key in the area provided for it to perform an emergency start.

Note

- **After 28 days, the indicator light will be switched off to prevent the battery from exhausting if the vehicle has been left parked for a long period of time. The alarm system remains activated.**

• If, after the audible warning goes off, another monitored area is accessed (e.g. the rear lid is opened after a door has been opened), the alarm is triggered again.

• The anti-theft alarm is not activated when the vehicle is locked from within using the central locking button .

• If the driver door is unlocked mechanically with the key, only the driver door is unlocked, the rest of the doors remain locked. Only when the ignition has been turned on will the other doors be available - but not unlocked - and the central locking button will be activated.

• Vehicle monitoring remains active even if the battery is disconnected or not working for any reason.

Interior monitoring and anti-tow system

If movement is detected in the vehicle interior while the vehicle is locked, the interior monitoring triggers the alarm.



If it detects that the vehicle is being lifted, the anti-tow system triggers the alarm.

Switching on the interior monitoring and the anti-tow systems


• Lock the vehicle. When the anti-theft alarm is activated, the interior monitoring and the anti-tow system are as well.

Depending on the equipment, the use of a partition net can affect the operation of the interior monitoring system.

Temporarily switching off the interior monitoring and anti-tow systems

- Open the vehicle with the key, either mechanically or by pressing the  button on the remote control. The time period from when the door is opened until the ignition is turned on should not exceed 15 seconds, otherwise the alarm will be triggered.
- Press the  button on the remote control twice. The interior monitoring and the anti-tow systems will be deactivated. The alarm system remains activated.

Disconnect through the infotainment system

- Press the function button  > **Vehicle** > **Exterior** > **Central locking** > **Interior monitoring**.

The interior monitoring and anti-tow system remain deactivated until the next time the vehicle is locked.

Interior monitoring and the anti-tow system can also be switched off in the departure menu.

To do this, the ignition must be switched off
»» page 152.

To avoid false alarms, deactivate interior monitoring and the anti-tow system in the following situations:

- When people or animals remain inside the vehicle.
- When the vehicle is to be loaded onto another means of transport, transported or towed.
- When the vehicle is to be left in a car wash or is to be parked in a double-decker garage.

Risk of false interior monitoring alarms

The interior monitoring system will only operate correctly if the vehicle is completely locked. Please bear in mind all legal provisions. The following situations may cause a false alarm:

- If one or more windows are partially or completely open.
- If the sliding/tilting roof is partially or fully open.
- If light objects are left inside the vehicle, e.g. loose paper or items hanging from the interior mirror.
- If the vibrate function of a mobile left inside the vehicle is activated.

Note

- It is not possible to permanently deactivate the interior monitoring and anti-tow systems.
- If any doors or the rear lid are open when the anti-theft alarm is activated, only the alarm will be activated. The interior monitoring and anti-tow systems will only activate once all of the doors and the rear lid are closed.

- When the interior monitoring and anti-tow systems are switched off, the "Safe" security system is also switched off »» page 94.

Doors

Introduction

The doors and rear lid can be locked manually and partially opened, for example if the key or the central locking is damaged.

WARNING

Opening and closing doors carelessly can cause serious injury.

- If the vehicle is locked from outside, the doors and windows cannot be opened from the inside.
- Never leave children or disabled people alone in the car. They could be trapped in the car in an emergency and will not be able to get themselves to safety.
- Depending on the time of the year, temperatures inside a locked and closed vehicle can be extremely high or extremely low resulting in serious injuries and illness or even death, particularly for young children.

⚠ WARNING

Getting in the way of the doors and the rear lid is dangerous and can lead to serious injury.

- Open and close the doors and the rear lid only when there is nobody in the way.

ⓘ NOTICE

In certain weather conditions, ice or snow may accumulate on the lower front part of the doors between the door frame and the door; do not force the doors open until you are sure that there is no ice or snow.

ⓘ NOTICE

When opening and closing in an emergency, carefully disassemble components and then reassemble them carefully to avoid damage to the vehicle.

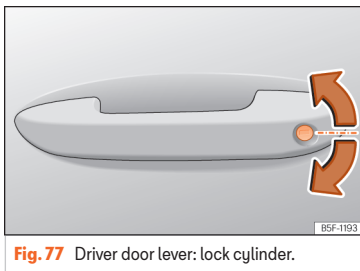
Emergency unlocking or locking of the driver's door

Fig. 77 Driver door lever: lock cylinder.

If the central locking system should fail to operate, the driver door can still be locked and unlocked by turning the key in the lock.

As a general rule, when the driver door is locked manually all other doors are locked. When it is unlocked manually, only the driver door opens. Please observe the instructions relating to the anti-theft alarm system »» page 96.

- Remove the key blade from the vehicle key »» page 88.
- Insert the key blade into the lock cylinder to unlock or lock the vehicle.

Special characteristics

- The anti-theft alarm will remain active when vehicles are unlocked. However, the alarm will not be triggered »» page 96.
- After the driver door is opened, you have 15 seconds to switch on the ignition. Once this time has elapsed, the alarm is triggered.
- Switch the ignition on. The electronic immobilizer recognises a valid vehicle key and deactivates the anti-theft alarm system.

ⓘ Note


The anti-theft alarm is not activated when the vehicle is locked manually using the key shaft »» page 92.

Emergency lock of doors without lock cylinders

Fig. 78 Locking the door manually.

If the central locking system fails or the vehicle's battery goes flat, doors with no lock cylinder will have to be locked separately.

The emergency lock is located on the front of the front passenger's door and the rear doors. It can only be seen if the door is open.

- If necessary, remove the rubber seal  from the front of the door »» Fig. 78.
- Insert the key in the inside slot and turn it to the right as far as it will go (if the door is on the right side) or to the left (if the door is on the left side).
- Replace the cap.

Once the door has been closed it can no longer be opened from the outside. Pull the interior door handle once to unlock and open the door.

Child lock



Fig. 79 Left door child lock.

The child lock prevents the rear doors being opened from the inside. Its function is to prevent children from inadvertently opening a single door while the vehicle is in motion.

This function is separate from the vehicle's electronic unlocking/locking systems. It only works on the rear doors. It can only be activated and deactivated manually, as described below.

Activating the child lock

- Unlock the vehicle and open the door on which the child safety lock is to be activated.
- With the door open, turn the slot with the vehicle key clockwise for the left doors »» Fig. 79 and anticlockwise for the right doors.

When the child lock is activated, the doors can only be opened from the outside.

Deactivating the child lock

- Unlock the vehicle and open the door from which you want to remove the child lock.
- With the door open, turn the slot with the vehicle key anticlockwise for the left doors »» Fig. 79 and clockwise for the right doors.

WARNING

The doors cannot be opened from the inside when the child lock is activated. This means that people may be locked inside the vehicle. In an emergency, they may not be able to leave the vehicle independently or save themselves.

- Never leave children or persons in need of assistance unattended in the vehicle when the doors are locked.

WARNING

If children, persons requiring assistance or animals are left unattended inside the vehicle, they could be exposed to very high or very low temperatures. There is a risk of serious or fatal injuries.

- Never leave children, persons in need of assistance or animals unattended in the vehicle.

Rear lid

Introduction

The rear lid unlocks and locks together with the doors.

On vehicles with the Keyless Access start/locking system, the rear lid automatically unlocks when it is opened »» page 90.

⚠ WARNING

Careless and unsuitable locking, opening and closing of the rear lid can cause accidents and serious injury.

- Do not close the rear lid by pushing it down with your hand on the rear window. The glass could smash. Risk of injury!
- Ensure the rear lid is locked after closing it. If not, it may open unexpectedly while driving.
- Never open or close the rear lid carelessly or in an uncontrolled manner, as this could cause serious injuries to you or third parties. Make sure that no person or object is in the way of the rear lid as it closes or opens.
- Never drive with the rear lid open or half-closed, exhaust gases may penetrate into the interior of the vehicle. Danger of poisoning!
- Never open the rear lid if there is cargo, e.g. bicycles, attached to it. The rear lid may close by itself due to the additional weight. If necessary, remove the cargo first or hold the rear lid.
- Never leave the vehicle unattended or allow children to play inside or next to it, especially if the rear lid is open. Children could enter the luggage compartment, close the rear lid and become trapped. A locked vehicle can reach extremely high and low temperatures, depending on the time of year, thus causing serious injuries, illness or even death.

ⓘ NOTICE

- Before opening or closing the rear lid, make sure that there is enough space to open or close it, e.g. when pulling a trailer or in a garage.
- Never use the rear wiper or rear spoiler to secure cargo or as a handhold. This could cause damage that could lead to the breakage of the rear wiper or spoiler.



ⓘ Note

Before closing the rear lid, make sure that the key has not been left inside the luggage compartment.

Opening and closing the rear lid

Fig. 80 Rear lid: opening from the outside.

The rear lid opening system operates electrically.

To lock or unlock the rear lid, press the  or  buttons of the vehicle key.

Opening and closing

- **Open:** press the top of the SEAT emblem and lift the rear lid. The rear lid opens automatically **>>> Fig. 80.**
- **Close:** grip the rear lid by one of the handles on the interior trim and move it downwards to close.

OR: press the button on the rear lid **>>> Fig. 81.**

If the doors are locked, the rear lid is also locked.

A warning appears on the instrument panel display if the rear lid is open or not properly closed.

The rear lid locks automatically while driving.

When the outside temperature is around freezing point, the opening mechanism cannot always raise the rear lid. Lift the rear lid by hand.

ⓘ Note

If the rear lid is not opened within a few minutes of being unlocked, it re-locks automatically.

Rear lid with electric opening and closing

Valid for: Leon Sportstourer

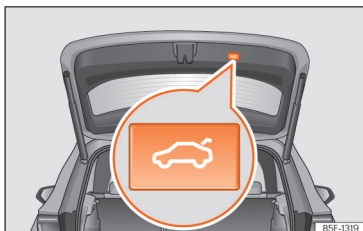


Fig. 81 Rear lid: button for closing the rear lid.



Fig. 82 On the driver's door: button for opening and closing the rear lid.

Opening the rear lid

- Unlock the vehicle and briefly press the handle of the rear lid. On vehicles with Keyless Access you can directly press the handle of the rear lid. The rear lid is unlocked if an authorised key is recognised in the proximity of the vehicle.

- **EITHER:** pull the ↩ button on the driver door upwards for approx. 1 second »» Fig. 82. The button also works when the ignition is switched off.

- **OR:** press and hold the ↩ button of the vehicle key for approx. 1 second. If the vehicle is locked, only the rear lid is unlocked (the doors remain locked).

- **OR:** on vehicles with Keyless Access and sensor-controlled opening you can open the rear lid by moving one foot in the area of the sensors located below the rear bumper (Easy Open »» page 102). The rear lid will open automatically.

Closing the rear lid

- Briefly press the ↩ button on the rear lid »» Fig. 81, »» ⚠ in Introduction on page 100.

- **OR:** pull up and hold the ↩ button on the driver's door until the rear lid is fully closed »» Fig. 82 (only with the ignition switched on).

- **OR:** on vehicles with Keyless Access, press and hold the ↩ vehicle key button until the rear lid is closed or move one foot in the area of the sensors located below the rear bumper (Easy Open »» page 102). The vehicle key must be in the Keyless Access system detection zone at the rear outside the vehicle.

- **OR:** hold the rear lid by one of the handles fitted to the inner lining and close it by moving it downwards.

- The rear lid lowers automatically to the final position and also locks automatically »» ⚠ in Introduction on page 100.

Interrupting opening or closing

After beginning to open or close the rear lid, the action can be halted by pressing one of the buttons ↩.

If you press one of the ↩ buttons again, the rear lid will move again in the original direction.

If the rear lid meets with resistance or an obstacle during the automatic opening or closing, opening or closing will be interrupted immediately. For the closing process, the rear lid opens again slightly.

- Check why it has not been possible to open or close the rear lid.

- Try to open or close the rear lid again.

- If necessary, the rear lid can be opened or closed by hand using reasonable force.

Particular features if towing a trailer

If the factory-fitted towing bracket is electrically connected to a trailer »» page 294, the electric rear lid can only be opened or closed with the buttons on the rear lid itself or by using the Easy Open function.


Audible warnings

Throughout the process of opening or closing the rear lid, acoustic warnings can be heard. *Exception:* when the rear lid is opened manually using the handle or the Easy Open function with the movement of the foot or closed using the button on the rear lid itself »» Fig. 81.

Modifying and memorising the opening angle

If the space behind or above the vehicle is less than the travel area of the rear lid, you can change the opening angle of the rear lid.

To memorise a new opening angle, the rear lid must be open at least halfway.

- Interrupt the opening process in the desired position.
- Press the  »» Fig. 81 button on the rear lid for at least 3 seconds.

The opening angle is memorised. Memorisation is indicated by blinking of the hazard warning lights and an audible warning.

Resetting and memorising the opening angle

For the rear lid to reopen completely, the opening angle must be reset and memorised again.

- Release the rear lid and open it to the memorised height.
- Lift the rear lid by hand as far as it goes. To do this, some force will have to be used.

- Press the  »» Fig. 81 button on the rear lid for at least 3 seconds.

- This resets and memorises the factory-set opening angle. Memorisation is indicated by blinking of the hazard warning lights and an audible warning.

Automatic protection against overheating

If the system is operated repeatedly in a short space of time, it automatically switches off to prevent overheating.

Once the system is cool again, the function can be reused. Until then, the rear lid can only be opened and closed by hand using reasonable force.

If with the rear lid open the vehicle battery is disconnected »» page 339 or the corresponding fuse burns out »» page 322, the system will have to be reset. This requires closing the rear lid completely once.

Emergency unlocking

»» page 103.

WARNING

If a lot of snow builds up on the rear lid or it is heavily loaded, the rear lid may not open or, after opening, it may lower by itself due to the extra weight and cause serious injury.

- Do not open the rear lid when there is a lot of snow on it or when carrying a load (e.g. on a rack).
- Before opening the rear lid, remove the snow or the load.

Rear lid with sensor-controlled opening and closing (Easy Open)

Valid for: Leon Sportstourer

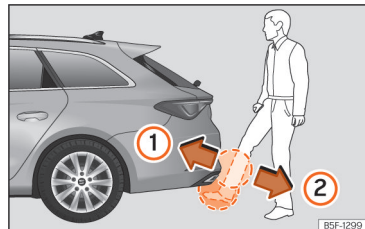


Fig. 83 Rear lid with sensor-controlled opening [Easy Open].

If there is a valid vehicle key in the proximity of the rear lid, it is possible to unlock and open or close it moving one foot in the area of the sensors located under the rear bumper.

- Switch the ignition off.
- Stand in front of the rear bumper, in the middle.
- With a brisk movement, bring your foot and lower leg as close as you can to the bumper. The lower part of the leg needs to be close to the upper sensor area and your foot to the lower sensor area »» Fig. 83 ①.
- Quickly remove your foot and lower leg from the sensor areas »» Fig. 83 ②. The rear lid will open automatically.
- If the rear lid fails to open, repeat the procedure after a few seconds. The detection zone of the lower sensor may not have been reached.

The rear lid can be closed with another foot movement similar to the opening one (provided a valid vehicle key is in the proximity of the rear lid).


When closed, the rear lid automatically locks if the vehicle has been locked beforehand and there is no valid key inside.

While the rear lid is in motion (either opening or closing), it can be stopped with another foot movement similar to the opening one (provided a valid vehicle key is in the proximity of the rear lid).

The Easy Open feature is not available or only has limited availability in the following situations (examples):

- If the rear bumper is very dirty.
- If the rear bumper is wet with salt water, e.g. after having driven on gritted roads.
- If the vehicle has been equipped at a later time with a tow bracket.

In the event of heavy rain, the Easy Open feature may take a little longer to open the boot or may deactivate automatically, to avoid the boot opening by accident, e.g. because of the running water.

The Easy Open function can be connected and disconnected permanently in the infotainment system using the button  > **Vehicle** > **Exterior** > **Central locking**.

WARNING

If there is a valid key in the proximity of the rear lid, in some cases the Easy Open function may be accidentally activated and the rear lid will open, for example, when sweeping under the rear bumper, when directing a water jet or high pressure steam to the area or when carrying out maintenance work or repairs in that area. If accidentally opened, the rear lid could injure somebody situated in its area of operation or cause material damage.

- Therefore, always make sure that there is no unsupervised valid key in the area near the rear lid.
- Before carrying out any maintenance or repair work on the vehicle, always disable the Easy Open feature via the infotainment system.
- Before washing the vehicle, always disable the Easy Open function via the infotainment system.
- Before attaching a bike rack or hitching a trailer »» page 294, always disable the Easy Open function via the infotainment system.

Emergency unlocking of the rear lid

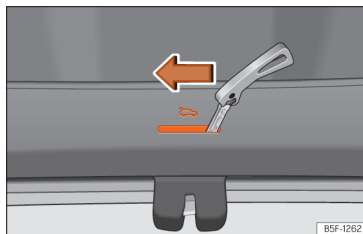


Fig. 84 Luggage compartment: manual release [Leon].



Fig. 85 Luggage compartment: manual release (Leon Sportstourer).

The rear lid can be unlocked from inside in the event of an emergency (e.g. if the 12 volt battery is flat).

There is a groove in the luggage compartment allowing access to the emergency opening mechanism.

Unlocking the rear lid from inside the luggage compartment

- Insert the key blade into the slot and move the key in the direction of the arrow until the lock unlocks >>> **Fig. 84**, >>> **Fig. 85**.

Window controls

Opening and closing the windows

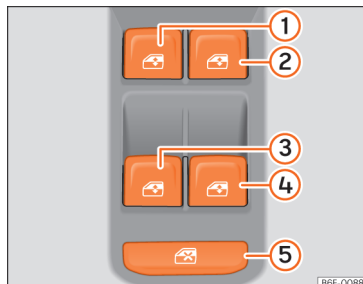


Fig. 86 Detail of the driver's door: window controls.

- Opening the window: press button
- Closing the window: pull button

Buttons on the driver door

- ① Left-hand front door window
- ② Right-hand front door window
- ③ Left-hand rear door window
- ④ Right-hand rear door window
- ⑤ Safety control for deactivating the window control buttons on the rear doors

Both front and rear windows can be operated from the controls on the driver's door. The other doors have a separate control for each window.

Always close the windows completely when the vehicle is parked or out of sight >>> .

You can use the electric windows for approx. 10 minutes after switching off the ignition if neither the driver door nor the front passenger door have been opened and the ignition key has not been removed (depending on the equipment).

Safety switch

The safety control >>> **Fig. 86** ⑤ on the driver door can be used to disable the electric window buttons on the rear doors.

Safety control not pressed: the buttons on the rear doors are activated.

Safety control pressed: the buttons on the rear doors are deactivated.


The safety control symbol lights up in yellow if the buttons on the rear doors are switched off.

Comfort opening and closing



The windows can be opened and closed from the outside using the vehicle key:

Convenience opening:

- Press and hold the button on the remote control key until all the windows and the sunroof have reached the desired position.

• **OR:** First unlock the vehicle using the  button on the remote control key and then keep the key in the driver door lock until all the windows and the sunroof have reached the required position.


Convenience closing:

• Press and hold button  on the remote control key until all the windows and the sunroof are closed >>> .

• **OR:** Keep the key in the driver door in the "lock" position until all the windows and the sunroof are closed.

• **OR:** using the Keyless Access system (only locking): Press and hold the locking sensor surface >>> **Fig. 88** (arrow) on the door handle for several seconds to close the windows and the sunroof. If you stop touching the sensing surface, the locking function is interrupted.

Comfort locking closes the windows first and then the panoramic sunroof.

In the infotainment system different settings can be adjusted using the function button  > **Vehicle > Exterior > Windows > Convenience opening.**

One-touch opening and closing

Automatic raising and lowering fully opens and closes the windows. It is not necessary to press and hold the appropriate window button for this purpose.

For the automatic raising function: pull the button for the corresponding window upwards until it reaches the second position.

For the automatic lowering function: push the button for the corresponding window downwards until it reaches the second position.

Stop automatic movement: push or pull on the button of the corresponding window.


Resetting the automatic raise/lower function

If the 12-volt battery is disconnected or discharged when the windows are not completely closed, the electric window automatic raising and lowering function deactivates and has to be reset:

- Switch the ignition on.
- Close all doors and windows.
- Pull the corresponding window button upwards and hold it in this position for a few seconds.
- Release the button, pull it up again and hold it in this position. This resets the automatic raising and lowering function.

The function can be reset for a single window or for several windows at the same time.

WARNING

Observe the safety warnings >>>  in *Introduction* on page 97.


- **Improper use of the power windows can cause injury.**
- **Never close windows carelessly or in an uncontrolled manner, as this could cause serious injuries to you or third parties. Therefore, make sure that no one is in the way of the moving windows.**
- **If the ignition is switched on, electrical equipment such as the power windows could activate, which can cause injury.**
- **The vehicle's doors can be locked with the remote control key, making it difficult to get help in an emergency.**
- **Therefore always take the key with you when you leave the vehicle.**
- **The power windows are only deactivated when the ignition is switched off and one of the front doors is opened.**
- **If necessary, deactivate the rear power windows with the safety control. Make sure that they have actually been deactivated.**
- **For safety reasons, you should only unlock and lock the vehicle with the remote control key when you are approximately 2 metres away from the vehicle. When pressing the lock button, always monitor the movement of the windows to avoid accidents. Releasing the button immediately interrupts the closing process.**


Note

If the window is not able to close because it is stiff or because of an obstruction, the window will automatically open again >>> page 106. In this case, check why the window could not be closed before trying again.

Window anti-trap function

The roll-back function reduces the risk of injury when the electric windows close.

If a window encounters resistance or an obstacle when closing, it will reopen immediately >>> .


- Check why the window does not close.
- Try closing the window again.
- If the closing process is interrupted again, the anti-trap function stops working for a few seconds.
- If the window still cannot be closed, it will stop in the corresponding position. Pulling the button again within a few seconds closes the window **without the anti-trap function** >>> .

Closing the windows without the anti-trap function

- Try to close the window again by pulling the button without releasing it, within a few seconds. **The anti-trap function will be deactivated!**

- If the closing process takes longer than a few seconds, the anti-trap function is activated again. The window will stop again if it encounters resistance or an obstacle, and will reopen automatically.
- If the window will still not close, visit a specialised workshop.

WARNING

Observe the safety warnings >>>  in *Opening and closing the windows* on page 105.

- **The roll-back function does not prevent fingers or other parts of the body getting pinched against the window frame. Risk of accident.**

Note

The anti-trap function also works when the windows are closed with the comfort function using the vehicle key.

Sunroof**Introduction**

The sunroof only works when the ignition is switched on. Once the ignition has been switched off, you can still open or close the sunroof for a few minutes provided the driver door and the front passenger door are not opened.

WARNING

If the sunroof is used negligently or without paying due attention, it can cause serious injury.

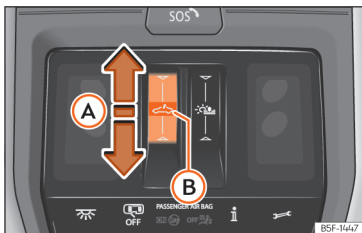
- Open or close the sunroof and the sun blind only when no one is in their path of movement.
- Never leave any key inside the vehicle when exiting.
- Never leave a child or any other person who may need help in the vehicle, especially if they have access to the vehicle key. If using they key unattended, they could lock the vehicle, start the engine, switch on the ignition and activate the sunroof.
- After switching off, it is still possible to open or close the sunroof during a short space of time provided that neither the driver nor passenger door is opened.

NOTICE

- To prevent damage, during winter temperatures remove any ice or snow that might be on the car roof before opening the sunroof or adjusting the tilt position.
- Before leaving the vehicle or in case of rainfall, always close the sunroof. With the sunroof open or in a tilted position, water can enter the interior and can cause considerable damage to the electrical system. As a result, other damage can occur in the vehicle.

Note

- Leaves and other loose objects that accumulate on the sunroof rails should be regularly cleaned away either by hand or with a vacuum.
- If the sunroof does not work correctly, the anti-trap function will not work either. Contact a specialised workshop.

Operating the sunroof**Fig. 87** On the headliner: glass roof button.

The functional area can be operated in two ways: by sliding and pressing.

- Sliding:** The roof is opened or closed totally or partially.
- Pressing:** The roof is raised, opened or closed totally or partially. Press again to stop the automatic movement.

Raising, opening and closing the sunroof

Opening the sunroof:

- Automatic movement: slide your finger back over the functional area **Fig. 87 (A)**.
- Manual movement: slide back over the functional area and hold it there.

Closing the sunroof:

- Automatic movement: slide your finger forward over the functional area **(A)**.
- Manual movement: slide forward over the functional area and hold it there.

Raise the sunroof (it is only possible to raise the sunroof if it is closed):

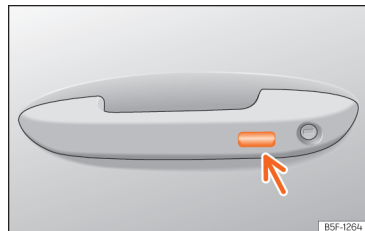
- Automatic movement: press briefly in the centre of the functional area **(B)**.

Closing the sunroof when raised:

- Automatic movement: slide your finger forward over the functional area **(A)**.
- Or** press briefly in the centre of the functional area **(B)**.

Stop the automatic opening or closing movement:

- Press the functional area again **(A)**.

Convenience function to open or close the sunroof**Fig. 88** Door handle: sensor surface.

The sunroof can be opened and closed with the convenience function, just like the windows.

Using the door lock

- Hold the key in the door lock of the driver door in either the unlocking or locking position to open or close the roof in the tilted position. Release the key to interrupt this function.

Using the remote control

- Keep the locking or unlocking button pressed to open or close the roof. If you release the button the opening or closing will stop.

Using the Keyless Access system (only locking)

Press and hold the locking sensor surface »» Fig. 88 (arrow) on the door handle to close the sunroof. If you release the sensor surface, the closing movement stops.

Anti-trap function of the panoramic sunroof

The anti-trap function can reduce the risk of injury when closing the sunroof »» ⚠. If the sunroof encounters resistance or an obstacle when closing, it reopens immediately.

- Check why the sunroof did not close.
- Try to close the sunroof again.
- If the sunroof cannot be closed due to an obstacle or some resistance, it stops at the corresponding position and then reopens. For automatic closing, a new closing attempt might take place.
- If the sunroof is still unable to close, close it without the anti-trap function.

Closing the sunroof without the anti-trap function

- Before approx. 5 seconds after activation of the anti-trap function, slide your finger forward over the functional area ⤴ »» Fig. 87 (A) and keep pressed until the sunroof is fully closed.

- The sunroof closes without the anti-trap function intervening!
- If the sunroof will still not close, visit a specialised workshop.

⚠ WARNING

Closing the sunroof without the anti-trap function can cause serious injuries.

- Always be careful when closing the sunroof.
- No person should ever remain in the way of the sunroof, especially when closing without the anti-trap function.
- The anti-trap function does not prevent fingers or other parts of the body from becoming trapped against the roof frame and injuries occurring.

Glass roof sun blind



Fig. 89 On the headliner: operate the sun blind.

Opening or closing the sun blind

Automatic movement:

- Swipe backwards or forward over the functional area ⤴ »» Fig. 89.

Manual movement:

- Swipe backwards or forward over the functional area ⤴ and press and hold.

Steering wheel

Multifunction steering wheel

Functions

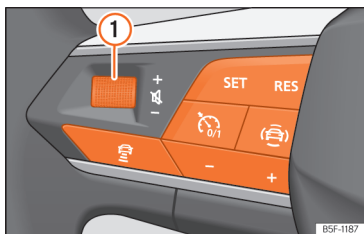


Fig. 90 Controls on the steering wheel.

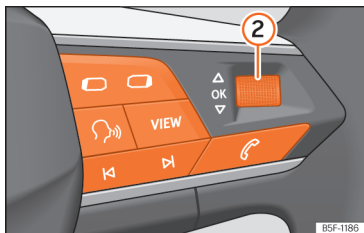












Fig. 91 Controls on the steering wheel.

The steering wheel includes multifunction modules from where it is possible to control the audio, telephone, navigation, voice control and assist functions without the driver needing to be distracted from the road.

Buttons available depending on the version

①	<p><i>Turn:</i> Turn volume up/down. <i>Press:</i> Mute volume.</p>
②	<p><i>Turn:</i> Search in the instrument panel menu. In Navigation mode, turn to zoom in/out of the map on the digital instrument cluster. <i>Press:</i> Select the highlighted option in the instrument cluster</p>
	<p><i>Radio:</i> Search for the previous/next station. <i>Media:</i> Short press: previous/next track; long press: fast forward/rewind.</p>
	<p>Activate phone menu (answer call, end call).</p>
	<p>Switch between media and radio sources.</p>
	<p>Change the instrument panel menu (previous/next).</p>
	<p>Enable/disable voice control.</p>
VIEW	<p><i>Digital instrument cluster:</i> Change digital panel views >>> page 18</p>

	<p>Activate or deactivate steering wheel heating >>> page 139</p>
	<p>Switching ACC on or off >>> page 185 / Cruise control >>> page 181 / Speed limiter >>> page 183 / Travel Assist >>> page 199.</p>
SET	<p>Activate ACC / Travel Assist / Speed limiter</p>
RES	<p>Reset programmed speed.</p>
- +	<p>+ : Increase programmed speed. - : Decrease programmed speed.</p>
	<p>Select Travel Assist / ACC.</p>
	<p>Open the driver assistants menu in the instrument cluster.</p>
	<p>Modify the programmed ACC distance.</p>

Steering wheel position adjustment

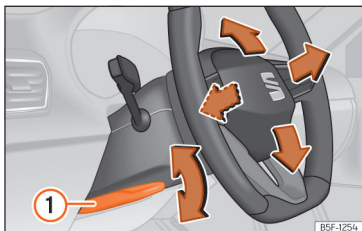


Fig. 92 Lever in the lower left side of the steering column.

Adjust the steering wheel before your trip and only when the vehicle is stationary.

- Pull lever »» Fig. 92 ① down, move the steering wheel to the desired position and lift the lever back up until it locks.

⚠ WARNING

Incorrect use of the steering wheel adjustment function and an incorrect adjustment of the steering wheel can result in severe or fatal injury.

- After adjusting the steering column, push lever »» Fig. 92 ① firmly upwards so that the steering wheel does not accidentally change position while driving.

- Never adjust the steering wheel while the vehicle is in motion. If you need to adjust the steering wheel while the vehicle is in motion, stop safely and make the proper adjustment.
- The adjusted steering wheel should be facing your chest and not your face so as not to hinder the driver's front airbag protection in the event of an accident.
- When driving, always hold the steering wheel with both hands on the outside of the ring at the 9 o'clock and 3 o'clock positions to reduce injuries when the driver's front airbag deploys.
- Never hold the steering wheel at the 12 o'clock position or in any other manner (e.g. in the centre of the steering wheel). In such cases, if the driver's airbag deploys, you may sustain injuries to your arms, hands and head.

Seats and head restraints

Front seats

Introduction

⚠ WARNING

Always read and observe the information and safety advice given in chapter >>> page 42, *Correct sitting position of vehicle occupants*.

⚠ WARNING

Incorrect seat adjustment may lead to accidents and severe injuries.

- Only adjust the seats when the vehicle is stationary, as the seats could move unexpectedly while the vehicle is in motion and you could lose control of the vehicle. Furthermore, an incorrect position is adopted when adjusting the seat.
- Adjust the height, position and inclination of the front seats only when their movement area is empty.
- Make sure there are no objects in that area.
- Make sure that the movement and locking areas of the seats are clean.

⚠ WARNING

Incorrectly using upholstery and seat covers might cause an accidental activation of the electrical seat adjustment system and make it move unexpectedly while driving. This might cause loss of control of the vehicle and thus accidents or injuries. Moreover, the electrical components of the front seats might be damaged.

- Never attach or place seat upholstery or covers on the electric controls.
- Never use upholstery or seat covers that have not been explicitly authorised for the seats of the vehicle.

⚠ NOTICE

Objects with sharp edges can damage the seats.

- Do not rub the seats with sharp objects. Sharp objects, such as zips and rivets on clothing or belts, can damage surfaces. Open Velcro fasteners can also cause damage.

Manual adjustment of the front seats

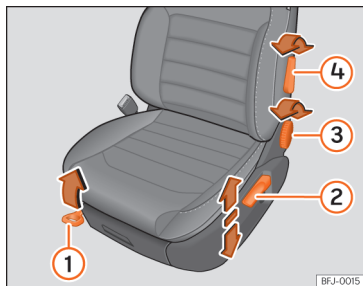


Fig. 93 Front seats: manual seat adjustment.

- 1 Pull the lever to move the seat forwards or backwards. The seat must engage when the lever is released!
- 2 Move the lever up or down to adjust the seat height; several times if necessary.
- 3 Without placing force on the seat backrest, turn the wheel to adjust the backrest.
- 4 To adjust the lumbar support, move the lever until the required position is achieved.

Electric adjustment of the front seats

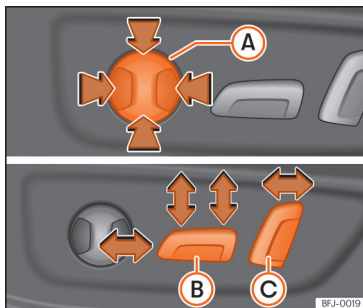


Fig. 94 Driver's seat: electric seat adjustment.

- A** Adjust the lumbar support: press the button according to the desired position.
- B** Seat forwards/backwards: press the button forwards/backwards.
Seat up/down: Press the rear part of the button up/down. To adjust the angle of the seat cushion, press the front of the button up/down.
- C** Backrest further upright/further reclined: press the button forwards/backwards.

The position will be saved automatically in the SEAT Connect Active user when the ignition is switched off¹⁾.

¹⁾ Valid for vehicles fitted with the Infotainment Connect System.

⚠ WARNING

If the electric front seats are used negligently or without paying due attention, it can cause serious injury.

- The front seats can also be electrically adjusted when the ignition is switched off. Never leave a child or any other person who may need help in the vehicle.
- In the event of an emergency, electrical adjustment can be stopped by pressing any control.

ⓘ NOTICE

To avoid damaging the electrical components of the seats, please refrain from kneeling on the seat or applying sharp pressure at a single point to the seat cushion and backrest.

ⓘ Note

- It may not be possible to electrically adjust the seat if the vehicle battery is very low.
- If the engine is started while the seats are being electrically adjusted, the adjustment will stop.

ⓘ Note

When changing user a warning will be shown on the infotainment system's screen during the time that the seat is moving to the saved position. This movement can be stopped by pressing the stop button on the screen.

Rear seats

Folding down and raising the rear seat backrest

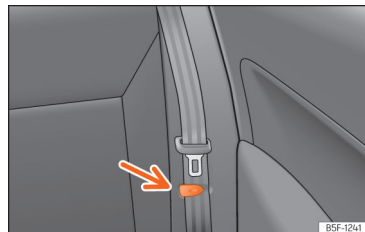


Fig. 95 Rear seat: clip to hold the seatbelt in place.

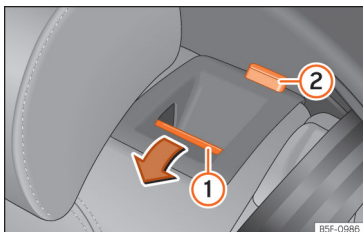


Fig. 96 Rear seat: folding down the backrest.

The rear seat backrest is split and each part be lowered separately to extend the luggage compartment.

Folding the backrest forwards

- Place the side seat belts in the trim clip »» **Fig. 95**.
- Fully lower the rear headrests »» page 114.
- Press the unlock button »» **Fig. 96** ① forwards and at the same time fold the backrest down. The rear seat backrest is not engaged when the red marking of the button ② is visible.

Converting the table to a seat

- Raise and lock in the back rest. The red marking on button ② should no longer be visible when the backrest is properly secured.

⚠ WARNING

Serious injuries can be caused if the rear seat backrest is lowered or lifted without due care and attention.

- Never lower or lift the rear seat backrest while driving.
- Do no trap or damage the seat belt when raising the rear seat backrest.
- When lowering or lifting the rear seat backrest, keep your hands, fingers, feet and other body parts out of its path.
- For the rear seat belts to offer the necessary protection all the parts of the rear backrest must be properly engaged. This is particularly important in the case of the centre rear seat. If someone is seated in a seat whose backrest is not properly engaged they will fly forward, along with the backrest, during an accident or a sudden driving or braking manoeuvre.
- A red mark on button ② warns that the rear backrest is not engaged. Always check that the red marking is not visible when the backrest is in the upright position.
- When the rear seat backrest is lowered or is not properly engaged nobody else can travel in the corresponding seats (not even a child).

ⓘ NOTICE

Serious damage can be caused to the vehicle and other objects if the rear seat backrest is lowered or lifted without due care and attention.

- Before lowering the rear seat backrest, always adjust the front seats so that neither the head restraints nor the cushions of the rear backrest can hit them.

Headrest

Introduction

The possibilities for the adjustment and disassembly of the headrests are described below. Always make sure that the seats are correctly adjusted »» page 42.

All seats are equipped with a head restraint. The central rear headrest is only intended for the central seat of the rear bench. Therefore, do not install it on any other seat.

Correct adjustment of head restraint

Adjust the headrest so that its upper edge is at the same level as the top of your head and under no circumstances below eye level. Keep the back of your head always as close to the head restraint as possible.

Adjusting the head restraint for short people

Lower the head restraint completely, even if your head is below its upper edge. In the lowest position, there may be a small distance between the head restraint and the backrest.

Adjusting the head restraint for tall people

Push the head restraint up as far as it will go.

⚠ WARNING

If travelling with the head restraints removed or improperly adjusted, the risk of severe or fatal injuries in the event of accidents and sudden braking or manoeuvres increases.

- Always travel with the head restraint correctly installed and adjusted.
- To decrease the risk of cervical injuries in the event of an accident, adjust the head restraint correctly based on your height, always making sure that its upper edge is at the same height as the top of the head, but never below eye level. Keep the back of your head always as close to the head restraint as possible and centred.
- Never adjust the head restraint while the vehicle is in motion.
- Under no circumstances should the rear passengers travel while the head restraints are in the non-use position.

ⓘ NOTICE

When assembling and disassembling the head restraints, do not let them meet the top lining of the vehicle, the back rest of the front seat or other parts of the vehicles. If not, this could damage the vehicle.

Adjusting the headrests

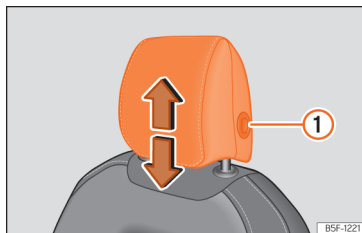


Fig. 97 Front seat: adjusting the head restraint.

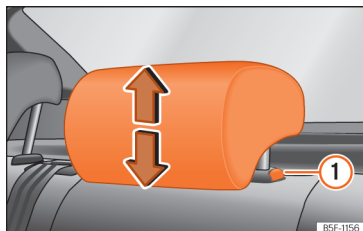


Fig. 98 Rear headrest: adjusting the headrest.

Adjusting the height of the head restraints

- Grab the sides of the head restraints with both hands and push upwards to the desired position. To lower it, repeat the same action, pressing the button on the side **1** >>> **Fig. 97** , >>> **Fig. 98**.
- The headrest must lock correctly in one position.

Removing and fitting the headrests

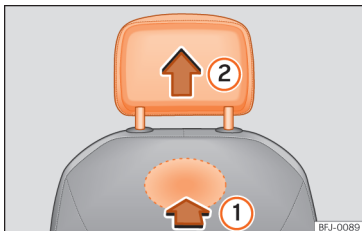


Fig. 99 Front head restraint: removal.

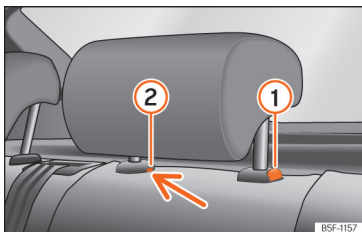


Fig. 100 Rear head restraint: removal.

Removing the front head restraints

- Lower the head restraint if necessary.
- To unlock it, look for the rabbet on the bottom of the backrest and press in the direction of the arrow >>> **Fig. 99 ①**.
- Remove the head restraint in the direction of the arrow **②**.

Fitting the front head restraints

- Place the head restraint in the correct position on the guides of the corresponding backrest and insert it.
- Press the head restraint downwards until the bars lock.
- Adjust the head restraint according to the instructions on the correct position of the seat.

Removing the rear head restraints

To remove the head restraint, the corresponding backrest must be partially folded forward.

- Unlock the backrest >>> **page 112**.
- Move the head restraint upwards until it arrives to the top.
- Press button >>> **Fig. 100 ①**, while simultaneously pressing on the safety hole **②** with a flat screwdriver a maximum of 5 mm wide, and remove the headrest.
- Move the backrest until it engages properly >>> **⚠ in Folding down and raising the rear seat backrest on page 113**.

Fitting the rear head restraints

To mount the external head restraints, the corresponding backrest must be partially folded forward.

- Unlock the backrest >>> **page 112**.
- Insert the head restraint bars into the guides until they perceptibly engage. It should not be possible to remove the head restraint from the backrest.
- Move the backrest until it engages properly >>> **⚠ in Folding down and raising the rear seat backrest on page 113**.

⚠ WARNING

Remove the rear headrests only when it is necessary to fit a child seat. After removing a child seat, refit the headrest immediately.

Seat functions

Memory function

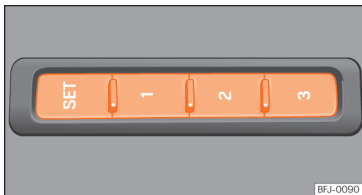


Fig. 101 On the outer side of the driver's seat: memory buttons.

Memory buttons

The memory buttons can be used to save and activate settings for the driver seat and exterior mirrors.

The settings will also be saved in the user of the online services.

Save the settings for the driver seat and exterior mirrors for forward gear

- Apply the electronic parking brake.
- Set the gearbox to the neutral position.
- Switch the ignition on.
- Adjust the driver seat and exterior mirrors.
- Press **SET** for longer than 1 second >>> **Fig. 101**.

- Press the memory button in which to store the settings within approx. 10 seconds. An audible signal confirms that they have been saved.

Save the settings of the front passenger exterior mirrors for reversing.

- Apply the electronic parking brake.
- Set the gearbox to the neutral position.
- Switch the ignition on.
- Press whichever memory button you want.
- Select reverse gear.
- Adjust the front passenger exterior mirror so that you can see, for example, the kerb edge well.
- The set position for the mirrors is automatically saved and assigned to the key with which you unlocked the vehicle.

Activating the settings

- With the vehicle stopped and the ignition switched on, press and hold the corresponding memory button until the saved position is reached.
- **OR:** With the ignition switched off and the driver's door open, briefly press the corresponding button.

The front passenger side exterior mirror automatically changes from the position stored for reversing as soon as the vehicle moves forward

at a speed of at least 15 km/h (10 mph) or when the gear selection lever is changed to a position other than **R** >>> page 130.

Initialising the seat position memory

If, for example, the driver seat has been replaced, the position memory system must be restarted.

Restarting deletes all memories and assignments of seats with memory functions. The memory keys can then be programmed again.

- Open the driver's door and do not get into the vehicle.
- Change the seat settings from outside.
- Tilt the backrest fully forward.
- Release the control to adjust the inclination and press it again until an audible signal sounds.

WARNING

Only set the memory function when the vehicle is stationary.

Note

If the driver door is opened approx. 10 minutes after the vehicle was unlocked or later, the driver seat and the exterior mirrors do not move automatically.

Front centre armrest

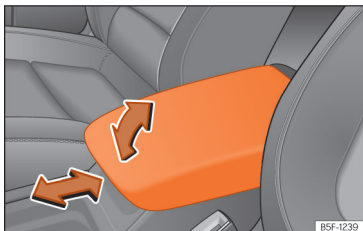


Fig. 102 Front centre armrest

To raise the armrest, pull it fully up in the direction of the arrow »» Fig. 102 up or step by step depending on the desired opening.

To lower the armrest, first lift it to its highest position. Then lower it down.

To move the armrest horizontally, move it forward »» Fig. 102 or backward as much as possible in the direction of the corresponding arrow.

⚠ WARNING

The front centre armrest may obstruct the driver's arm movements, which could cause an accident and severe injuries.

- Keep the storage compartments of the centre armrest closed at all times while the vehicle is in motion.

- Never let anyone sit on the centre armrest while the vehicle is in motion, not even a child. This position is incorrect and may cause severe injuries.

Unlock the seat backrest with the cord.

✓ Valid for: LEON Sportstourer

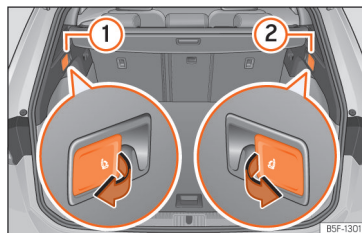


Fig. 103 In the luggage compartment: levers to unlock the rear backrest.

- Lower the head restraint properly.
- Open the rear lid.
- Pull the remote release lever of the left »» Fig. 103 ① or right ② parts of the backrest in the direction of the arrow. The released part of the rear seat backrest is folded automatically down and forwards.
- If this occurs, close the rear lid.

The rear backrest is not engaged when a red mark can be seen on the button »» Fig. 96 ②.

Lights

Vehicle lighting

Indicator lamps



Lights up yellow

There is a total or partial failure of the exterior lighting.



Lights up yellow

Rear fog light on.



Lights up green

Left or right turn signal. The control lamp flashes twice as fast when a turn signal is faulty.

Hazard warning lights on >>> page 69.



Lights up green

Trailer turn signals.



Lights up blue Main beam on or flasher activated >>> page 120.



Lights up blue

The Light Assist system is on >>> page 121.

Lighting and visibility buttons




Fig. 104 Instrument panel: light panel.

By pressing the button  you can select between (the corresponding indicator lights up):

 Switching on the dipped beam headlights.

AUTO Automatic control of dipped beam and daytime running light.

 Switching on the side lights. The automatic headlight control **AUTO** activates at over a speed of approx. 10 km/h (6 mph).

- Lights off. Automatic headlight control **AUTO** activates at a speed of over approx. 10 km/h (6 mph) or after travelling 100 m (approx. 328 ft).


Additionally, the following light functions can be activated by pressing on the corresponding symbol.

When the function is activated, the corresponding symbol lights up. To deactivate it, you will need to press on the symbol again.



Turning the front fog lights on or off.



Turning the rear fog lights on or off. In addition, the control lamp on the instrument cluster lights up .




Switching the windscreen demisting function on and off >>> page 135.



Switching the rear window heating on and off >>> page 135.

The driver is personally responsible for the correct use and adjustment of the lights in all situations.

Side lights

When the side light  is switched on, the side lights in both headlights, certain areas of the rear light clusters, the number plate light and the button lights on the instrument cluster turn on. The automatic dipped beam activates as of a speed of approx. 10 km/h (6 mph).

Automatic dipped beam headlight control **AUTO**

When the automatic dipped beam is switched on, the vehicle's lighting and the lighting of the instruments and controls turn on and off under the following conditions:

- The light sensor has detected darkness.
- The wiper has been on for some time.

When the lights are on, the control lamp lights up in yellow.

The automatic dipped beam is only an auxiliary function and cannot always identify all situations that may arise during driving with sufficient precision.

If the vehicle has the appropriate equipment, the vehicle settings menu of the infotainment system can be used to set the moment that the dipped beam automatically switches on >>> page 38.

Cornering light function

The *cornering* light function is an additional function to the dipped beam headlights to improve lighting of the side of the road when taking a sharp turn at low speed.

When the dipped beam is on, a static cornering light comes on when driving at speeds below about 40 km/h (25 mph) or on very tight bends.

- If the steering wheel is turned or the turn signal is switched on, the front fog light gradually turns on. After the turn, the *cornering* light function is gradually switched off.
- When engaging reverse gear, both front fog lights turn on.

Daytime running lights

Daytime running lights can increase the vehicle's visibility when driving in daylight and they turn on automatically when the ignition is switched on (if brightness is detected).

Motorway light

The motorway light is available on vehicles fitted with LED High lights.

The function is connected and disconnected via the corresponding Infotainment system menu.

- **Activation:** when going above 110 km/h (68 mph) for more than 10 seconds, the dipped beam raises slightly to increase the driver's visibility distance.
- **Deactivation:** when reducing the speed of the vehicle below 100 km/h (62 mph), the dipped beam immediately returns to its normal position.

Audible warnings to advise the driver that the lights have not been switched off

If the ignition is not connected and the driver door is open, an audible warning signal is heard in the following cases: this will remind you to turn the light off.

- When the parking light is on >>> page 120.
- When the lamp ⌂ or Q is on.

If the exit lighting is switched on ("Coming Home" function), when you leave the vehicle there will be no audio warning to warn you that the lights are still on.

WARNING

If the road is not well lit and other road users cannot see the vehicle well enough or at all, accidents may occur.

- **The automatic dipped beam control (AUTO) only switches on the dipped beam when there are no changes in brightness, and not, for example when it is foggy.**

WARNING

The side lights or daytime running lights are not bright enough to illuminate the road ahead and to ensure that other road users are able to see you.

- **Always use your dipped beam head lights if it is raining or if visibility is poor.**
- **Never drive with daytime lights if the road is not well lit due to weather or lighting conditions.**

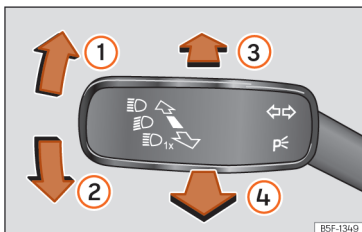
WARNING

If the headlights are set too high and not used correctly, there is a risk of dazzling or distracting other road users. This could result in a serious accident.

- **Always make sure that the headlights are correctly adjusted.**

Note

- The legal requirements regarding the use of vehicle lights in each country must be observed.
- The dipped beam headlights will only work with the ignition on. The side lights come on automatically when the ignition is turned off.
- The rear fog light can dazzle drivers behind you. You should use the rear fog light only when visibility is very poor.
- When the lights are off or in position **AUTO** or $\rightarrow\leftarrow$ and the fog lights are switched on, the dipped beam is also switched on regardless of the ambient brightness.

Turn signal and main beam lever**Fig. 105** Turn signal and main beam lever.

Move the lever to the required position:

- 1 Right turn light or right-hand parking light (ignition switched off).

- 2 Left turn light or left-hand parking light (ignition switched off).
- 3 Turning on the main beam. The control lamp H lights up on the instrument cluster.
- 4 The headlight flasher turns on when the lever is pulled. The control lamp H lights up on the instrument cluster.

Place the lever in rest position to turn off the corresponding function.

Convenience turn signals

When the ignition is switched on, move the lever as far as possible upwards or downwards and release the lever. The turn signal will flash three times.

To switch off the convenience turn signal early, immediately move the lever in the opposite direction until you feel resistance and release it.

The convenience turn signals can be activated and deactivated in the infotainment system, in the vehicle settings menu \gg page 38.

Parking light P

The parking lights will only work with the ignition off. If said light is on, an audible warning will sound while the driver door is open.

- Switch the ignition off.
- Move the turn signal lever up or down.

When the parking light is switched on, the front side light and the tail light on the corresponding side of the vehicle turn on.

Parking light on both sides

- Switch the ignition off.
- Press the button H to select $\rightarrow\leftarrow$.
- Lock the vehicle from the outside.

When this is done, only the side lights of both headlights, along with the tail lights, partially light up.

WARNING

Using turn signals inappropriately, not using them or forgetting to turn them off can confuse other road users. This could cause an accident with serious consequences.

- Always give warning of lane changes, overtaking or turning manoeuvres by activating the turn signals well in advance.
- As soon as the lane change, overtaking or turning manoeuvre is complete, switch off the turn signal.

WARNING


Improper use of the main beam can cause accidents and serious injuries, as it can distract and dazzle other drivers.

 Note


- When you turn the ignition off without having turned the turn signals off, an acoustic signal sounds while the driver door is open. It is intended to remind you to turn off the turn signals, unless you want to leave the parking light on.
- If the convenience turn signals are on (three flashes) and the convenience turn signal on the opposite side is activated, the active side stops flashing and only flashes once on the newly selected side.
- The turn signal only works when the ignition is switched on. The turn signals only work when the ignition is switched on.
- The *main beam* can only be switched on when the dipped beam is switched on.
- If a trailer turn signal fails, the indicator light (trailer turn signals) stops flashing, instead of flashing the turn signal at double speed in the vehicle.
- In cold or wet weather conditions, the headlights, tail lights and turn signals may be temporarily fogged from the inside. This is normal and has no effect on the service life of the vehicle's lighting system.
- The parking light does not activate automatically if the left- or right-hand turn signal is left on and the ignition is disconnected.



Main beam assist (Light Assist)

The main beam assist automatically prevents glare from vehicles moving in the opposite direction or ahead in the same direction. In addition, the main beam assist detects illuminated areas and disconnects the main beam headlight when passing, e.g. by populated areas.


Within its limitations, the assist system automatically connects or disconnects the main beam headlight depending on the environmental and traffic conditions, as well as the speed >>> .

Switching on the main beam assist

- Switch on the ignition and select mode **AUTO** on the headlight control >>> **Fig. 104**.
- From the base position, press the turn signal and main beam headlights lever forwards >>> **Fig. 105** .

When the main beam assist is switched on, the control lamp  on the instrument cluster screen turns on. When the main beam is on, the blue main beam control lamp  on the instrument cluster switches on.

Switching the main beam assist off

- Switching off mode **AUTO** on the headlight control >>> **Fig. 104**.
- **EITHER:** if main beam assist is on, pull the turn signal light and main beam headlights lever back >>> **Fig. 105** .

- **OR:** if the main beam assistant is on, but the main beam **does not** turn on, press the turn signal and main beam lever forwards to turn the main beam on manually. Pull the turn signal and main beam lever back to switch off the main beam manually, if necessary.
- **OR:** switch off the ignition.

System limitations

In the following cases, the main beam headlight must be switched off manually because the main beam assist will not disconnect it on time or disconnect it at all:

- On insufficiently lit roads with highly reflective signs.
- If road users are insufficiently lit up, e.g. pedestrians or cyclists.
- On closed curves, when the traffic in the opposite direction is partially hidden, on pronounced slopes or inclinations.
- On roads with traffic in the opposite direction and with a central reservation barrier where the driver can see over it e.g. lorry drivers.
- In case of fog, snow or heavy rainfall.
- In case of swirling dust or sand.
- If the windscreen is damaged in the camera's field of vision.
- If the camera's field of vision is misted up, dirty or covered by a sticker, snow or ice.
- If the camera is damaged or if the power supply has been cut off.

⚠ WARNING

The comfort features of the main beam assist must not lead you to take any risks. The system is not a replacement for driver concentration.

- You must always control the main beam yourself and adapt it to the light, visibility and traffic conditions.
- The main beam regulator may not recognise all driving situations correctly and may operate with limitations in certain circumstances.
- When the camera's field of view is dirty, covered or damaged, the operation of the main beam regulator may be affected. This also applies when the vehicle's lighting installation is modified, e.g. when additional headlamps are installed.

! NOTICE

To avoid affecting the operation of the system, take the following points into consideration:

- Clean the field of vision of the camera regularly and make sure it is free of snow and ice.
- Do not cover the field of vision of the camera.
- Check that the windscreen is not damaged in the area of the camera's field of view.

i Note

- The headlight flasher can be turned on and off manually at any time with the turn signal and main beam lever >>> page 120.
- If there are objects that radiate light in the camera's area of influence, e.g. a portable navigation system, this may affect the operation of the main beam assist system.

“Coming home” and “Leaving home” function (exterior orientation lighting)

The “Coming home” and “Leaving home” function lights up the vehicle's immediate surroundings when getting into and out of it in the dark.

This light is automatically controlled by a light sensor.

Turning on the “Leaving home” light

- Unlocks the vehicle (if the automatic dipped beam function **AUTO** is switched on and the light sensor detects darkness).

Turning off the “Leaving home” light

- It turns off automatically once the lights off delay time has elapsed.
- **OR:** lock the vehicle.

- **OR:** press the light control as many times as necessary until the instrument cluster displays the setting **OFF**.

- **OR:** switch on the ignition.

Turning on the “Coming home” light

- Switch the ignition off.

The “Coming home” light comes on if the automatic headlight control **AUTO** is switched on and the light sensor detects darkness.

The lights-off delay countdown starts when the last door or rear lid of the vehicle is closed.

Turning off the “Coming home” light

- It switches off automatically after the set lights-off delay time has elapsed.
- **EITHER:** it is automatically deactivated if, 30 seconds after the function has been activated, any vehicle door or the rear lid is still open.
- **OR:** press the light control as many times as necessary until the instrument cluster displays the setting **OFF**.
- **OR:** switch on the ignition.

“Coming home” and “Leaving home” settings

The duration of the lights-off delay can be set in the vehicle settings menu of the infotainment system, where the function can also be activated and deactivated >>> page 38.

Headlight range control


Dynamic headlight range control (valid for vehicles fitted with High headlights)

The headlight range is automatically adjusted according to the vehicle load status when they are switched on.

Manual headlight range adjustment (valid for vehicles fitted with ECO Led headlights)

The headlight range control adapts the dipped headlight beam to the vehicle's loading conditions. This means that the driver has optimum visibility conditions without dazzling oncoming vehicles.

The range of the headlights can be adjusted in the Infotainment System »» page 38

- Select  > **Vehicle** > **Lights** to open the **Headlight range adjustment** menu.
- Select the appropriate level for the vehicle loading conditions.

Levels:

- 0 Two front occupants and luggage compartment empty.
- 1 All seats occupied and luggage compartment empty.
- 2 All seats occupied, luggage compartment full.
- 3 Driver's seat occupied and luggage compartment full.

WARNING

If the dynamic headlight range control fails or does not work properly, the headlights could dazzle and distract other road users. This could cause accidents and lead to serious injuries.

- Immediately go to a specialist workshop and have the headlight range control system checked.

Driving abroad

The light beam of the dipped beam lights is asymmetric: the side of the road on which you are driving is lit more intensely.

When a car that is manufactured in a country that drives on the right travels to a country that drives on the left (or vice versa), it is normally necessary to cover part of the headlight bulbs with stickers or to change the adjustment of the headlights to avoid dazzling other drivers.

In such cases, the regulations specify certain light values that must be complied with for designated points of the light distribution. This is known as "Tourist light".

The light distribution of the headlights allows the specific "tourist light" values to be met without the need for stickers or changes being made to the settings.

Note

"Tourist light" is only allowed temporarily. If you are planning a long stay in a country that drives on the other side, you should take the vehicle to an Authorised Technical Service to change the headlights.

Interior lights

Lighting of the instrument cluster, displays and controls

The instrument and control lighting brightness can be set in the vehicle settings menu of the infotainment system »» page 38.

The set intensity automatically adapts to changes in ambient brightness in the vehicle.

When the automatic dipped beam light **AUTO** is turned on, a sensor automatically turns the dipped beam light on or off, as well as the instrument and control lighting, depending on the ambient brightness.


In some cases, e.g. when driving through a tunnel without the automatic dipped beam light **AUTO** function switched on, the instrument cluster lighting may even switch off. The objective of this function is to provide the driver with a visual indication that he or she should activate the dipped beam. If your vehicle is fitted with a digital instrument cluster, the message **Turn on the lights** will be displayed on the instrument cluster.

Interior and reading lights




Fig. 106 Detail of headliner: front interior lighting.

 Turning the interior lights on or off.

 **OFF** Door contact connection. The interior lights come on automatically when you unlock the vehicle, open a door or disconnect the ignition. The light goes out a few seconds after closing all the doors, when locking the vehicle or connecting the ignition.

Reading light


The reading light is tactile, each lens is turned on and off individually by pressing in the respective central area. In addition, the intensity of the light can be adjusted according to the pressure exerted.

If you want to turn on the two lenses together you must press the symbol  **Fig. 106**.

Glove compartment and luggage compartment lighting

When opening and closing the glove compartment on the front passenger side and the rear lid, the respective light will automatically switch on and off.

Footwell lighting

The lights in the footwell area below the dash (driver and front passenger sides) will switch on when the doors are opened and will decrease in brightness while driving. This brightness can be adjusted through the infotainment system menu using the function button  >

Background lighting >>> page 38.

Note

The reading lights go out when the vehicle is closed and locked or after a few minutes of turning the ignition off. This prevents the battery from discharging.

Background lighting



Background lighting provides lighting in different areas of the interior.

There are predefined versions of **Ambient Light** >>> **Fig. 107**.

The intensity of the lighting can be adjusted using the function button .

Drive profile Lights up the interior of the vehicle depending on the selected drive profile.

Individual To adjust the intensity of the background lighting in each of the areas as well as to change the colour in the versions that have lighting on the front door panel and the instrument panel line.

Off Turns off the background lighting.

Additional functions of the background lighting




- **Door open alert:** Representation on the line of the respective front door if the vehicle reaches 10 km/h while either of the two front doors is not closed properly.
- **Rear windows locked alert:** Representation on the line of the respective front door when the operation buttons of the rear windows are pressed, if they have been locked with the safety button  >>> **page 104** and the vehicle is locked (Auto Lock).
- **Representation of the hazard warning lights:** Animation on the entire background lighting line while the hazard warning light function is active.

Fig. 107 Schematic diagram: Background lighting.

The representation of these functions by the background lighting can be switched on and off both individually and as a whole in the infotainment system:  > **Background lighting** >  **Settings**.

Note

In some versions, the colour indicated on the infotainment screen may not match the actual colour of the vehicle's interior lighting.

Visibility

Windscreen wiper and rear window wiper systems

Window washer lever

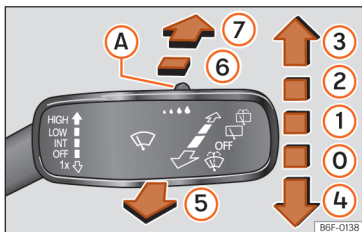


Fig. 108 Operation of windscreen wipers and rear window wiper system.

More the lever to the required position:

OFF ① Windscreen wipers off.

INT ① Intermittent wiping of the windscreen activates the rain sensor. The intermittent wiping of the windscreen depends on the speed at which you are driving. The faster the speed, the more frequent the wiping.

LOW ② Slow wipe.

HIGH ③ Fast wipe.

1x ④ Short wipe. Pressing the lever for longer accelerates the wiping.

⑤ Pull the lever to switch on the automatic windscreen washer/wiper. The Climatronic switches on air recirculation for approx. 30 seconds to prevent the smell of windscreen washer fluid from entering the vehicle interior.

⑥ Switches on the intermittent rear window wipe. The wiper operates at intervals of approx. 6 seconds.

⑦ Pressing and holding the lever turns on the automatic rear window washer/wiper.

A Control for adjusting the duration of the wiping intervals (vehicles without rain and light sensors) or the sensitivity of the rain sensor.

⚠ WARNING

If insufficient antifreeze is added to the washer fluid, it could freeze on the glass and impair visibility.

- Do not use the wiper system in winter temperatures without first heating the windscreen with the heating and ventilation system. Windscreen washer fluid could freeze on the windscreen and impair forward visibility.

⚠ WARNING

The use of worn or dirty wiper blades reduces visibility and increases the risk of serious accidents and injuries.

- Replace the wiper blades whenever they are in poor condition or worn out and no longer clean the windows sufficiently
- » page 314.

ⓘ NOTICE

Before driving off and before switching on the ignition, check the following aspects of the wiper blades and the wiper motor to prevent damage to the glass:

- The wiper lever is in the neutral position.
- You have removed or cleared any snow and ice from the wiper blades and windows.
- You have carefully removed any wiper blades that may have frozen from the window. SEAT recommends an de-icer spray for this purpose.

ⓘ NOTICE

Do not turn on the wiper until the glass is dry. Using the wipers while dry can damage the glass.

Note

- When the vehicle stops while the wiper is on, the wiper switches to operating temporarily at the next lower wiping level.
- If the driver or passenger door is opened when the vehicle is stationary, the wipers return to the starting position and are switched off. If the door is closed or the wiper lever is moved within a few seconds, the wiper turns on again.
- In winter, the service position of the wipers can be useful to make it easier to lift the wipers off the windscreen when the vehicle is going to be left stationary >>> page 314.

Wiper functions

Automatic rear window wipe

The rear wiper switches on automatically when the wiper is switched on and reverse gear is engaged. The automatic rear window wiper activation when engaging reverse gear can be activated and deactivated in the infotainment system, in the vehicle settings menu >>> page 38.

Note

The windscreen will be wiped again approximately 5 seconds after the windscreen washer has been activated, provided the vehicle is moving ("drip" function). If you activate the wipers less than 10 seconds after the "drip" function, a new wash sequence will

begin without performing the last wipe. For the "drip" function to work again, you have to turn the ignition off and then on again.

Note

The wiper will try to wipe away any obstacles that are on the windscreen. The wiper will stop moving if the obstacle is still blocking its path. Remove the obstacle and switch on the wiper again.

Rain and light sensor

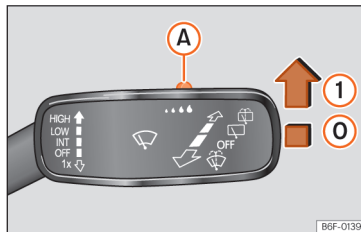


Fig. 109 Windscreen wipers lever: adjust the rain sensor (A).

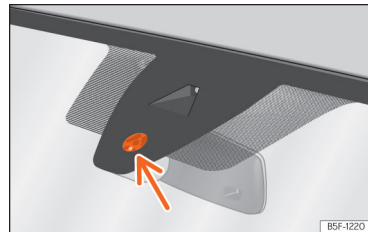


Fig. 110 Sensitive surface of the rain sensor.

The rain sensor controls the frequency of the windscreen wiper intervals, depending on the amount of rain >>> ⚠.

Push the lever to the desired position >>> Fig. 109.

- Rain sensor deactivated.
- ① Rain sensor active; automatic wiping if necessary.
- Ⓐ Setting sensitivity level of rain sensor:
 - Set control to the right: high sensitivity.
 - Set control to the left: low sensitivity.

When the ignition is switched off and then back on, the rain sensor stays on and starts operating again when the windscreen wipers are in position >>> Fig. 109 ① and the vehicle is travelling at more than 16 km/h [10 mph].

Abnormal operation of the rain and light sensor

The possible causes of anomalies and erroneous interpretations *in the sensitive surface area*

»» **Fig. 110** of the rain sensor are, among others:

- **Damaged wipers:** a film of water on the damaged blades may lengthen the activation time, reduce the washing intervals or result in a fast and continuous wipe.
- **Insects:** the impact of insects may cause the wiper to activate.
- **Salt on the road:** in winter, salt spread on the roads may cause an excessively long wipe when the windscreen is almost dry.
- **Dirt:** dry dust, wax, coating on glass (Lotus effect) or traces of detergent (car wash) may reduce the effectiveness of the rain sensor or make it react more slowly, later or not at all. Regularly clean the sensitive surface of the rain sensor »» **Fig. 110** (arrow) and check for possible damage to the wiper blades.
- **Windscreen crack:** the impact of a stone will trigger a single wipe cycle with the rain sensor on. The rain sensor then detects the reduction of the sensor surface and adjusts itself. The behaviour of the sensor may vary depending on the size of the stone impact.

WARNING

The rain sensor may not detect rain sufficiently and may not activate the windscreen wipers.

- If necessary, switch on the windscreen wipers manually when water hinders the view through the windscreen.

Note

- The use of an alcohol-based glass cleaner is recommended to remove waxes and coatings.
- Do not put stickers on the windscreen in front of the rain sensor. This can cause alterations or failures.

Mirrors

General safety instructions

The exterior and interior mirrors allow the driver to observe vehicles driving behind and adapt his or her driving behaviour accordingly.

For safe driving, it is important for the driver to adjust the exterior mirrors and interior mirror correctly before setting off.

When looking through the exterior mirrors and the interior mirror, it is not possible to see the entire area behind and to the sides of the vehi-

cle. These areas outside the field of view are known as the blind spot. Other road users and objects may be in the blind spot.

WARNING

Adjusting the exterior mirrors and interior mirror while driving can distract the driver. This could cause accidents and lead to serious injuries

- Only adjust the exterior mirrors and interior mirror when the vehicle is stationary.
- When parking, changing lanes, overtaking or turning, always keep a close eye on your surroundings, as other road users or objects may also be in the blind spot.
- Always make sure that the mirrors are adjusted correctly and that visibility to the rear is not reduced by ice, snow, fogging or other objects.

WARNING

A failure to accurately estimate the distance to vehicles driving behind can lead to serious accidents and injuries.

- Curved (convex or aspherical) mirrors increase the field of view and objects in them appear smaller and further away.
- Curved mirrors do not allow you to precisely calculate the distance to vehicles driving behind, so using them when changing lanes could cause serious accidents and injuries.

- If possible, use the interior mirror to precisely calculate the distance to vehicles driving behind you, or to other objects.
- Always make sure you have sufficient visibility to the rear.

⚠ WARNING

The automatic anti-dazzle mirrors contain an electrolyte fluid which could leak if the mirror is broken.

- If it gets out, the electrolyte fluid can irritate the skin, eyes and respiratory organs, particularly in the case of people with asthma or similar diseases. Immediately inhale enough fresh air and get out of the vehicle, or open all windows and doors if this is not possible.
- If the electrolytic fluid comes into contact with your eyes or skin, immediately rinse the affected area with plenty of water for at least 15 minutes and seek medical advice.
- If the fluid comes into contact with footwear or clothing, rinse immediately with plenty of water for at least 15 minutes. Clean thoroughly before using the footwear or clothing in question again.
- If the electrolytic fluid is swallowed, immediately rinse the mouth with plenty of water for at least 15 minutes. Do not induce vomiting unless advised by a doctor. Immediately seek medical attention.

ⓘ NOTICE

Electrolyte fluid may leak if the automatic anti-dazzle mirror is broken. This liquid attacks plastic surfaces. Therefore, it should be cleaned as fast as possible with a damp sponge or similar.

Interior mirror

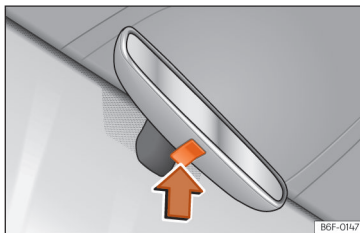


Fig. 111 Manual anti-dazzle function for rear vision mirror

Manual anti-dazzle function for interior rear vision mirror

- To darken the rear view mirror, press the mirror button updates >>> **Fig. 111** (arrow).
- To return to the basic position, press the back of the button.

Rear view mirror with automatic anti-dazzle function

When the ignition is switched on, the sensors in the mirror measure the light falling on it from behind and in front.

The interior mirror automatically darkens based on the measured values.

If the light falling onto the sensors is blocked or interrupted, e.g. by a sunshade blind or hanging objects, the automatic anti-dazzle interior mirror does not work or does not work properly. Similarly, the use of portable navigation devices attached to the windscreen or close to the automatic anti-dazzle interior mirror can affect the operation of the sensors >>> ⚠.

The automatic anti-dazzle function is deactivated in certain situations, e.g. when reverse gear is engaged.

⚠ WARNING

Light from screens of portable navigation devices can cause malfunctions of the automatic anti-dazzle interior mirror and may cause serious accidents and injuries.

- Abnormal operation of the automatic anti-dazzle function may result in it being impossible to use the interior mirror to precisely calculate the distance to vehicles driving behind, or to other objects.

Adjusting the exterior mirrors

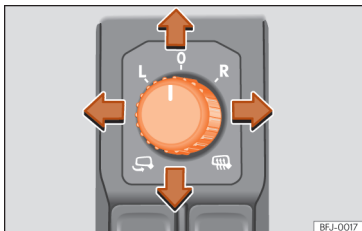





Fig. 112 Detail of the driver door: control for the exterior mirror.

Turn the control to the corresponding position.

L/R Moving the control to the desired position adjusts the mirrors on the driver's side (**L**, left) and on the passenger's side (**R**, right) in the desired direction.

 Depending on the equipment fitted on the vehicle, the mirrors may be heated according to the outside temperature.

 Folding the mirrors ››› .

0 The exterior mirror cannot be adjusted and all functions are deactivated.

Activating exterior mirror functions


The following exterior mirror functions can be activated and deactivated in the vehicle settings menu of the infotainment system ››› page 38.

Synchronized regulation of the exterior mirrors

The synchronised mirror setting simultaneously adjusts the right hand exterior mirror when the left mirror is adjusted

- Turn the control to position **L**¹⁾.
- Adjust the left-hand exterior mirror. The right exterior mirror will be adjusted at the same time (synchronised).
- If necessary, correct the setting of the right hand mirror: turn the control to position **R**¹⁾.

Fold the rearview mirrors when locking the vehicle

When the vehicle is locked or unlocked from the outside, the exterior mirrors can be folded in or out automatically, depending on the equipment. For this purpose, the rotary control has to be in position , **L**, **R**, or **0**.


If the rotary control of the electric exterior mirrors is in the folded position, the exterior mirrors remain folded.

Memory function

The memory buttons ››› page 116 can be used to save and turn on settings for the exterior mirrors.

The settings will also be saved in the user of the online services.

Saving the passenger rear view mirror settings for reversing

- Switch the ignition on.
- In the infotainment system, select  > **Vehicle** > **Exterior** > **Mirrors** ››› page 38.
- Select the **R**¹⁾ position on the control.
- Select reverse gear.
- Adjust the front passenger exterior mirror so that you can see, for example, the kerb area well.
- Release the reverse gear.
- The adjusted position for the rear view mirror is stored.

Activating the passenger side exterior mirror settings for reversing

- Turn the exterior mirror control knob to position **R**¹⁾.
- Engage reverse gear with the ignition switched on. The right-hand exterior rear-view mirror will move to the saved position.

¹⁾ Regulation in right-hand drive vehicles is symmetrical

The passenger side exterior mirror leaves the saved reversing position when the vehicle is travelling faster than approx. 15 km/h (9 mph), or if the control is turned from position **R** to another position.

⚠ WARNING

Fold and unfold the exterior mirror, taking care to avoid injuries.

- Only fold or unfold the exterior mirror when there is no-one in the way of the mirror.
- When moving the mirror, take care not to trap fingers between the mirror and the mirror bracket.

⚠ NOTICE

- Before washing the vehicle in an automatic car wash, please make sure to fold the exterior mirrors in to prevent them from being damaged.
- The electrically folding exterior mirrors must only be operated electrically, not by hand, and this could damage their electric drive.

🌿 For the sake of the environment

Do not leave the exterior mirror heating on for longer than necessary. Otherwise it causes unnecessary energy consumption.

📘 Note

If the electrical adjustment should fail to operate, both of the mirrors can be adjusted by hand by lightly pressing the edge of the mirror glass.

Sun protection

Sun blind

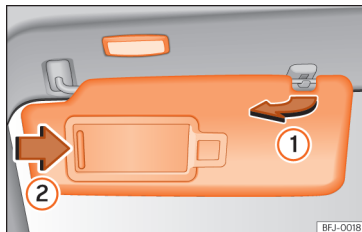


Fig. 113 Sun visor

Options for adjusting driver and front passenger sun visors

- Lower the sun visor towards the windscreen.
- The sun visor can be pulled out of its mounting and turned towards the door »» Fig. 113 ①.
- Swing the sun visor towards the door, longitudinally backwards.

There is a vanity mirror on the sun visor, with a cover. When the cover is opened ② a light comes on.

The lamp goes out when the vanity mirror cover is closed or the sun visor is pushed back up.

⚠ WARNING

Folded sun blinds can reduce visibility.

- Always store sun blinds and visors in their housing when not in use.

📘 Note

The light above the sun visor automatically switches off after a few minutes in certain conditions. This prevents the battery from discharging.

Air conditioning



Heating, ventilation and cooling

Introduction

Depending on the vehicle equipment, the air conditioning systems can be:

- **Climatronic of 1 zone:** heats, ventilates, cools and dehumidifies the passenger compartment considering it as a single air conditioning area.
- **The 3 zone climatronic:** heats, ventilates, cools and dehumidifies the passenger compartment considering it as 3 independent air conditioning areas (driver, front passenger and rear seats).

There are several ways to switch on the air conditioning:

- Press  in the air conditioning menu
»» page 135.
- **OR:** Press  in the air conditioning menu
»» page 135 or on the light control
»» page 118.
- **OR:** Change the desired temperature.
- **OR:** Press **AUTO**.

Some functions and menu tabs depend on the equipment.

Economic use of the air conditioning

Extra fuel (combustion engines) or electricity (hybrid in electric mode) may be consumed by the compressor while the air conditioning is on.

The air conditioning operates most effectively with the windows and the sunroof closed. However, if the passenger compartment has heated up after standing in the sun for some time, the air inside can be cooled more quickly by briefly opening the windows and the sunroof.

Operating the air conditioning with voice commands

Depending on the equipment, some of the air conditioning functions can be operated by voice control »» page 260.

Passenger recognition function¹⁾

The front and rear zone passenger recognition function turns down the air conditioning in these areas if no occupation is detected in them, with the aim of reducing the vehicle's energy consumption.

When the ignition is switched on, the vehicle recognises whether a person is sitting in one of its seats.

The turning down of the air conditioning is indicated as follows:

- **Front passenger area:** on the front passenger temperature setting, which will display **ECO** instead of the selected temperature.
- **Rear area:** On the rear temperature setting, where **ECO** will be displayed instead of the selected temperature. This turning down of the air conditioning will also be displayed on the control located in the rear area.

Air conditioning percentage reached function

Shows how long it will take to reach the set comfort temperature as a percentage.

Once reached, 100% will be displayed on the screen. There is one indicator for the driver's area and another for the passenger area.

Dust and pollen filter

The dust and pollen filter with its activated charcoal cartridge serves as a barrier against impurities in the air taken into the vehicle interior.

The dust and pollen filter must be changed regularly so that air conditioner performance is not adversely affected.

¹⁾ Valid for hybrid vehicles.

If the filter loses efficiency prematurely due to use in areas with very high levels of air pollution, the filter must be changed more frequently than stated in the Service Schedule.

Air vents

To ensure proper heating, cooling and ventilation in the vehicle interior, the air vents must remain open.

There are other additional, non-adjustable air vents in the instrument panel, in the footwells and in the rear area of the passenger compartment.

WARNING

Reduced visibility through the windows increases the risk of serious accidents.

- Always ensure that all windows are free of ice and snow, and that they are not fogged, so as to maintain good visibility of everything outside.
- Only drive when you have good visibility.
- Always ensure that you use the air conditioner and heated rear window to maintain good visibility.
- Never leave the air recirculation on for a long period of time. If the cooling system is switched off and air recirculation mode switched on, the windows can mist over very quickly, considerably limiting visibility.
- Switch air recirculation mode off when it is not required.

NOTICE

Food, medicines and other objects sensitive to heat or cold may be damaged or made unsuitable for use by the air coming from the vents.

- Never place food, medicines or other temperature-sensitive objects close to the air vents.

Note

- When the cooling system is turned off, air coming from the outside will not be dried. To prevent fogging of the windows, SEAT recommends leaving the cooling system turned on. To do this, press the function button **A/C**. The icon should light up.
- The maximum heat output required to defrost windows as quickly as possible is only available when the engine has reached its normal running temperature.
- Keep the air intake slots in front of the windscreen free of snow, ice and leaves to ensure heating and cooling are not impaired, and to prevent the windows from misting over.
- The air from the vents flows through the vehicle interior and is extracted by slots in the luggage compartment designed for this purpose. Therefore, you should avoid obstructing these slots with any kind of object.

- It is advisable to turn on the air conditioning at least once a month, to lubricate the system gaskets and prevent leaks. If a decrease in the cooling capacity is detected, a Technical Service should be consulted to check the system.

- When the engine is under extreme strain, switch off the compressor for a moment.

Climatronic control




Fig. 114 Schematic representation: air-conditioning functions.

A Climabar


Fixed bar at the top of the Infotainment System screen >>> **Fig. 114 A** (even if it is off) where the following Air Conditioning functions are located:

CLIMA By pressing it, you can access the Air conditioning menu >>> **page 135**.

 Access the seat heating submenu >>> **page 137**.

Temperature Sliding your finger from left to right or vice versa over the numbers sets the desired temperature on the corresponding side. Press on the same numbers to access the temperature adjustment submenu.

OR: use the touch zones **1** and **2** (blue / red) to adjust the temperature of the Air Conditioning >>> **Fig. 114**.

 Switching air recirculation on and off >>> **page 136**.

Temperature setting submenu

+/- Press to set the desired temperature on the driver or front passenger side. You can also slide your finger over the bar to make the adjustment.

SYNC *Only for versions with 3-zone Climatronic.* Synchronizes the temperature on the driver's side with the other zones.

Air Conditioning Menu

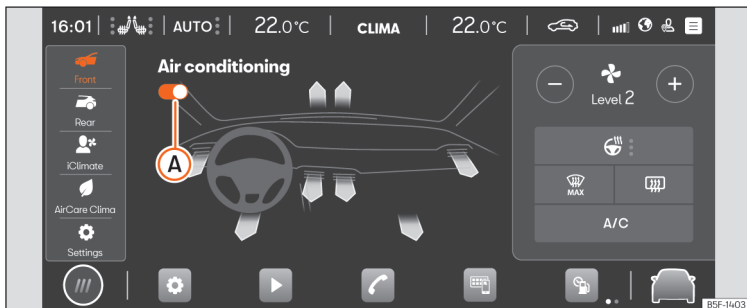


Fig. 115 Schematic diagram: Air conditioning menu.

Within the Air Conditioning menu, the following submenus are found depending on the equipment:

Front Submenu

Submenu for the air conditioning in the front of the passenger compartment where the following functions are found:

- Switching the Climatronic off/on
»» Fig. 115 A.

Vents Press the arrows displayed on the air vents to select the distribution of air towards one or more of the following zones: feet, upper body or windscreen. The colour represented by the arrows does not indi-

cate the outlet temperature of the air, but the requested temperature depending on the surrounding conditions.

In the 1-zone Climatronic versions, it is selected by pressing on the desired distribution icon.

- Manual adjustment of fan speed by pressing \oplus or \ominus .
- Manual steering wheel heating setting with three heating levels. Press the function button repeatedly to achieve the desired level. To disconnect it, press several times until no LED is on »» page 139.
- The defrost/demist function of the Climatronic removes ice and condensation from the windscreen. The air is dehumidified and the fan is set high.

When this function is switched on, the rear air conditioning remains switched off.


- Switches the heated window on or off when the engine is running. It switches off automatically after a maximum of 10 minutes. It should be switched off as soon as the glass is demisted. By saving electrical power you can also save fuel. To avoid possible damage to the battery, an automatic temporary disconnection of this function is possible, coming back on when normal operating conditions are re-established.


A/C Switching the cooling and demisting system on/off.


AUTO In this mode, the system automatically regulates the interior temperature, fan speed and air distribution for optimal thermal comfort. The **AUTO** mode will deactivate as soon as manual changes are made to the fan speed, air distribution, windscreen demisting or air recirculation. Fan speed in **AUTO** mode can be set in the Climaprofile (*low, medium or high*) by successively pressing the function button **AUTO**. Climaprofile adjustment is also possible in the Settings submenu.

Rear Submenu

Submenu for the air conditioning in the rear of the passenger compartment where the following functions are found:

 Connect/disconnect the Climatronic A.


 With the icon lit up, it is not possible to adjust the temperature from the rear area.


 Press to adjust the rear zone temperature.


iClimate submenu


Only for versions with 3-zone Climatronic.


Submenu where different smart and/or automatic functionalities are located, depending on the version.


 Warm hands: automatically adjusts for a certain time the air conditioning to heat the steering wheel area.

 Cool feet: automatically adjusts for a certain time the air conditioning to cool the footwell area.

 Defog the windows: automatically adjusts for a certain time the air conditioning to defog the windscreen.

 Warm feet: automatically adjusts for a certain time the air conditioning to heat the footwell area.

 Fresh Air: automatically adjusts for a certain time the air conditioning to ventilate the passenger compartment.



 Fast cooling: automatically adjusts the air conditioning to ventilate the vehicle interior for a certain amount of time.

AirCare Climate submenu

Only for versions with 3-zone Climatronic.



The air conditioning system contains a filter that can reduce allergen contaminants.

When the Air Care function is activated, the recirculation mode is on and the air is regulated automatically and continuously, as long as there is no detection of fogging hazard.

- Press  to switch the AirCare function on/off.
- Press  to access information about the AirCare system function.

Settings submenu

Submenu where the following settings are located:

- Climaprofile: To adjust the fan speed (*low, medium or high*) during operation in **AUTO** mode.
- Smart heated seat: Pressing  turns the smart heated seats function on/off for the driver and front passenger  **page 137**.

Rear controls

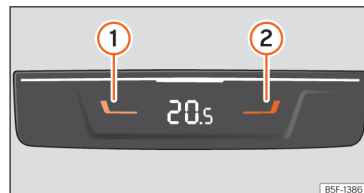



Fig. 116 In the centre console, rear section: controls for the rear seats.


Temperature selection

- Press buttons  and   **Fig. 116** to adjust the temperature of the rear zone.


Air recirculation

 Air recirculation mode prevents the ambient air from entering the interior.

When the outside temperature is very high, you can select air recirculation for a short period of time to refresh the vehicle interior more quickly.

For safety reasons, air recirculation is disconnected when  is pressed or when a sensor detects that the vehicle's windows may mist up.

Switching air recirculation on and off

- Press the  button to switch air recirculation on or off.

WARNING

Stuffiness or used air will increase fatigue and reduce driver concentration possibly resulting in a serious accident.

- **Never leave the fresh air fan turned off or use the air recirculation for long periods of time; the air in the vehicle interior will not be refreshed.**

NOTICE

In vehicles with an air conditioner, do not smoke when air recirculation is switched on. The smoke may be deposited on the cooling evaporator and on the active combination filter and cause permanent unpleasant odours.



Note



When the outside temperature is very high, briefly switching on the air recirculation mode helps to cool the vehicle interior more quickly.

Seat heating

The front seats have three levels of electric heating.

Control seat heating

Press the  icon on the Climabar **>>> Fig. 114**  to open the seat heating menu.

- Press the left or right seat icon to connect the seat heating to maximum power.
- Press the left or right seat icon repeatedly until the desired level is adjusted.
- To switch off seat heating, press the corresponding seat icon several times until no LED is on.
- You can also adjust the seat heating level by using **two** fingers to press the sensor field **>>> Fig. 114**  or  (left or right seat).

If the ignition is switched on again in approx. the next 10 minutes, the driver seat heating is automatically turned on to the level set the last time.

Smart heated seat

This is an smart function that automatically activates and regulates the driver and front passenger seat heating for greater comfort.

The seat heating for the driver's seat and front passenger seat can be adjusted separately to achieve fully personalised comfort.

To access the smart heated seats function, the SEAT CONNECT personalisation service must first be activated **>>> page 239**.

- To switch the function on/off, go to the sub-menu **Settings > Use of the driver/front passenger smart heated seats**.

The smart heated seats function requires a period for learning usage habits. Information about the start of the learning process is shown in the seat heating submenu on the Infotainment display. During this process, the status **LEARNING** will be displayed, and its evolution will also be shown by a progress bar.

Seat heating level 3 (maximum) needs to be used to ensure that habits are learned correctly.

During the learning period, it is advisable to use the seat heater at different outside temperatures to achieve optimum performance of the smart heated seats.

The system will not learn about the use of the seat heating if it is used straight after using the seat heating with stationary air conditioning¹⁾.

Once the learning period is over, the heated seats are turned on and their temperature level adjusted automatically. The status **AUTO** is displayed in the seat heating submenu.

¹⁾ Only valid for hybrid vehicles (extended stationary air conditioning).

To optimise the temperature provided by the system during automatic adjustment (AUTO), manually set the three seat heating levels to optimise the function. The optimisation process will be displayed in the seats submenu of the infotainment display (Optimizing).

To reset the process and start the learning period, go to the submenu **Settings > Reset driver / front passenger profile**.

Cases in which the heat seating should not be switched on

Do not switch the seat heating on if any of the following conditions are met:

- The seat is occupied by a person with limited perception of pain or temperature.
- The seat is not occupied.
- The seat has a cover.
- A child seat has been installed on the seat.
- The seat cushion is wet or damp.
- The outdoor or indoor temperature is greater than +25°C (77°F).

WARNING

People who cannot perceive pain or temperature because of medications, paralysis or chronic diseases (e.g. diabetes) or have a limited perception of these, may suffer burns to the back, buttocks or legs when using seat heating.

- People with limited pain and temperature thresholds must never use seat heating.
- If an abnormality in the device's temperature control is detected, have it checked by a specialist workshop.

WARNING

If the fabric of the cushion is wet, this can adversely affect the operation of the seat heating, increasing the risk of burns.

- Make sure the seat cushion is dry prior to using the seat heater.
- Do not sit on the seat with clothing that is wet or damp.
- Do not leave clothing that is wet or damp on the seat.
- Do not spill liquids on the seat.

NOTICE

- To avoid damaging the heating elements of the seat heaters, please do not kneel on the seat or apply sharp pressure to a single point on the seat cushion or backrest.
- Liquids, sharp objects and insulating materials (e.g. covers or child seats) can damage the seat heating.
- In the event of smells, switch off the seat heating immediately and have it inspected by a specialised workshop.
- If the original seat upholstery is replaced by another material, the seat heating may overheat or its operation may be limited.

For the sake of the environment

The seat heating should remain on only when needed. Otherwise, it is unnecessary energy consumption.

Note

Please note the following for the smart heated seats feature:

- The system may reset the learning process if it has not been satisfactory.
- Separate driver's seat learning will be required for each registered user.
- The passenger seat learns regardless of the active registered user.

● In hybrid vehicles the use of the stationary air conditioning function with electricity consumers >>> page 144 may affect the learning time of the function.

Steering wheel heating

The selected steering wheel heating level will be displayed on the instrument cluster display and in the air conditioning menu.

Adjust the steering wheel heating by pressing on the multifunction steering wheel


- Short press (less than 1 second):

The heating is switched on at its maximum level. Press the steering wheel button repeatedly to set the desired level. To switch off steering wheel heating, press the steering wheel button repeatedly until the heated steering wheel OFF icon is displayed on the instrument cluster.

- Long press (more than 1 second):

The heating is switched off directly from the current operating level. Another long press on the button switches on the heating directly at the last level saved before switching off.

Adjusting the steering wheel heating via the infotainment system

- In the air conditioning menu, press the steering wheel heating function button . The heating is switched on at its maximum level.

- Press the function button repeatedly to set the desired level.
- To switch off steering wheel heating, press the function button several times until no LED is on.

Automatic disconnection

The steering wheel heating will be switched off automatically when any of the following conditions are met:

- Electrical energy consumption is too high.
- The steering wheel heating system is faulty.
- If the ignition is switched off.

Parking ventilation

With the parking ventilation function, the passenger compartment can be ventilated.

The power required for parking ventilation will be provided by the vehicle's 12V battery.

The ventilation function is controlled through the SEAT CONNECT mobile App or the MySEAT website.

Connecting parking ventilation

The function will be switched on as follows:

- The parking ventilation function can be switched on immediately using the immediate on/off button.
- By programming a departure time.

In the event of low level charge of the 12V battery, the parking ventilation will not turn on.

Disconnecting parking ventilation

The parking ventilation will turn off in the following situations:

- When the operating time selected by the user for the immediate on/off mode has elapsed.
- The parking ventilation function will be turned on through the immediate power button on that App.
- When the scheduled departure time has been reached.

The maximum operating period of the parking ventilation is 60 min.

Programming a departure/trip start

The activation of the parking ventilation for a scheduled time is only valid for a single ventilation process. The departure time must be for each newly programmed ventilation process.

Before programming the departure time, you must check that the date and time of the car are correctly set.

When programming a departure time, the car automatically calculates, depending on the environmental conditions, the necessary operating time of the parking ventilation.

NOTICE

Foods sensitive to heat or cold, medications and other objects can be damaged by the airflow.

- Do not place any type of food, medicines or other temperature sensitive items in front of the ventilation slots.

Note

If parking ventilation works repeatedly for long periods of time, the 12V battery charge level will drop. It is advisable to take the vehicle for a long drive to recharge the battery.


Troubleshooting**The cooling system cannot be switched on or its operation is limited**

If the air conditioning system cannot be switched on, this may be caused by the following:

- The engine is not running.
- The fan is switched off.
- The air conditioner fuse has blown.
- The outside temperature is lower than approximately 0°C (+32°F).

- The air conditioner compressor has been temporarily switched off because the engine coolant temperature is too high.
- Another fault in the vehicle. Have the air conditioner checked by a specialised workshop.

Change the temperature unit (Climatronic)

The temperature display can be changed from Celsius to Fahrenheit on the Infotainment system screen using the function button  > **Settings** > **Units**.

Water or water vapour under the vehicle

If the humidity and temperature outside the vehicle are high, **condensation** can drip off the evaporator in the cooling system and form a pool underneath the vehicle. This is normal and does not indicate a leak!

When the outside humidity is high and the ambient temperature is low, condensation water may evaporate when the stationary air conditioning is operating. In this case, steam may be released from underneath the vehicle. This does not mean that the vehicle has any damage.

Note

After starting the engine, any residual humidity in the air conditioner could mist over the windscreen. Switch on the defrost function as soon as possible to clear the windscreen of condensation.

Auxiliary heating (additional heating)**Introduction**

The auxiliary heater runs on fuel from the vehicle's tank and can be used while you are driving and when the vehicle is stationary.

The auxiliary heating can be controlled through the auxiliary heating menu in the Infotainment system, through the SEAT CONNECT mobile app, the MySEAT website or with the remote control.

In winter, with the auxiliary heater switched on, you can defog the windscreen and leave it free of ice and snow (if it is a thin layer) before you start driving.

If the outside temperature is very high, the vehicle interior can be ventilated with the engine off using the auxiliary heater.

The maximum operating period of the parking ventilation is 60 min.

⚠ WARNING

The auxiliary heater exhaust fumes contain carbon monoxide, an odourless and colourless toxic gas. Carbon monoxide can cause people to lose consciousness. It can also cause death.

- Never switch on the auxiliary heater or leave it running in enclosed spaces or areas with no ventilation.
- Never programme the auxiliary heater so that it switches itself on and is running in an enclosed space or an area with no ventilation.

⚠ WARNING

The components of the auxiliary heater are extremely hot and could cause a fire.

- Always park your vehicle so that no part of the exhaust system can come in contact with easily flammable materials that might be below the vehicle, such as dried grass.



ⓘ NOTICE

Never place food, medicines or other temperature-sensitive objects close to the air vents. Food, medicines and other objects sensitive to heat or cold may be damaged or made unsuitable for use by the air coming from the vents.

Switching the auxiliary heater on and off


Connection


The independent heating can be connected in the following ways:

- Press the immediate on/off button in the App or on the MySEAT website.
- Press the immediate on/off button  in the infotainment system (while the vehicle is switched off).
- Press button  on the remote control **>>> page 141**.
- Automatically scheduling a departure time in the auxiliary heater menu in the infotainment system, or on the MySEAT App or website **>>> page 143**.

Disconnection

The independent heating can be switched off in the following ways:

- The supplementary heating function will be turned off immediately using the on/off button in the App or MySEAT website.
- Press the immediate on/off icon  in the infotainment system (while the vehicle is switched off).
- Press button **OFF** on the remote control **>>> page 141**.

- Automatically at the scheduled departure time or after the programmed operating time has elapsed.
- Automatically when the control lamp  (fuel level indicator) lights up.
- Automatically when the 12-volt battery charge drops too low **>>> page 337**.

Things to note


Once switched off, the auxiliary heater will continue to operate for a short period of time in order to burn the fuel remaining in the system and also to expel the exhaust fumes.

Radio-operated remote control



Fig. 117 Independent heating: radiofrequency remote control key

>>> Fig. 117

-  Switch the auxiliary heater on
- OFF** Switch the auxiliary heater off

① Control lamp

If the buttons of the remote control are pressed unnecessarily, it could switch on the auxiliary heater involuntarily, even when it is out of range or when the control lamp is flashing.

To switch on and off the independent heating, the button must be pressed and held for approximately 1 second.

Control lamp on the remote control

When the buttons are pressed, the control lamp on the remote control ① provides the user with different information:

It lights up for approx. 2 seconds

- *In green:* The auxiliary heater has been switched on using the **ON** button.
- *In red:* The auxiliary heater has been switched off using the **OFF** button.

Flashes slowly for approx. 2 seconds

- *In green:* No on signal has been received. The remote control is out of range. Move closer to the vehicle.
- *In red:* No off signal has been received. The remote control is out of range. Move closer to the vehicle.

Flashes quickly approx. 2 seconds

- *In green:* The independent heating is blocked. Possible causes: the fuel tank is almost empty, the 12-volt battery charge is very low or there is a fault.

It lights up for approx. 2 seconds

- *In orange (then in green or in red):* The remote control battery is almost flat. However, the on or off signal has been received.
- *In orange (then flashes green or red):* The remote control battery is almost flat. No on or off signal has been received.

Flashes for around 5 seconds

- *In orange:* The remote control battery is flat. No on or off signal has been received.

Changing the battery of the radio-operated remote control

When pressing the buttons, if the control lamp of the remote ① flashes for approx. 5 orange or does not light up, the batteries must be replaced.

The battery is located beneath a cover on the back of the remote control.

- To open the cover, lift it slightly at the bottom and slide it down.
- Remove the old battery.
- Insert the new battery. When doing so, take into account the polarity and use batteries of the same type » ①.
- Replace the battery cover by inserting the tabs at the top and pressing the bottom.

Range

The receiver is inside the vehicle. The remote control, when fitted with new batteries, has a range of several hundred metres. Obstacles between the remote control and the vehicle, bad weather conditions and discharged batteries can considerably reduce the range of the remote control.

WARNING

Swallowing a battery with a 20 mm diameter or any other button battery can cause serious and even fatal injuries within a very short time.

- Always keep the remote control, keyrings with batteries, the spare batteries, button batteries and all other batteries over 20 mm out of reach of children.
- If you suspect that someone may have swallowed a battery, seek immediate medical attention.

NOTICE

- The radio frequency remote control contains electronic components. Therefore, avoid getting it wet and exposing it to knocks or direct sunlight.
- The use of inappropriate batteries may damage the radio frequency remote control. For this reason, always replace the used battery with another of the same voltage, size and specifications.

For the sake of the environment

- Please dispose of your used batteries correctly and with respect for the environment.
- The remote control battery may contain perchlorate. Observe the legal provisions regarding disposal.
- Care should be taken so as not to operate the remote control unintentionally so as to prevent the auxiliary heater being switched on accidentally.

Programming the auxiliary heater

The activation of the parking ventilation for a scheduled time is only valid for a single ventilation process. The departure time must be for each newly programmed ventilation process.

Before programming the departure time, you must check that the date and time of the vehicle are correctly set.

When programming a departure time, the vehicle automatically calculates, depending on the environmental conditions, the necessary operating time of the parking ventilation.

WARNING

Never programme the auxiliary heater so that it switches itself on and is running in an enclosed space or an area with no ventilation. The auxiliary heater exhaust fumes contain carbon monoxide, an odourless and colourless toxic gas. Carbon monoxide can cause people to lose consciousness. It can also cause death.


Usage instructions

The auxiliary heater exhaust system located below the vehicle must be kept clear of snow, mud and other objects. The exhaust fumes must be able to exit freely. The emissions generated by the auxiliary heater are removed via an exhaust pipe fitted underneath the vehicle.

On heating the vehicle interior, depending on the outside temperature, the warm air is first directed at the windscreen and then to the rest of the vehicle interior through the air vents. Directing the vents – towards the windows for example – can affect air distribution.

When the auxiliary heater is not switched on

- The auxiliary heater requires about as much power as the dipped beam headlights. If the 12-volt battery charge is too low, the auxiliary heater switches off automatically and cannot be switched on. This avoids problems when starting the engine.

- The heating must be activated every time you want to set off. Similarly, the departure time must reactivate each time.
- The control lamp  (fuel level indicator) lights up.

Note

- Noises will be heard while the auxiliary heater is running.
- When the air humidity is high and the inside temperature low, condensation from the heating and ventilating system may evaporate when the auxiliary heater is switched on. In this case, steam may be released from underneath the vehicle. This does not mean that there is a vehicle malfunction.
- If the vehicle is tilted, e.g. if parked on a slope, the operation of the auxiliary heater may be restricted if the fuel tank level is low [just above the reserve level].
- If the auxiliary heater is used a number of times for a long period of time, the 12-volt battery will lose its charge. To recharge the battery, the vehicle must be driven for a number of kilometres from time to time. As a guideline: the journey should last approximately as long as the heater was connected.
- At temperatures below +5 °C (+41 °F), the auxiliary heater may switch itself on automatically when the engine is switched on. The auxiliary heater is switched off again after a certain time.

Stationary air conditioning

Introduction

✓ Valid for: hybrid vehicles.

With the stationary air conditioning you can cool, ventilate and heat the passenger compartment while the vehicle is parked. In winter, you can also demist the windscreen and leave it free of ice and snow (if the layer is thin).

The stationary air conditioning is powered through a socket or the vehicle's high voltage battery. Stationary air conditioning can be programmed and controlled in the Infotainment system, through the SEAT CONNECT mobile App and on the MySEAT website.

You can find information about the app, its availability and the necessary requirements for its use, as well as compatible terminals, on the Internet »» page 237.

NOTICE

Never place food, medicines or other temperature-sensitive objects close to the air vents. Food, medicines and other objects sensitive to heat or cold may be damaged or made unsuitable for use by the air coming from the vents.

Note

Using the stationary air conditioning without connecting the charging cable reduces the vehicle's range. At extreme exterior temperatures, the heating or cooling power of the stationary air conditioning may be insufficient to reach the desired temperature.

Managing the stationary air conditioning

✓ Valid for: hybrid vehicles.

The stationary air conditioning only works if the high voltage battery is sufficiently charged.

The stationary air conditioning can operate when the charging connector is not plugged in. When the charging connector is not plugged in, the stationary air conditioning is powered by the high-voltage battery.


- Open the **Battery Manager** menu.
- Select the **Settings** menu.
- Turn on the **Enable High-Voltage Battery Power** function if necessary.

Setting the desired temperature

- Open the infotainment system's **Battery manager** menu.
- Set the desired temperature using ⊕ and ⊖


Managing the stationary air conditioning

It can be switched on in the following ways:

- Press the immediate on icon  in the Infotainment system (while the vehicle is switched off). During immediate air conditioning, the vehicle reaches the set temperature in a maximum of 30 minutes.
- Press the immediate on/off button in the mobile App or on the MySEAT website.
- Automatically programming a departure time in the mobile App, on the My SEAT website, or in the **Battery Manager** menu of the Infotainment system »» page 145.

Managing the stationary air conditioning

It can be switched off in the following ways:

- Press the immediate on/off button in the mobile App or on the MySEAT website.
- Press the immediate on/off icon  in the infotainment system (while the vehicle is switched off). It is only possible to switch it off if the stationary air conditioning was switched on using this button.
- Press the air conditioning off button in the **Air conditioning** menu of the infotainment system (while the vehicle is off).
- Automatically, a few minutes after the scheduled departure time.
- Automatically if the charge level of the vehicle's high-voltage battery drops excessively.

Note

- Noises will be heard while the stationary air conditioning is running.
- When the outside humidity is high and the ambient temperature is low, condensation from the air conditioning system may evaporate when the stationary air conditioning is running. In this case, steam may be released from underneath the vehicle. This does not mean that there is a vehicle malfunction.

Programming the stationary air conditioning

✓ Valid for: hybrid vehicles.

The stationary air conditioning can be programmed in the Infotainment system for a scheduled departure time. You can set the desired temperature of the vehicle interior for the vehicle's planned departure time.

Based on the desired temperature, the vehicle calculates the time that the stationary air conditioning needs to be switched on to reach this temperature by the departure time.

Air conditioning the vehicle for departure

- Open the **Battery Manager** menu.
- Set the scheduled departure time.
- Turn on the **air conditioning** and **charging** functions as needed.

If the two **air conditioning** and **charging** functions are on at the same time, the high-voltage battery is charged first and then the vehicle is air conditioned. The departure time can only be enabled when one of the two functions has been enabled.

If the charging connector is plugged in, the vehicle starts cooling down around 30 minutes before the scheduled departure time. If the vehicle is not ready to drive at the scheduled departure time, it will be cooled for a further 15 minutes.

If the charging connector is not plugged in, the air conditioning operating time is reduced to 10 minutes. The operating time is extended by 5 minutes if the vehicle is not ready to drive.

The stationary air conditioning switches off automatically.

Extended stationary air conditioning

In the **Battery Manager** menu can be found an option to add extended air conditioning. This means if the vehicle is air conditioned (either by being switched on immediately or due to departure scheduling), the convenience consumers, e.g. seat or rear window heating may switch on automatically if considered necessary by the Climatronic (in cold conditions).

If the air conditioning is switched on immediately, the electrical convenience consumers are also activated.

Comfort consumers depend on features.

- Open the **Battery Manager** menu.
- Tap on the icon of the seats whose convenience consumers you want to switch on in addition to the stationary air conditioning (the driver's seat icon includes the convenience, seat heating and steering wheel heating consumers).
- To turn on the rear window heating before the departure time, switch on the **Automatic rear window heating** function.

The maximum waiting time for comfort consumers is approximately 10 minutes before the departure time.

Immediate activation of the rear window heating

The rear window heating can be switched on/off using the SEAT CONNECT mobile app or the MySEAT website, regardless of whether or not the stationary air conditioning is switched on.

Air-conditioning the vehicle after unlocking it

- Open the infotainment system's **Battery manager** menu.
- Press **Settings**.
- Enable the **When unlocking the vehicle** function.


Checking the programming

When the ignition is switched off, the infotainment system displays the next time that is active and the set functions.

Driving

Driving indications

Pedals

- Ensure that you can always press the accelerator, brake and clutch pedals unimpaired to the floor.
- Ensure that the pedals can return unimpaired to their initial positions.
- Ensure that the floor mats are securely fastened during the trip and do not obstruct the pedals >>> .

Only use floor mats which leave the pedals clear and which are secured to prevent them from slipping. You can obtain suitable floor mats from a specialised dealership. Fasteners for floor mats are fitted in the footwells.

Wear suitable footwear

Always wear shoes which support your feet properly and give you a good feeling for the pedals.

WARNING

- Restricting pedal operation can lead to critical situations while driving.
- Never lay or fit floor mats or other floor coverings over the original floor mats. This would reduce the pedal area and could obstruct the pedals. Risk of accident.
- Never place objects in the driver footwell. An object could move into the pedal area and impair pedal operation.

Selecting the optimal gear

Depending on the equipment on the instrument panel screen, a recommendation is shown with the gear that should be engaged to optimise consumption.

On vehicles with *automatic transmission*, it is only displayed when driving in Tiptronic mode >>> page 165.

No recommendation will appear if the optimal gear is engaged. The current gear will be displayed.

Display	Meaning
3	Optimum gear.
4 ▶ 5	Changing to a higher gear is recommended.
2 ▶ 1	Changing to a lower gear is recommended.

Information regarding the “cleanliness” of the particulate filter

When the exhaust system detects that the particulate filter is close to saturation, this system's self-cleaning function recommends the optimal gear for that function >>> page 311.

WARNING

The gear change recommendation is an auxiliary function and in no case should be a substitute for careful driving.

- Responsibility for selecting the correct gear, depending on the circumstances, rests solely with the driver.

For the sake of the environment

Selecting the correct gear can help to save fuel.

Note

The recommended gear display turns off when you are no longer in tiptronic mode.

Economical and environmentally friendly driving

Fuel consumption, environmental pollution and wear to the engine, brakes and tyres all depend largely on driving style. Consumption can be reduced between 10-15% with an efficient driv-

ing type. The following section gives you some tips on lessening the impact on the environment and reducing your operating costs at the same time.

Active cylinder management (ACT®)

Depending on vehicle equipment, the active cylinder management (ACT®) may deactivate some of the engine cylinders if the driving situation does not require too much power. The number of active cylinders can be seen on the instrument panel display »» page 18.

Foresight when driving

If you think ahead when driving, you will need to brake less and thus accelerate less. Take advantage of the inertia of the vehicle whenever possible, with a **gear engaged**. This takes advantage of the engine braking effect, reducing wear on the brakes and tyres. Emissions and fuel consumption will drop to zero.

Changing gear to save energy

An effective way of saving is to change *in advance* to a higher gear.

Manual gearbox: change from first to second gear as soon as possible. Choosing the correct gear saves fuel. Select the highest possible gear suitable for the driving situation (the engine should continue to run with cyclical regularity).

Automatic transmission: accelerate gradually and without reaching the “kick-down” position.

Avoid driving at high speed

Avoid travelling at your vehicle’s top speed, whenever possible. Fuel consumption, emission of harmful gases and noise pollution multiply as speed is increased. Driving at moderate speeds will help to save fuel.

Reduce idling time

In vehicles with the Start-Stop system idling is automatically reduced. In vehicles without the Start-Stop system it is worth switching off the engine, for example, at level crossings and at traffic lights that remain red for long periods of time. When an engine has reached operating temperature, and depending on the cylinder capacity, keeping it switched off for a minimum of about 5 seconds already saves more than the amount of fuel necessary for restarting.

The engine takes a long time to warm up when it is idling. Mechanical wear and pollutant emissions are also especially high during this initial warm-up phase. It is therefore best to drive off immediately after starting the engine. Avoid running the engine at high speed.

Regular maintenance

Regular servicing helps in saving fuel even before the engine is started. A well-serviced engine gives you the benefit of **improved fuel efficiency** as well as maximum reliability and

an enhanced resale value. A badly serviced engine can consume up to 10% more fuel than necessary.

Avoid short journeys

The engine and catalytic converter need to reach their optimal **operating temperature** in order to minimise fuel consumption and emissions.

A cold engine consumes a disproportionate amount of fuel. The engine reaches its working temperature after about four kilometres (2.5 miles), when fuel consumption will return to a normal level.

Check tyre pressure

Always make sure the tyres are inflated to the correct pressures »» page 347 to save fuel. If the pressure is below half bar, fuel consumption may increase by 5%. Due to the greater rolling resistance, under-inflation also increases tyre wear and impairs handling.

Do not use winter tyres all year round as they increase fuel consumption by up to 10%.

Avoid carrying unnecessary loads

Given that every kilo of extra **weight** will increase the fuel consumption, it is advisable make sure that no unnecessary loads are being transported.

Since the luggage rack increases the **aerodynamic drag** of the vehicle, you should remove it when not needed. At speeds of 100-120 km/h (62-75 mph), this will save 12% of fuel.

Save electrical energy

The engine drives the alternator, thereby generating electricity. This implies that any increase in power consumption also increases fuel consumption! For this reason, switch off any unneeded electrical devices. Devices that use a lot of electricity include the blower at a high setting, the rear window heating or the seat heating.

Plug-in hybrid drive: brake early and evenly to take advantage of energy recovery.

Note

- If you have the Start-Stop system, it is recommended that it should not be disconnected.
- It is recommended that you close the windows when driving at more than 60 km/h (37 mph).
- Do not drive with your foot resting on the clutch pedal, as the pressure can make the plate slip. This causes wear and can damage the clutch plate.
- Do not ride the clutch on a hill, use the brake. The fuel consumption will be lower and you will prevent the clutch plate from being damaged.

- Use the engine brake on downhill by changing to the gear that is best suited for the gradient. Fuel consumption will be “zero” and the brakes will not suffer.

Driving with a loaded vehicle

In order to achieve appropriate driving characteristics when the vehicle is loaded, please note the following:

- Place all luggage securely >>> page 282.
- Accelerate with particular care and precaution.
- Avoid sudden braking and manoeuvres.
- Brake earlier than usual.
- If applicable, please note the information about the roof rack >>> page 292.

WARNING

Loads that move around could seriously threaten the vehicle's stability and safety, extend the braking distance during hard or emergency braking and lead to serious accidents and injuries.

- Secure the load correctly to prevent it from moving around.
- Secure heavy objects with suitable lashing straps or tie-down belts.
- Ensure that the rear seat backrests are securely engaged.

Driving with the rear lid open

Driving with the rear lid open is particularly dangerous. Secure all objects and the open rear lid correctly and take any necessary measures.

Driving with the rear lid open increases the aerodynamic drag of the vehicle, along with fuel consumption. It is therefore recommended that you do not drive with the rear lid open.

WARNING

Driving with the rear lid unlocked or open can cause serious injury.

- Always drive with the rear lid closed.
- Place all objects securely inside the luggage compartment. Otherwise, loose objects could fall out of the luggage compartment and injure road users driving behind.
- Always drive carefully and with special care and anticipation.
- Avoid braking and sudden manoeuvres, as the open rear lid could move uncontrollably.
- When transporting objects that protrude from the luggage compartment, mark them accordingly to warn other road users. Please bear in mind all legal provisions.
- Never use the rear lid to support or secure objects protruding from the luggage compartment.

- If a luggage rack is fitted on the rear lid, remove it and the load when you have to drive with the rear lid open.

NOTICE

An open rear lid changes the height and, in some cases, the length of the vehicle.

Note

Depending on the country, it may be forbidden to drive with the rear lid open. Please observe the legal regulations of the country in question.

Driving on flooded roads

To prevent damage to the vehicle driving on flooded roads, take the following into account:

- Water should **never** come above the lower edge of the bodywork.
- Drive at pedestrian speed.
- Never stop the vehicle in the water, drive in reverse or stop the engine.
- Vehicles driving in the opposite direction form waves that can raise the water level so high that your vehicle will not be able to cross the water safely.

WARNING

After driving through flooded zones, braking effectiveness can decrease if the brake discs or pads are damp >>> page 172.

Note

- Driving through flooded areas may severely damage vehicle components such as the engine, drive train or electrical system.
- Avoid driving through salt water (corrosion) >>> page 365.
- Whenever driving through water, the Start-Stop system must be switched off >>> page 159.

Running in

Please observe the instructions for running-in new components.

Running-in the engine

A new engine must be driven through a run-in period during its first 1500 kilometres (1000 miles). During its first few hours of running, the internal friction in the engine is greater than later on when all the moving parts have bedded down.

How the vehicle is driven for the first 1500 km (1000 miles) influences the future engine performance. Throughout the life of the vehicle, it should be driven at a moderate speed (es-

pecially when the engine is cold) this will reduce engine wear and increase its useful life. Never drive at extremely low engine speeds. Always engage a lower gear when the engine works "irregularly". **For the first 1000 km or 600 miles, please note:**

- Do not use full throttle.
- Do not force the engine above two thirds of its maximum speed.
- Do not tow a trailer.

Between 1000 and 1500 kilometres (600 to 1000 miles), gradually increase power until reaching the maximum speed and high engine speeds.

Running in new tyres and brake pads

- Replacement of wheel rims and new tyres >>> page 346.
- Information about brakes >>> page 172.



For the sake of the environment

If the engine is run in gently, the life of the engine will be increased and the engine oil consumption reduced.

Four-wheel drive (4Drive)

On four-wheel drive models, the engine power is distributed to all four wheels

General notes

On four-wheel drive vehicles, the engine power is distributed to all four wheels. The distribution of power is controlled automatically according to your driving style and the road conditions. See also >>> page 173.

The four-wheel drive is specially designed to complement the superior engine power. This combination gives the vehicle exceptional handling and performance capabilities, both on normal roads and in more difficult conditions, such as snow and ice. Even so (or perhaps especially for this reason), it is important to observe certain safety points >>> ⚠.

Winter tyres

Thanks to four-wheel drive, your vehicle will have plenty of traction in winter conditions, even with the standard tyres. Nevertheless, we still recommend that winter tyres or all-season tyres be fitted on all four wheels to give even better braking response.

Snow chains

On roads where snow chains are mandatory, this also applies to cars with four-wheel drive >>> page 350.

Changing tyres

On vehicles with four-wheel drive, all four tyres must have the same rolling circumference. Also avoid using tyres with varying tread depths >>> page 346.

Off-roader?

Your SEAT vehicle is not an off-roader: in fact, the ground clearance is not enough to be used as such. Avoid consequently rough tracks and uneven terrain.

WARNING

- **Even with four-wheel drive, you should always adjust your speed to suit the conditions. Do not let the extra safety features tempt you into taking any risks when driving. Accident hazard!**
- **The braking capability of your vehicle is limited by the tyres' grip. It is therefore no different from a car without four-wheel drive. So do not be tempted to drive too fast on firm or slippery roads just because the vehicle still has good acceleration in these conditions. Accident hazard!**
- **On wet roads bear in mind that the front wheels may start to "aquaplane" and lose contact with the road if the car is driven too fast. If this should happen, there will be no sudden increase in engine speed to warn the driver, as occurs with a front-wheel drive car.**

For this reason you should always choose a driving speed suitable for the road conditions. Accident hazard!

Trips abroad

The vehicle has been manufactured for a specific country and meets the approval regulations in force in that country at the time it was manufactured.

If you are going to use the vehicle abroad temporarily or for a short period of time, please observe the relevant instructions.

Some countries have special safety regulations and provisions that the vehicle may not comply with. Before travelling abroad, SEAT recommends that you seek information from one of your dealers about the legal provisions in force in your destination country.

If you are going to sell the vehicle in another country or use it there for a longer period of time, please observe the legal regulations in force in the country in question.

In some cases it may be necessary to install or remove certain equipment at a later date, and to deactivate certain functions. Sets and types of services may also be affected. In particular, this can occur if the vehicle is to be used in another climatic region for a long period of time.

Due to the different frequency bands around the world, the factory-fitted infotainment system may not work in another country.

With petrol vehicles, it should be ensured that lead-free petrol is available throughout the journey. Seek information about service station networks selling unleaded fuel.

SEAT importers and distributors will provide information about the technical preparation that your vehicle requires and also about necessary maintenance and repair possibilities.

NOTICE

SEAT does not accept liability for any damage to the vehicle due to the use of a lower quality fuel, an inadequate service or the non-availability of genuine spare parts.

Starting and stopping the engine

Switching the ignition on/off



Fig. 118 In the lower part of the centre console: start button.

The engine can be started with a start button (Press & Drive). For this there must be a valid key inside the passenger compartment.

Opening the driver's door **when exiting the vehicle** activates the electronic lock on the steering column if the ignition is disabled.

Switching the ignition on/off

If you only want to switch on the ignition (without starting the engine), briefly press the start button once **without pressing** the brake pedal or the clutch pedal >>> page 153.

The starter button text **START ENGINE STOP** flashes like a heartbeat when the system is preset for switching the ignition on and off.

Automatic ignition disconnection

When the vehicle detects that there is no driver once the engine has stopped, after a certain time the ignition is switched off automatically. If at that time the dipped beam headlights are on, the side lights will stay on for approx. 30 minutes. The side lights can be turned off by blocking the vehicle >>> page 94, or manually >>> page 118.

Automatic deactivation of the ignition on vehicles with the Start-Stop system

The ignition is switched off automatically when the vehicle is stopped and the automatic engine shutdown is active, if:

- The driver's seat belt is not fastened,
- the driver does not step on any pedal,
- the driver door is opened.

After automatically turning off the ignition, if the dipped beam D is on, the side light remains on for approx. 30 minutes (if the battery has enough charge). If the driver locks the vehicle or manually turns off the light, the side light goes out.

Switching off the ignition when leaving the vehicle, with hybrid drive

When the ignition is not switched off in E-MODE operating mode, a certain amount of time after the journey is complete it switches off automatically to prevent draining the 12-volt vehicle battery.

Function “My Beat”

For vehicles with a convenience key there is the “My Beat” function. This feature provides an additional indication of the vehicle ignition system.

When entering the vehicle, the start button **>>> Fig. 118** flashes to draw attention to it.

When the ignition is on/off, the engine start button flashes.

With the ignition is switched off, the start button goes off after a few seconds.

With the engine running, the start button light stays on, indicating that the engine is running. The time elapsed between the moment the user starts the engine with the start button and the lighting changes from flashing to fixed will depend on specific engine size characteristics. When the start button is used to stop the engine, the button starts flashing again.

In vehicles **with the Start-Stop system**, the “My Beat” function also offers additional information:

- When the engine stops during the Stop phase, the light of the start button stays on, as the Start-Stop system remains active even though the engine is off.
- When the engine cannot be started again with the Start-Stop system **>>> page 159** and needs to be started manually, the start button flashes to indicate this situation.

WARNING

When switching on the ignition, do not press the brake or clutch pedal, otherwise the engine could start immediately.



WARNING

If vehicle keys are used negligently or without due care, this may cause accidents and serious injury.


- **Never leave any key inside the vehicle when you leave it. Otherwise, a child or unauthorised person could lock the vehicle, start the engine or connect the ignition and operate any of the electrical equipment.**

Note


- **Before leaving the vehicle, always disconnect the ignition and, if appropriate, take into account the instructions on the screen of the dash panel.**


- **If the vehicle is stationary for a long time with the engine off and the ignition on, the vehicle battery might be discharged and it might not be possible to start the engine.**
- **In vehicles with diesel engines, wait until the warning light  goes off before starting the engine.**
- **If during the STOP phase you press the START ENGINE STOP button, the ignition is switched off and the push-button flashes.**
- **If the following indication appears on the instrument cluster display: “Start-Stop system deactivated: Start the engine manually”; the button  START ENGINE STOP will flash.**

Starting the engine

- *Vehicles with manual transmission:* put the gear lever in neutral, press the clutch pedal and keep it pressed in this position until the engine starts.
- *Vehicles with automatic transmission:* press the brake pedal and keep it pressed in this position until the engine starts.
- Press the start button without pressing the accelerator. There must be a valid key in the vehicle for the engine to start. After starting the engine, the lighting of the  START ENGINE STOP button remains fixed indicating that the engine is running.

- Once the engine starts, release the start button.
- If the engine does not start, stop and wait for around 1 minute to try again. If necessary, perform an emergency start >>> page 156.

Diesel engines can take a few seconds longer than usual to start on cold days. During pre-heating, the warning lamp  remains lit. To avoid unnecessary discharging of the battery, do not use any other major electrical equipment while the glow plugs are pre-heating.

The preheating time depends on the coolant and exterior temperatures. With the engine at operating temperature, or at outside temperatures above +8°C, the warning lamp  will light up for about one second. This means that you can start the engine almost immediately.

Starting a diesel engine after having run out of fuel

If the fuel tank of a diesel vehicle was run until completely empty, after refuelling it can last longer than normal to start the engine, even up to a minute. This is because the fuel system must eliminate air first.

WARNING

Do not keep the engine running in confined spaces, as there is a risk of poisoning.

- The exhaust gases contain carbon monoxide, an odourless and colourless poisonous gas that can cause loss of consciousness and death.

WARNING

Do not get out of the vehicle with the engine running, especially if a gear is engaged. The vehicle could then suddenly move or something strange could happen that would cause damage, fire or serious injury.

WARNING

Never use cold start sprays, they could explode or cause the engine to run at high revs. Doing this risks injury.

NOTICE

- The starter motor or the engine may be damaged if you try to restart the engine immediately after switching it off.
- When the engine is cold, you should avoid high engine speeds, driving at full throttle and over-loading the engine, as this could cause engine damage.

For the sake of the environment


Do not warm-up the engine by running the engine with the vehicle stationary. Start off immediately, driving gently. This helps the engine reach operating temperature faster and reduces emissions.

Note

Electrical components with a high power consumption are switched off temporarily when the engine starts.

- When starting with a cold engine, noise levels may briefly increase. This is quite normal, and no cause for concern.
- When the outside temperature is below +5 °C (+41 °F), if the engine is diesel, some smoke may appear under the vehicle when the fuel-operated auxiliary heater is on.

Turning off the engine

- Bring the vehicle to a full stop >>> .
- *Vehicles with manual transmission:* fully depress the clutch.
- *Vehicles with automatic transmission:* Switch on the parking lock by pressing button **P**.
- Apply the electronic parking brake.
- Briefly press the start button.

Car wash function (hybrid vehicles)

When the ignition is turned off with gear **N** activated, the vehicle can roll for the next 30 minutes. After that time, if the vehicle is stopped the parking lock **P** activates automatically. The corresponding warning message is displayed on the instrument cluster display one minute before this happens.

WARNING

Never switch off the engine while the vehicle is moving. This could cause loss of control of the vehicle, accidents and serious injury.

- The airbags and belt tensioners do not work when the ignition is switched off.
- The brake servo does not work with the engine off. Therefore, you need to press the brake pedal harder to brake the vehicle.
- Power steering does not work when the engine is not running. You need more strength to steer when the engine is switched off.
- If the ignition is switched off, the steering column could be locked, making it impossible to control the vehicle.

WARNING

Always take the key with you when you leave the vehicle. This is particularly important if there are children in the vehicle, as they might otherwise be able to start the engine or use power-operated equipment (e.g. the electric windows), which could cause injuries.

NOTICE

- If the vehicle is stopped and the Start-Stop system switches off the engine, the ignition remains switched on. Make sure that the ignition is switched off before leaving the vehicle, otherwise the battery could discharge.
- If the engine has been driven at high speed for a prolonged period of time, it may overheat when switched off. To avoid damage, allow the engine to run for approximately two minutes in neutral before switching it off.

Note

After the engine is switched off the radiator fan may run on for up to 10 minutes, even if the ignition is switched off. It is also possible that the fan turns itself on once more if the coolant temperature increases due to the heat accumulated in the engine compartment or due to its prolonged exposure to solar radiation.

Electronic immobilizer

The electronic immobiliser helps to prevent the engine from being started with an unauthorised key and, consequently, the vehicle being put in motion.

The vehicle key has an integrated chip which automatically deactivates the electronic immobiliser if there is a valid key inside the passenger compartment.

The electronic immobiliser is automatically activated when there is no longer a valid key inside the vehicle.

For this reason, the engine can only be started with a properly coded Original SEAT key. This type of keys can be purchased from a SEAT dealer.

NOTICE

A perfect operation of the vehicle is ensured if genuine SEAT keys are used.

Emergency starting function



Fig. 119 On the centre console: emergency start.

If no valid key is detected inside the vehicle, an emergency start-up will be required. The relevant message will appear in the dash panel display. This may happen when, for example, the vehicle key battery is very low.

- Immediately after pushing the start button, place the key in the drink holder of the centre console »» Fig. 119, as close as possible to the Kessy logo.
- The ignition connects and the engine starts automatically.

Indications for the driver on the instrument cluster screen

Depress the clutch

- This indication is displayed on vehicles with a manual gearbox when the driver does not depress the clutch pedal when starting the engine. The engine can only be started if the clutch pedal is depressed.

Press the brake

- This message appears on vehicles with an automatic gearbox if the driver tries to start the engine without having the brake pedal pressed.

Press the brake to engage a gear

- This indication is displayed when starting or stopping the engine if the automatic transmission selector lever is in position **D** or **R** and the brake pedal is not depressed. The engine can only be started and stopped in these positions.

Engage position **P**; the vehicle can move; doors can only be locked in position **P**.

- For safety reasons, this driver message appears and an audible warning sounds if the parking lock button **P** is not pressed after switching off the engine. Press button **P** otherwise the vehicle could move.

Ignition is switched on

- This driver message is displayed and a buzzer is sounded when the driver door is opened with the ignition switched on.

Driving with electric drive

Switching on the hybrid drive system

✓ Valid for: hybrid vehicles

Switching on the hybrid drive activates the vehicle's propulsion system. When the vehicle's drive system is switched on, the electric drive is activated. The combustion engine starts automatically when the charge level of the high-voltage battery is not sufficient to run with the electric drive, or if high drive power is required.

To access driving with the electric drive in the infotainment system:

- > **Battery manager**.

Requirements for switching on the drive system

The drive system can be switched on when the following conditions are met:

- The high voltage battery has a sufficient charge level.
- There is no charging cable plugged in.
- The temperature of the high-voltage battery is within the operating range.
- There is a valid remote control key in the vehicle.

Switching on the drive system

- Press the ignition and start button once. The ignition must be switched on.
- Press the brake pedal and keep it pressed.
- Set the gear selector switch to position **N** or activate the parking lock **P**.
- Press the ignition and start button until indicator lamp **READY** lights up on the instrument cluster. Do not press the accelerator. Release the ignition and start button when the indicator lamp **READY** lights up on the instrument cluster. The mark on the power display changes from **OFF** to **0**.
- If the indicator lamp **READY** does not light up, cancel and repeat the operation.
- If the vehicle has been locked with the remote control key, the ignition and start button is deactivated. If you are inside the vehicle and have to start the engine, first unlock the vehicle or perform an emergency start »» page 156.

Note

A click is heard when the drive system is turned on. This is completely normal and does not mean there is a problem.

Detecting the drive system

With the electric drive, the motor makes no noticeable noise when the drive system is switched on or while driving. Therefore, you cannot detect that the vehicle's drive system

is on by engine noise. Instead, the following characteristics show that the vehicle is ready to drive:

- The indication **0** »» page 23 is displayed on the power gauge of the instrument cluster.
- The display light on the instrument cluster is on, regardless of whether the vehicle's exterior lighting is on.
- The indicator lamp **READY** is on in the instrument cluster display.
- An audio signal is heard.

Switching on the drive system in very low outside temperatures

If the outside temperature is very low (approximately -27°C [-16°F] or lower), the high-voltage battery may freeze and stop working. In this case it's not possible to switch on the drive system.

As soon as the temperature of the high-voltage has increase enough, the drive system can be switched on again.

To ensure that the drive system can be switched on, even in very low outside temperatures, SEAT recommends parking the vehicle in a place protected from the cold.

Behaviour when moving off or stopping

The combustion engine only runs if necessary. When the vehicle is stationary, the combustion engine is normally switched off and the vehi-

cle's electrical systems are powered by the high-voltage battery. The rev counter on the instrument cluster remains at **0** »» page 23.

The combustion engine switches off in certain driving conditions. This is normal and aims to save fuel. In general, the power steering and brake assist systems remain on. In isolated cases the system may require the combustion engine to carry on running even when the vehicle is stationary.

In traffic jams the combustion engine may start up while the vehicle is stationary to recharge the high voltage battery for subsequent *driving off* and *stopping* phases.

Vehicle sound

✓ Valid for: hybrid vehicles

The electric drive makes much less noise than a combustion engine. In the versions for some countries, artificial vehicle sound is generated to allow the vehicle to be heard better from the outside. At higher speeds, when the noise produced by the tyres and the wind increases, the vehicle's sound automatically fades out.

WARNING

During electric driving, the auditory perception of the vehicle by other road users may be much lower. This is especially true in traffic-restricted areas and when manoeuvring or reversing. Accident hazard!

Troubleshooting

✓ Valid for: hybrid vehicles



Drive: Fault! Stop the vehicle safely

The warning lamp lights up red.

There is a fault in the vehicle's drive system. The vehicle's drive system is no longer available. Park the vehicle in a safe place as soon as possible. Seek professional assistance.



Drive: Fault! The electric drive is not working properly. Visit a workshop

The warning lamp lights up yellow.

There is a fault in the vehicle's drive system. Drive slowly to a specialised workshop to have the fault repaired.



Drive: Warning! Power is limited. Check the manual

The warning lamp lights up yellow.

Performance limited. The high-voltage battery may not be sufficiently charged or may have reached its operating temperature limit, for example in very cold outside temperatures.



Vehicle sound: Fault! Pedestrians cannot hear the vehicle. Visit a workshop

The warning lamp lights up yellow.

There is a vehicle sound fault. Drive with utmost care, as other road users may not be able to hear the electric vehicle. Go immediately to a specialised workshop to have the fault repaired.

Operating mode selection

Operating mode selection

✓ Valid for: hybrid vehicles

The vehicle has different operating modes so that it can always be optimally adjusted to every situation while driving. Once the drive system has been turned on, and provided that all of the operating conditions required for this purpose have been met, the **E-MODE** operating mode is always activated in the first instance for electric driving.

Operating mode selection

- Switch on the drive system.
- Access the **Battery manager** menu of the infotainment system (☰ > **Battery manager** >>> page 81).
- Press the **E-Mode** or **Hybrid** function button in the infotainment system. Further information about the operating mode can be found in ①.

E-MODE (driving in electric mode)¹⁾

In the E-MODE electric driving mode, the vehicle basically drives in electric only mode. To the extent possible, the vehicle's combustion engine is not used.

All of the following conditions must be met for E-MODE to be activated:

- The high voltage battery has a sufficient charge level.
- The vehicle speed is lower than 130 km/h (80 mph).
- The high voltage battery temperature is above -10°C.

If, while driving in E-MODE mode, the necessary conditions are no longer met, the combustion engine starts and electric driving is suspended. In this case, the indicator (⊘) lights up on the instrument cluster display.

The combustion engine starts when a kick-down occurs in E-MODE. However, E-MODE remains activated.

Hybrid (use the battery's charge)¹⁾

This is the operating mode that allows you to save most fuel.

The operating mode control unit tries to make the most of the battery charge. For this purpose, with active directions the navigation data are also accessed.

¹⁾ The displayed symbol varies depending on the active operating mode and the charge level of the high-voltage battery.

In this operating mode, the electric motor and the combustion engine share the work of driving the vehicle.

In hybrid operating mode, the power from the battery charge is used optimally. If route guidance is activated, the vehicle may autonomously recharge the high-voltage battery using the combustion engine.

Manual control of the battery charge

Manual control of the battery charge is only possible in **Hybrid** operating mode. The option selected by the user is only valid until the ignition is switched off or the vehicle is switched to Hybrid mode or E-MODE.


Press the function button  and use the symbols ,  and  to control the battery charge:

- ▶ Pressing this symbol selects a higher theoretical charge level. The vehicle tries to reach that new theoretical high-voltage battery charge level while driving. The vehicle is powered by the combustion engine. If the combustion engine has "excess" power, it is used to charge the high-voltage battery. This option increases fuel consumption. SEAT therefore recommends using the charging socket to charge the high-voltage battery, whenever possible >>> page 76.

- = The high-voltage battery charge level is kept at around the current level while driving. If you accelerate harder or increase the vehicle speed, the combustion engine starts up. When permitted by the driver's demand for acceleration and the vehicle speed, the vehicle switches back to electric mode.
- ◀ Pressing this symbol selects a lower theoretical charge level. The vehicle only uses the battery's charge when it is above the selected theoretical charge level. The rest is kept until the end of the journey.

The **Intelligent Hybrid** App allows the user to save electrical energy until reaching home [charging point] with just "one click". If this option is not selected, the maximum amount of electrical energy will be consumed until the selected destination is reached. If the user has no active route, the function will offer the activation of a predictive route and BMA mode from the widget itself with just one click.

Show the active operating mode

The operating mode active at any given time is displayed on the instrument cluster display, e.g. .

WARNING


Switching to a different operating mode while driving can distract you from traffic conditions and cause accidents.

Note


Information about the operating mode that is currently active is displayed on the instrument cluster display, along with the charge level of the high-voltage battery.

Troubleshooting

✓ Valid for: hybrid vehicles

 E-MODE operating mode is not available

The indicator lamp lights up in white.

The E-MODE operating mode  (driving in electric mode) cannot be used temporarily because one or more conditions are not met.

- The conditions must be met to use the E-MODE operating mode.

Start-Stop system

Description and operation

Not valid for PHEV hybrid vehicles


The Start-Stop system helps you to save fuel and reduce CO₂ emissions.


In Start-Stop mode, the engine will automatically switch off when the vehicle stops or is stopping. The ignition remains switched on. The engine automatically switches back on when required.

In this scenario, the light of the START ENGINE STOP button remains lit.¹⁾

When the ignition is switched on, the Start-Stop function is automatically activated.


Control lamps

 The Start-Stop system is available, the automatic engine shutdown is active.

 The Start-Stop system is not available or has been disconnected.

Stopping and starting the engine


Vehicles with a manual gearbox:

- When the vehicle is stopped, put it into neutral and release the clutch pedal. The engine will stop. The warning lamp  will light up on

the display. The engine may be stopped before the vehicle comes to a standstill (approximately 7 km/h).

- When you depress the clutch pedal, the engine will start again. The indicator lamp goes out.

Vehicles with an automatic gearbox:

- Brake until the vehicle has come to a standstill, and keep your foot on the brake pedal or activate the Auto Hold system so that the vehicle remains braked. The engine will stop. The warning lamp  will appear on the display. The engine may stop before the car stops completely (approximately 7 or 2 km/h depending on the vehicle's gearbox²⁾).

- When you take your foot off the brake pedal the engine will start up again. The indicator lamp goes out. With the Auto Hold system, the engine will not start if you remove your foot from the brake pedal. The car starts when you press the accelerator pedal.


Basic requirements for the start/stop mode

- The driver door must be closed.
- The driver's seat belt must be fastened.
- The bonnet must be closed.
- The engine has reached operating temperature.

- The reverse gear must not be engaged.
- The vehicle must not be on a very steep slope.

The engine does not turn off for various reasons


Before stopping the vehicle, the system verifies whether certain conditions are met. The engine **does not** switch off, in the following situations for example:

- The engine has not yet reached the required temperature for the Start-Stop mode.
- The temperature selected on the climate control has not been reached.
- The interior temperature is very high/low.
- De-icing function button  activated.
- Park assist is switched on.
- The battery is very low.
- The steering wheel is overly turned or is being turned.
- If there is a danger of misting.
- After engaging reverse gear.
- In case of a very steep gradient.
- In a traffic jam after stopping for the fifth time, the engine will not stop any more.
- With ESC disabled.
- After emergency braking or loss of adhesion.

¹⁾ Only in vehicles with Keyless Access.


²⁾ In the mHEV version (semi-hybrid), above 20 km/h.

- With a trailer attached.
- While the particle filter is regenerating.

 is displayed on the instrument cluster screen; it is also displayed in the driver information system, START STOP.

The engine starts by itself

When stopped, the normal system mode may be interrupted in the following situations. The engine restarts without the driver's intervention.

- The interior temperature differs from the temperature selected on the climate control.
- Defrost function button activated .
- The brake is pressed several times in a row.
- The battery is not charged enough.
- High electricity consumption.
- The vehicle rolls forward or backward with the engine off.
- ESC deactivated.
- The accelerator pedal (automatic transmission), or the clutch (manual transmission) is pressed.
- The steering wheel is turned slightly¹⁾.
- When the air conditioning is activated.

Additional information related to the automatic gearbox

The engine stops when the selector lever is in **D**, **N** and **S**, as well as in Tiptronic mode. When the parking lock button **P** is activated, the engine will also remain off when you remove your foot from the brake.

In order to start the engine up again the accelerator must be pressed, or another gear engaged or the brake released.

If the selector lever is placed in **R** while stopped, the engine will start up again.

Additional information about vehicles with Adaptive Cruise Control (ACC)

In vehicles with ACC function, the engine will start up again in certain operating conditions if the radar sensor detects that the vehicle ahead drives off again.

WARNING

- **Never switch the engine off until the vehicle is stationary. The operation of the brake and steering will not be fully guaranteed. More force will be needed to turn the steering wheel or to brake. You could suffer an accident and even serious injuries.**
- **To avoid injury, make sure that the Start-Stop system is switched off when working in the engine compartment >>> page 162.**

NOTICE

The Start-Stop system must always be switched off when driving through flooded areas >>> page 150.

Note

- **In vehicles with an automatic gearbox, you can control whether the engine should switch off or not by reducing or increasing the brake force applied. While the vehicle remains stopped, the engine will not stop if the brake pedal is slightly pressed, in traffic jams with frequent stopping and starting for example. As soon as strong pressure is applied to the brake pedal, the engine will stop.**
- **When stopped, the brake pedal must be kept pressed to ensure that the vehicle does not move.**
- **If the engine "stalls" with a manual gearbox, it can be directly started up again by immediately pressing the clutch pedal.**
- **If the lever is placed in position D, N or S after engaging reverse gear, 10 km/h (6 mph) in a forwards direction must be reached for the system to be in a condition to stop the engine.**

¹⁾ Except for the MHEV version.

Manually connecting and disconnecting the Start-Stop system

Not valid for PHEV hybrid vehicles

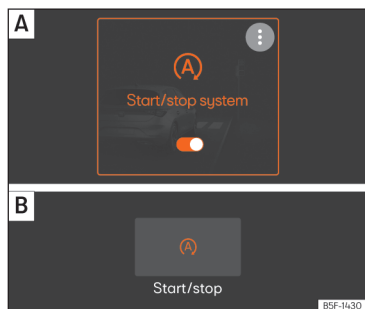


Fig. 120 On the infotainment system display: Start-Stop system on. **A** View in the main menu. **B** View with the Infotainment system off.

If you do not wish to use the system, you can switch it off manually:

- In the infotainment system select > **Assistants** > **Smart Assistants**.

When the symbol appears in orange >>> **Fig. 120** the system is on and will stop and start. When the symbol appears in white the system is off.

Note

The system switches on every time the engine is turned off voluntarily.

Troubleshooting

Not valid for PHEV hybrid vehicles

Indications for the driver on the instrument cluster screen

Start-Stop system deactivated. Start the engine manually

- This indication shows that the Start-Stop system **cannot** restart the engine.

This happens for 2 reasons: if the driver's door has been opened or if the driver has unbuckled the seat belt.

Start-Stop system: Fault! Function not available

- There is a fault in the Start-Stop system. Take the vehicle to a workshop to have the fault repaired.

Manual gearbox

Changing gears

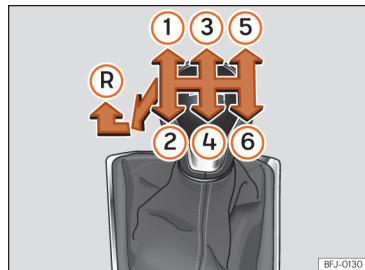


Fig. 121 Diagram of a 6-speed manual gearbox.

Gear positions are indicated on the gear lever >>> **Fig. 121**.

- Depress the clutch and keep your foot as far as it will go.
- Move the gear lever to the desired position.
- Release the clutch.

Engaging reverse gear

Only engage reverse gear when the vehicle is stopped.

- Depress the clutch and keep your foot as far as it will go.
- With the gear lever in neutral, push it down, move it all the way to the left and then forwards to select reverse gear »» Fig. 121 (B).
- Release the clutch.

Changing to lower gears

When driving, you should always change down through the gears progressively, i.e. to the gear immediately below when engine RPM is not too high »» ⚠. Skipping one or several gears when changing down through the gears at high speed or high RPM can cause damage to the clutch and gearbox, even if the clutch is depressed »» Ⓜ.

⚠ WARNING

If the engine is running, the vehicle starts moving as soon as a gear is engaged and the clutch pedal is released. This also happens if the electronic parking brake is switched on.

- Never engage reverse gear while the vehicle is in motion.

⚠ WARNING

Changing down through the gears incorrectly by selecting a gear that is too low can lead to loss of control of the vehicle and cause accidents and serious injuries.

Ⓜ NOTICE

Engaging a gear that is too low when driving at high speed or at high engine RPM can cause considerable damage to the clutch and gearbox. This can happen even if the clutch pedal is kept depressed and the gear is not engaged.

Ⓜ NOTICE

Consider the following to avoid damage and premature wear:

- Do not rest your hand on the gear lever while driving. The pressure exerted by the hand is transmitted to the gearbox forks.
- Do not rest your foot on the clutch pedal; even if the pressure seems insignificant, it can cause premature wear of the clutch disc. Use the footrest when not changing gears.
- Make sure the vehicle is completely stopped before engaging reverse gear.
- When changing gears, always fully depress the clutch.
- Do not "ride" the clutch with the engine running when the vehicle is stopped on an uphill slope.

DSG automatic transmission

Introduction

Your vehicle is equipped with an electronically controlled manual gearbox. Torque between the engine and the gearbox is transmitted via two independent clutches. They replace the torque converter found on conventional automatic gearboxes and allow for smooth, uninterrupted acceleration of the vehicle.

The **Tiptronic** system allows the driver to change gears *manually* »» page 165, *Changing gear in Tiptronic mode*.


Gear selector positions



Fig. 122 On the centre console: selector lever.


The gear selector position is shown by the corresponding sign lighting up. The engaged gear is also displayed on the screen in manual shift positions **M**, **D**, **S** and **E** (when the **Eco** >>> **page 170** engine setting is selected in the **Individual** profile).

P - Parking lock

When the **P** button is pressed, the drive wheels are locked. Only press **P** when the vehicle is stationary >>> .

To press the **P** button you must press the brake pedal simultaneously.


R - Reverse gear

Reverse gear must be engaged only when the vehicle is stationary and the engine is idling >>> .

To engage reverse gear **R**, you must press the brake pedal simultaneously. The reverse lights switch on when the reverse gear **R** is selected and the ignition is on.

N - Neutral

In this position, the gear is in neutral.

Press the brake pedal to move the lever from **N** to **D/S** when the vehicle is stationary or at speeds below 3 km/h (2 mph) >>> .

D/S - Permanent forward drive position

The **D/S** position enables the gears to be operated in normal mode (**D**) or sport mode (**S**). To select Sport mode **S**, move the lever backwards. Pushing the lever again will select normal mode **D**. The selected driving mode is displayed on the instrument panel screen.

In **normal mode (D)**, the gearbox selects the best gear ratio. This depends on the engine load, speed and the dynamic regulation program (DRP).

Sport mode (S) should be selected for a sporty driving style. This setting makes use of the engine's maximum power output. When accelerating, gear shifting operations are perceptible.

Under certain circumstances (e.g. on mountain roads) it can be advantageous to switch tiptronic mode >>> **page 165**, to adapt the gears to suit the road conditions.

WARNING

- Take care not to press the accelerator pedal when the vehicle is stopped. The vehicle could start moving immediately (in some cases even if the parking brake is engaged) resulting in the risk of an accident.
- Never move the lever to position **R** when driving. Failure to follow this instruction could result in an accident or failure.

- With lever in any position, the foot brake must be depressed whenever the engine is running. This is because an automatic gearbox still transmits power even at idling speed.

- Do not accelerate while selecting a gear, with the car stationary and the engine running. Failure to follow this instruction could result in an accident.

- The driver must never leave the vehicle while the engine is running and with a gear engaged. Switch on the electronic parking brake and select the parking lock (**P**).

Note

- If the lever is moved accidentally to **N** when driving, release the accelerator and let the engine speed drop to idling before selecting gear range **D** or **S** again.
- If the power supply is interrupted while the **P** parking lock is active, it will not be possible to move the lever. If this should happen the manual release can be used. In this case, you should seek professional assistance.

Note

- If a gear has been selected, the vehicle does not move forwards or back. Proceed to the next mode:
 - If the vehicle does not move in the desired direction, the gear ratio may not be correctly engaged by the system. Depress the brake pedal and reselect the gear range.
 - If the vehicle still does not move in the desired direction, there is a system failure. Seek specialist help and have the system checked.

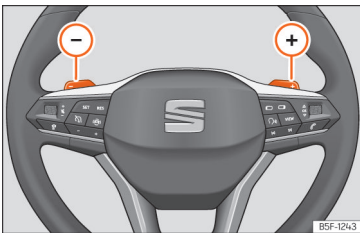
Changing gear in Tiptronic mode

Fig. 123 Steering wheel: automatic gearbox levers

Tiptronic gives the driver the option to change gears manually.

When you change to the Tiptronic programme, the vehicle remains in the currently selected gear. This is possible as long as the system is not changing gear automatically due to a traffic situation.

Using Tiptronic with the steering wheel paddles

The gear shift paddles can be used when the selector lever is in the **D/S** position.

- Press the (+) gear shift paddle to change up a gear >>> **Fig. 123**.
 - Press the (-) gear shift paddle to change down a gear.
 - To exit the Tiptronic mode, pull the right-hand gear shift paddle towards the steering wheel for approximately 1 second.
- To keep Tiptronic mode permanently switched on, move the selector lever to the **S** position. If the selector lever is in position **D** and the gear shift paddles are not operated for some time, the Tiptronic mode will automatically be switched off.

NOTICE

- When accelerating, if a higher gear is not selected, it will automatically change shortly before reaching the maximum permitted RPM.
- Also, if a lower gear is selected, the system will not change until it detects that the engine will not reach its maximum RPM.

Driving with an automatic gearbox

Shifting to a higher or lower gear is automatic.

The engine can only be started with the lever in the **N** position and the **P** button must be lit up (the parking lock remains active).

Driving downhill

Under certain circumstances it may be advantageous to use the Tiptronic mode to select the gear manually according to driving conditions >>> **△**.

Stop/Park

To park on flat ground, just press the **P** >>> **Fig. 122** button. On slopes the parking brake should first be applied and then press the **P** button.

If the driver door is opened and the **P** button has not been activated, the vehicle could move. The following warning is displayed on the instrument panel: **⚠ Gear change: Selector lever in the drive position!** A buzzing sound is also heard.

Stopping on a downhill

Always apply the brake pedal firmly to prevent the vehicle from moving; if necessary, apply the electronic parking brake >>> **△**.

Do not accelerate while a range of gears is engaged to prevent the car from rolling downhill >>> **⊙**.


Starting off uphill with the Auto Hold function

- Once you have engaged a gear, take your foot off the brake pedal and gently press the accelerator.

Starting off uphill without the Auto Hold function


- Pull on the electronic parking brake button.
- Once you have engaged a gear, gently press the accelerator and pull on the electronic parking brake button.

WARNING

Observe the safety warnings >>>  in *Gear selector positions* on page 164.


- Never allow the brake to rub and do not use the brake pedal too often or for long periods, as the brakes can overheat. This reduces the braking power, increases the braking distance or even causes a brake system fault.
- If you have to stop on a hill, keep the vehicle's brakes applied with the brake pedal or parking brake.

NOTICE

- When stopping the vehicle on an uphill slope, do not try to avoid shifting into gear and depressing the accelerator. This could overheat and damage the automatic gearbox.
- If you allow the vehicle to roll with the lever in position **N** and the engine off, the automatic gearbox will be damaged due to a lack of lubrication.
- In certain driving situations or traffic conditions, the gears could overheat and be damaged! If the warning lamp  lights up, stop the vehicle as soon as you can and wait for the gearbox to cool >>> page 168.
- If the gearbox operates in emergency mode, have the fault repaired by a specialist workshop without delay.

Kick-down

The kick-down device provides maximum acceleration when the gear selector lever is in the positions **D**, **S** or in Tiptronic mode.

When the accelerator pedal is fully depressed, the automatic transmission shifts to a lower gear, depending on speed and engine speed. This uses the vehicle's maximum acceleration >>> .

The shift to the next higher gear will not take place until the preset maximum engine RPM is reached.

WARNING



Please note that if the road surface is slippery or wet, the kickdown feature could cause the driving wheels to spin, which could result in skidding.

Launch-control program

The Launch-control programme enables maximum acceleration from a standstill.

Condition: the engine must have reached operating temperature and the steering wheel must not be turned.


The engine speed for Launch-control is different for petrol and diesel engines.

To use the Launch-control you must disconnect the traction control (TCS) or activate the ESC Sport mode, using the Infotainment system menu: press the function button  > **Assistants** > **ESC menu**. The warning lamp  will remain on.

- Press the brake pedal with your left foot and hold it down for at least one second.
- Set the selector lever to position **S** or Tiptronic, or select the **Sport** driving profile from the Drive Profile.

- With your right foot, press the accelerator down to the full throttle or kick-down position. The engine speed will stabilise at about **3,200 rpm** (petrol engine) or about **2,000 rpm** (diesel engine).
- Take your left foot off the brake pedal. The vehicle starts with maximum acceleration.

WARNING

- Always adapt your driving style to the traffic conditions.
- Only use the Launch control programme when road and traffic conditions permit, and make sure your manner of driving and accelerating the vehicle does not inconvenience or endanger other road users.
- Make sure that the ESC remains switched on. Please note that when the TCS and ESC are deactivated, the wheels may start to spin, causing the vehicle to lose grip. Accident hazard!
- After moving off, you should activate the TCS or deactivate the ESC "sport" mode again using the Infotainment system: function button  > Assistants.

Note

- Dynamic driving or using a launch-control program may considerably raise the temperature of the catalytic converter or gearbox. In this case, the program may be out of service for a few minutes. The program may be used again once the cooling phase is complete.
- Accelerating with the Launch control programme places a heavy load on all parts of the vehicle. This can result in increased wear and tear.


Inertia mode

The inertia mode allows you to travel certain distances without using the accelerator, which saves fuel. Plan ahead and use the inertia mode to let the vehicle roll.

Activation of the inertia mode

Condition: lever in position **D**, slopes of less than 12% and speeds between 20 and 130 km/h (12 and 80 mph).

- Gently take your foot off the accelerator.

The indication will be shown on the instrument panel , the engaged gear and current consumption will disappear and the word **Inertia** will appear.

The gears will automatically disengage and the vehicle will roll freely, without the effect of the engine brake. While the vehicle rolls, the engine runs at idling speed.

Stopping inertia mode

- Press the brake or the accelerator pedal.

To take advantage of the engine's inertia mode, simply remove your foot from the accelerator.

Applying both the **inertia mode** (= prolonged section with less energy) and **inertia disconnection** (= shorter section without the need for fuel) facilitates improved fuel consumption and emission balance.

If the vehicle has **SEAT Drive Profile**

»» **page 170**, the inertia mode can be activated in **Normal**, **Eco** and **Individual** modes. In **Eco** mode, it is activated whenever the operating conditions are met, regardless of the smoothness with which the foot is removed from the accelerator.

WARNING

- If the inertia mode has been switched on, take into account, when approaching an obstacle, that the vehicle will not decelerate in the usual manner: risk of accident!
- When using inertia mode while travelling down hills, the vehicle can increase speed: risk of accident!
- If other users drive your vehicle, warn them about inertia mode.

NOTICE

The operation of the inertia mode in combination with hybrid engines (MHEV and PHEV) can cause the combustion engine to switch off.

NOTICE

The inertia mode will be automatically disconnected on gradients steeper than 15%.

Troubleshooting**The engine will not start.**

The indicator lamp lights up green.

The brake is not depressed, e.g. when trying to change the gear selector lever.

- To select a gear range, press the brake pedal.

Indications on the instrument cluster display:

Clutch**Clutch overheated! Please stop!**

- The clutch has overheated and could be damaged. Stop and wait for the gearbox to cool with the engine idling and press the **P** parking lock button. When the warning lamp and the driver message turn off, go to a speci-

alised workshop to get the fault repaired. If they do not turn off, do not continue driving. Seek specialist assistance.

Faults in the gearbox**Gearbox: Fault! Stop the vehicle and place the lever in the P**

- There is an anomaly in the gearbox. Stop the vehicle in a safe place and do not continue driving. Seek specialist assistance.

Gearbox: System fault! You may continue driving

- Have the fault corrected by a specialised workshop without delay.

Gearbox: System fault! You can continue driving with restrictions. Reverse gear disabled

- Take the vehicle to a specialised workshop and have the fault repaired.

Gearbox: System fault! You can continue driving in D until switching off the engine

- Stop the vehicle in a safe place. Seek specialist assistance.

Gearbox: too hot. Adapt your driving accordingly

- Continue driving slowly. When the warning lamp goes out, you can continue driving normally.

Gearbox: press the brake and engage a gear again

- If the warning was caused by the temperature of the gearbox, this driver message will be displayed when the gearbox has cooled again.

Emergency mode

If all the gear positions are shown over a light background on the instrument cluster, there is a system fault and the automatic gearbox will operate with the backup programme. It is still possible to drive the vehicle, however, at low speeds and within a selected range of gears. **Driving in reverse gear may not be possible.**

Parking lock manual release mechanism

If, in the event of a power failure (e.g. the 12-volt vehicle battery is drained), the vehicle must be towed and the parking lock can be released manually. In this case, you should seek professional assistance.

Driving on slopes**downhill assistant**

Downhill speed control is activated when the gear lever is in the **D/S** position and the brake is applied. An appropriate lower gear is engaged.

The assistant attempts to maintain the speed at which the vehicle was travelling when the brake was applied, within logical limits. It may be necessary to correct the speed by pressing the brake.

The assistant can only change down as far as 3rd gear. It is possible that on very steep slopes you may have to switch to tiptronic mode and thus manually change down to 2nd or 1st gear to take advantage of engine braking and take the load off the brake system.

Downhill speed control is deactivated as soon as the road levels out again or you press the accelerator pedal.

On vehicles with a cruise control system
 >>> **page 181**, downhill speed control is activated when you set a cruising speed.

WARNING

The downhill speed control cannot defy the laws of physics. Therefore, speed cannot be maintained constant in all situations. Always be prepared to use the brakes!

Steering

Information relating to different vehicle processes.

To make the vehicle more difficult to steal, always lock the steering before leaving the it.

Steering

On vehicles with electromechanical steering, the power steering automatically adjusts according to the driving speed, the steering wheel torque and the orientation of the wheels. The power steering only works when the engine is running.

If the power steering does not work properly or does not work at all, you will have to use much more strength than usual to turn the steering wheel.


Progressive steering

Depending on the vehicle's features, it may or may not incorporate a progressive steering system.

In *city traffic* you do not need to turn so much on parking, manoeuvring or in very tight turns.

On *roads or motorway*, progressive steering transmits, for example, in bends, a sportier, more direct and noticeably more dynamic driving sensation.

Steering assist

This help assists the driver in critical situations. It recommends turning the steering wheel to perform a corrective manoeuvre (counter-steering), turning slightly to avoid skidding >>> .

WARNING


Steering assist helps the driver in critical situations. The driver is the person who has to control the vehicle's steering at all times.

Troubleshooting

Steering fault

The warning lamp lights up red.

There is a fault in the power steering.

-  **Stop driving!** Seek specialist assistance.
- Do not allow the vehicle to be towed on its own wheels.

Steering fault

The control lamp lights up or flashes yellow.

The steering is stiffer or reacts more sensitively than usual.

The control lamp **lights up and remains lit**:

- Restart the engine and drive slowly for a short distance. Contact a specialist workshop if the control lamp remains on.
- **OR:** the 12-volt battery was disconnected and reconnected. Drive slowly for a short distance.

The control lamp **flashes**:

- Turn the steering wheel slightly from one side to the other.
- Turn off the ignition and turn it on again.

- Consider the warnings shown on the instrument cluster display.
- If the control lamp continues flashing after the ignition has been switched on, do not continue driving. Seek specialist assistance.

SEAT Drive Profiles

Introduction

The driver can use the drive profiles to adapt various features of the vehicle's systems to the current driving situation, the desired driving comfort and an economical driving style. Some of the systems that can be adapted are the suspension, steering, engine and air conditioning.

Depending on the vehicle's equipment, various drive profiles can be selected. The degree of influence of the vehicle's systems on the different drive profiles depends on the vehicle's equipment.

Engine

Depending on the profile selected, the engine responds more quickly or smoothly to the accelerator being pressed. When the **Eco** profile is selected, the Start-stop function is activated.

In vehicles with automatic transmission, the gear change timing is changed to put the changes at higher or lower revolutions. The **Eco** profile activates the Inertia function, thereby re-

ducing consumption. The rest of the driving profiles will activate the inertia use function when the gear selector lever is not in the **S** position, depending on how the accelerator pedal is released >>> **page 167**. When the vehicle is turned on again, the function is activated by default to reduce consumption.

With manual transmission, the **ECO** profile changes the gear change recommendations to facilitate more efficient driving.

Adaptive chassis control (DCC)

The DCC continuously adapts the damping of the suspension system to the characteristics of the road surface and the driving situation (speed, acceleration and steering wheel angle) according to the selected driving profile. The vehicle's dynamic behaviour is also adapted to improve grip on curves and turning capacity. Within the **Individual** profile you can also adjust the DCC level in a customised manner. In the event of a fault in the DCC, the following message is displayed on the instrument cluster display > **Fault: damping adjustment**.

Four-wheel drive (4Drive)

Modify the transmission to adjust the vehicle's traction capacity to the road surface. The acceleration capacity from a standstill will also be modified.

Steering

The operation of the power steering is modified and adapted to the selected profile to offer the best behaviour for each situation.

Air conditioning

Climatronic can operate in **Eco** mode, especially restricting fuel consumption.

Adaptive Cruise Control (ACC)

Depending on the driving profile, the performance of the ACC to allow adaptation to a speed that is more sporty or fuel consumption-friendly.

PreCrash system





The PreCrash system adapts according to the selected configuration >>> **page 50**.

The **Sport** driving profile has specific settings to adapt to driving characteristics.

Selecting a driving profile

The drive profile can be selected when the ignition is switched on and the vehicle is stationary or moving >>> **△**.


Selecting a driving profile

- Press the  > **Drive Profile** function button.
- **OR:** Press the function button  > **Vehicle settings** > **SEAT Drive Profile**, available profiles will be displayed.
- **OR:** Press the function button , swipe your finger horizontally across the screen to **SEAT Drive Profile**. Press  to change the driving profile or double press on the icon to show the available profiles.
- **OR:** With the Infotainment System turned off, by pressing on the **SEAT Drive Profile** icon, the available driving profiles will be displayed.

Displaying the drive profile information

- To display more information on the selected drive profile, press **Information** in the infotainment system.

Kick-down

The kick-down feature allows maximum acceleration  page 165.

If the **Eco** profile has been selected in the SEAT Drive Profile, and the accelerator is pressed beyond a hard point, the engine power is automatically controlled to give your vehicle maximum acceleration.





WARNING


Adjusting the driving profile while driving can distract attention from traffic and cause accidents.

- Always drive as carefully and responsibly as possible.

Characteristics of driving profiles

The icon of the selected profile is displayed at all times in the upper central part of the instrument panel and on the Infotainment System screen when it is turned off.

Driving profile	Characteristics
 Eco	Places the vehicle in a low state of consumption, facilitating a fuel-saving driving style that is respectful to the environment.
 Comfort^{a)}	It permits more relaxed and comfortable driving, for example for long motorway journeys.
 Normal	Offers a balanced driving experience, suitable for everyday use.
 Sport	Provides a complete dynamic performance in the vehicle, enabling the user a more sporty driving style.

Driving profile	Characteristics
 Individual	It allows you to personalise the configuration. The functions that can be adjusted depend on the equipment fitted in the vehicle.

^{a)} Only for models fitted with adaptive chassis control (DCC).

WARNING

Your speed and driving style must always be adjusted to visibility, weather, and traffic conditions.

Note

- Regardless of the driving profile selected when the ignition is switched off, all systems will start up Normal mode. To select a different driving profile, use the infotainment system display.
- Your speed and driving style must always be adjusted to visibility, weather, and traffic conditions.
- Use of the Eco profile is not recommended when driving with a trailer.

Braking system

Information about the brakes

During the first 200 to 300 km, **new brake pads** do not provide maximum braking power and still have to "settle" >>> ⚠. **When running in the brake pads, the emergency braking distance is longer** than after they have been run in. During the run-in, avoid sharp braking and situations that place a lot of demand on the brakes, e.g. driving too close to another vehicle.

Brake pad wear depends to a large extent on the conditions in which the vehicle is used, and driving style. If the vehicle is frequently used in city traffic and for short distances, or for sporty driving, brake pad thickness should be checked regularly at a specialist workshop.

Driving with **wet brakes**, e.g. after driving through water, in heavy rain or after washing the vehicle, braking performance may be affected by wet brake discs, or even frozen discs in winter. The driver should be ready to brake harder.

If **the brake discs and pads have a layer of salt on them**, the braking performance is reduced and the braking distance increases. When driving on salted roads without braking for some time, the layer of salt should be removed by carefully applying the brakes a few times >>> ⚠.

Corrosion on the brake discs and **dirt** on the brake pads increase if the vehicle is left unused for a long time, if it is not driven for many kilometres. If corrosion is present, it is recommended to clean the discs and pads by braking hard several times while driving at high speed. Make sure that you do not endanger any other vehicles or road users >>> ⚠.

⚠ WARNING

Driving with worn brake pads or a defective brake system can lead to accidents and serious injuries.

- If you suspect that the brake pads are worn or that the brake system is faulty, have the brake pads checked immediately by a specialist workshop and replaced if they are worn.

⚠ WARNING

The braking performance of new brake pads is not optimal.

- During the first 300 km, new brake pads do not provide maximum braking power and still have to "settle". This can be counteracted by applying more pressure to the brake pedal.
- When brake pads are new, drive with extra care to reduce the risk of accidents, serious injury or loss of control of the vehicle.

- Only perform hard braking to clean the brake system when permitted by the traffic situation. Do not endanger the occupants of other vehicles. Accident hazard!

- When running in new brake pads, do not drive too close to other vehicles or cause situations that would require the brakes to be applied heavily.

⚠ WARNING

When the brakes overheat, their braking performance drops and the braking distance increases.

- When driving downhill, particular demand is placed on the brakes and they heat up very quickly.
- Before a long steep slope, reduce speed and change down into a lower gear or range. Therefore, using the engine brake relieves the brakes.
- If you wish to retrofit a front spoiler, integral trim or other accessories, ensure that the air inlet around the brakes is not reduced, as otherwise the brake system could overheat. Please also note the information on brake fluid >>> page 332.

⚠ WARNING

Wet, frozen or salt-covered brakes take longer to brake and increases the braking distance.

- Test the brakes carefully.
- Always dry the brakes and free them from ice and salt by braking repeatedly, if permitted by visibility, weather, road surface and traffic conditions.

⚠ WARNING

When braking manoeuvres are started automatically, the brake pedal may move automatically in the application direction. Do not put your foot under the brake pedal. Risk of injury!

i Note

Never let the brakes “drag” by leaving your foot on the pedal when it is not necessary to brake. This can cause the brakes to overheat, resulting in increased brake travel and wear. Please consider the important notes on brake fluid »» page 332.

i Note

Regularly check the thickness of the brake pads visually through the holes in the rims or from the underside of the vehicle. If necessary, the wheels should be removed for a more thorough inspection. SEAT recommends visiting a SEAT dealership for this.

Troubleshooting**⚠ Defect in the brake system**

The warning lamp lights up red. A message may also be displayed.

🛑 Stop driving!

- Inform a specialist workshop and request a brake system inspection.

🟡 Brake pad wear indicator

The control lamp switches on yellow.

The front brake pads are worn.

- Contact a specialised workshop immediately.
- Get **all** the brake pads inspected and replace if necessary.

Brake assist systems**Information relating to brake assist systems**

Brake assist systems can help the driver in critical driving or braking situations. The driver is responsible for driving safely »» ⚠.

When the brake assist systems are regulating the brakes, the brake pedal may move or make noises. Even so, continue to brake with the necessary force and control the trajectory of the vehicle if necessary.

Depending on the equipment, the ESC and TCS settings may be changed in the vehicle.

- The ESC, ABS and TCS can only operate correctly if the four wheels are fitted with the stipulated tyres »» ⚠.
- If a fault occurs in the ABS, the ESC, TCS and EDS also cease to function.

Electronic Stability Control (ESC)

The ESC helps to reduce the risk of skidding and to improve stability in certain driving situations »» ⚠.


Traction control (TCS)

The TCS reduces the driving force on skidding wheels and adapts this force to suit the road surface conditions. The TCS facilitates starting, acceleration and hill climbing »» ⚠.

Electronic brake pressure distribution (EBV)

Electronic brake force distribution (EBV) regulates the braking force between the front and rear axles. Excessive braking of the rear axle is avoided and the vehicle remains stable during the braking operation.

Anti-lock braking system (ABS),

The ABS can prevent the wheels from locking up under braking until shortly before the vehicle comes to a stop, and helps the driver maintain control of the steering and the vehicle »» .

Brake assist (BAS)

Brake assist (BAS) can help to reduce the braking distance. Brake Assist increases the pressure exerted by the driver when the brake pedal is depressed quickly in an emergency.

Electronic differential lock (EDS and XDS)

The EDS automatically brakes skidding wheels and transmits the driving force to the other driving wheels.

XDS improves traction by applying the brakes to improve cornering acceleration.

Multi-collision brake

The multi-collision brake automatically triggers braking if the airbag control unit detects a collision in the event of an accident.


Automatic braking requirements:

- The driver is not pressing the accelerator pedal.

Trailer stabilisation

Note that the vehicle-trailer assembly generally tends to snake. When the snaking of the trailer is felt by the vehicle and detected by the ESC, it will automatically brake the towing vehicle within the limits of the system and stabilise the vehicle-trailer set. Tractor-trailer sway mitigation is not available in all countries »» page 300.

Electromechanical brake servo (eBKV)

With the ignition switched on, the electromechanical brake servo (eBKV) supplements the force exerted by the foot by increasing the pressure that the driver exerts on the brake pedal »» . When a driver assistance system applies the brakes, e.g. ACC when regulating the speed, or during emergency braking, the brake pedal may move automatically.

After disconnecting the ignition, the assistance of the brake servo is progressively reduced. If you continue to hold the vehicle in place with the brake pedal, messages are displayed on the instrument cluster screen. In this case, the brake servo function is restricted.

Once stopped, immobilise the vehicle to prevent it from moving »» page 208.

Brake blending¹⁾

The regulated application of the brakes blends the braking effect of the electric motor in energy recuperation and the mechanical braking by the driver.

WARNING

Smart brake assist technology cannot overcome the limits imposed by the laws of physics and only works within the limits of the systems. Driving at high speed on icy, slippery or wet road surfaces can cause a loss of control of the vehicle and serious injury to the driver and passengers.

- Adapt your speed and driving style at all times to suit visibility, weather, road and traffic conditions. Never take any risk that compromises safety.
- Brake assist systems cannot prevent an accident if you are driving too close to other vehicles.
- Always use suitable tyres. Driving stability depends on tyre grip.

¹⁾ Valid for hybrid vehicles

WARNING

The efficiency of the ESC can be significantly reduced if components or systems that affect the driving dynamics are not properly maintained or are not working properly. This can particularly occur if changes are made to the suspension or unauthorised rim/tyre combinations are used.

- Ensure that vehicle conversions and modifications are only made by specialised workshops.
- Always use suitable tyres. Driving stability depends on tyre grip.

WARNING

When driving without a brake servo or with restricted brake servo functions, the braking distance can increase considerably and can cause accidents and serious injuries.

- If the brake servo is not working, the brake pedal has to be pressed harder, as the braking distance increases due to the lack of assistance from the servo brake.


Connecting and disconnecting the ESC and TCS


The ESC is switched on automatically when the engine is started, and only works when the engine is running and includes the ABS, EDS and TCS systems.

The TCS function should only be switched off in situations in which traction is insufficient.


Depending on the finishes and versions, there is the possibility of disconnecting only the TCS or activating the ESC in "Sport" mode.

Disconnecting and connecting the TCS


- The TCS can be turned on or off in the infotainment system: function button  > **Assistants** > **ESC menu** >>> page 38.

When the TCS is off, the control lamp  lights up on the instrument cluster.

Disconnecting and connecting the ESC in "Sport" mode

- The ECS in "Sport" mode can be turned on or off in the infotainment system: press the function button  > **Assistants** > **ESC menu** >>> page 38.

When "Sport" mode is connected, the interventions of the ESC to stabilise the vehicle, and the traction control (TCS) interventions are limited.

In vehicles with 4-wheel drive, the TCS is disconnected completely. In addition, the  control lamp lights up on the instrument cluster.

WARNING

The ESC Sport mode should only be switched on if the traffic situation and the driver's ability allow it. Danger of skidding!

- With ESC in Sport mode, the stabilising function will be limited for sportier driving. The vehicle may skid.

Note

If the TCS is disconnected or "Sport" mode is selected, the cruise control system will be switched off.

Troubleshooting

The ABS does not work properly or does not work at all

The control lamp switches on yellow.

- Contact a specialised workshop. The vehicle's brakes still work without the ABS.


The ESC or TCS is regulating

The control lamp flashes yellow.

ESC fault

The control lamp switches on yellow. The ESC has been switched off.




There is a fault or defect.

- Turn off the ignition and turn it on again.
- If possible, drive for a short distance at 15-20 km/h (9-12 mph).
- If the control lamp  is still on, go to a specialised workshop.

The brake assist systems make noises

When the described brake assist systems intervene, you may hear noises.

WARNING

- When the ignition is switched on, the status of the brake system and the brake assist functions are automatically checked. The control lamps on the instrument cluster light up briefly and then go out. Any indicator lamp that remains on indicates a fault. Seek qualified technical assistance immediately.
- If the brake system warning light  comes on together with the  control lamp, the ABS regulation function may not work and the rear wheels may lock relatively quickly when braking. This can lead to loss of control of the vehicle! If possible, slow down and drive slowly and carefully to the nearest specialist workshop to have the brake system inspected. During this journey, avoid heavy braking and any sudden manoeuvres.
- If the control lamp  does not go out, or comes on while driving, it means that the ABS is not working properly. The vehicle can only be stopped using normal braking (without

ABS). In this case the protective ABS function will not be available. Go to a specialised workshop as soon as possible.

Assistant systems

General notes

Safety advice

⚠ WARNING

- Responsibility for driving rests with the driver at all times. The drive assist systems are not a replacement for driver attention. Focus all your attention on driving and be prepared to intervene at all times.
- Use the drive assist systems only when conditions allow. The driving style must always be suitable for the weather, visibility, road and traffic conditions.
- In order for drive assist systems to react correctly, sensors and cameras must operate without limitations. Please read the notes on sensors and cameras in this chapter.

i Note

- Keep in mind the specific rules of each country, especially when it comes to driving, formation of an emergency corridor, braking distance, speed, parking position, wheel position, etc. The driver is solely responsible for always complying with the specific regulations of each country.

- The area in front of and around the radar sensor should not be covered with adhesives, additional headlights or similar items, as this could have a negative impact on the operation of the assistants. If the vehicle is not properly repaired or structural modifications are made to it, the operation of the assistants may be affected.
- The repair and adjustment of sensors and cameras requires special knowledge and tools. It is recommended to visit a SEAT dealership for this purpose.

System limits

⚠ WARNING

- Drive assist systems can not overcome the laws of physics. Depending on the circumstances, a collision may not be avoidable.
- Warnings, notices and indicator lamps may not be displayed on time, or may be displayed incorrectly, e.g. if a vehicle approaches too quickly.
- Corrective interventions by drive assist systems (e.g. interventions in the steering or brakes) may be insufficient or may never occur, depending on the circumstances. As a driver, you must be prepared to act at all times.

i Note

- Due to the system's detection limits in the surroundings, the systems may not give warnings or intervene on time, or they might do so even if it is not desired. In addition, the auxiliary systems may incorrectly interpret a manoeuvre and, as a result, warn the driver in an unexpected manner.
- When the towing mode is selected, some assist systems may react with limitations, in an unusual way or may not be available. Keep in mind the instructions relating to the towing mode.

Button for the assistant systems




Fig. 124 On the turn light and main beam lever: key for driver assistance systems [depending on the version].



Fig. 125 Left side of the multifunction steering wheel: button for driver assistance systems (depending on the version).

Depending on the equipment, the button for the driver assistance systems is located on the turn signal and main beam lever or on the multifunction steering wheel. This button can be used to switch the driver assistance systems in the **Assistants** menu on and off.

- Press the  button to open the **Assistants** menu.
- Select the assistance system in question and turn it off or on. A mark indicates that assistant system is switched on.
- Next, confirm the selection by pressing the **OK** button on the multifunction steering wheel.

The assistant systems can also be switched on and off in the infotainment system, in the vehicle settings menu **>>> page 38**.

Drive assist sensors and cameras

Front radar



Fig. 126 On the front bumper: radar sensor.

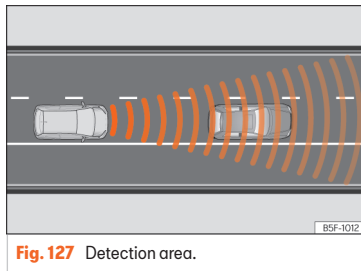


Fig. 127 Detection area.

A radar sensor may be fitted to the front bumper of the vehicle **>>> Fig. 126**. The front radar detects any objects in its detection zone **>>> Fig. 127** and provides support for the following functions:

- Front Assist **>>> page 193**.
- Adaptive Cruise Control (ACC) **>>> page 185**.

The radar can have a range of up to 120 m (400 ft) depending on road and weather conditions.

WARNING

- The visibility of the radar sensor can be impaired by dirt or environmental influences such as rain, fog, snow, mud, dust, insects etc. In this case the Front Assist and ACC functions may stop working. The instrument panel displays the following message: **No sensor vision!** And the Front Assist unavailable or ACC unavailable warning lights come on.
- Clean the sensor area on the bumper as indicated in **>>> page 366, Cleaning the exterior**. When the radar sensor starts correctly detecting again, the message disappears from the screen and the functions become available again.

NOTICE

- If the radar sensor is dirty or poorly adjusted, the Front Assist system may give unnecessary warnings and apply the brakes inappropriately.
- The operation of the radar can be affected by strong reflections of the emitted signal. This may occur, for example, in an enclosed car park or due to the presence of metallic objects (e.g. guard rails or sheets used in road works).
- The sensor may not be adjusted correctly if it receives an impact. This may compromise the system's efficacy or disconnect it. If you have the feeling that the radar sensor is damaged or adjusted incorrectly, switch off the Front Assist and ACC functions to avoid any damage. If this occurs have it adjusted.

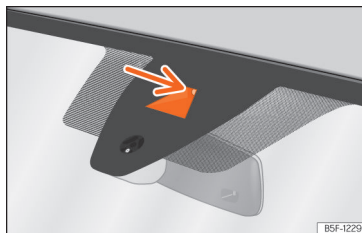
Front camera

Fig. 128 On the windscreen: field of vision of the Lane Assist system camera.

Depending on the equipment, the vehicle may be fitted with a front camera on the front windscreen. This camera detects lane boundaries (lines) to provide support for the following functions:

- Lane Assist >>> page 197.
- Travel Assist >>> page 199.
- Emergency assist >>> page 203.

NOTICE

To avoid affecting the operation of the systems, take the following points into consideration:

- Clean the field of vision of the camera regularly and make sure it is free of snow and ice.
- Do not cover the field of vision of the camera.
- Check that the windscreen is not damaged in the area of the camera's field of vision.

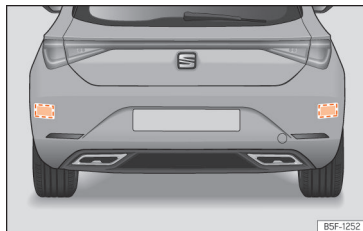
Rear radar

Fig. 129 Rear view of the vehicle: radar sensor areas.

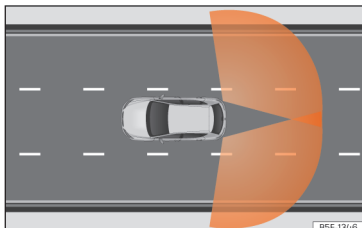


Fig. 130 Sensor detection zones.

The radar sensors are located on the left and right of the bumper and are not visible from the outside »» Fig. 129. The sensors monitor both the blind spot and traffic behind the vehicle »» Fig. 130.

They support the following functions:




- Side Assist »» page 205.
- Rear Cross Traffic Alert »» page 227.
- Exit Warning »» page 228.

Automatic deactivation of supported functions

The rear radar sensors deactivate automatically when, among other reasons, one of the sensors is detected to be permanently covered. This may be the case if, for example, there is a layer of snow or ice in front of one of the sensors.

The relevant text message will appear in the instrument panel display.

Indicator lamps

-  Side Assist function not available
-  Rear Cross Traffic Alert function not available.
-  Exit Warning not available.

! NOTICE

- The radar sensors on the rear bumper may be damaged or shifted in the event of a collision, for example, when entering or exiting a parking space. This may result in the system disconnecting itself, or at least possibly having its functionality diminished.
- In order to ensure that the radar sensors work properly, keep the rear bumper free of snow and ice and do not cover it.
- The rear bumper should only be painted with paint authorised by SEAT. The lane departure warning's functions may be limited or work incorrectly if other paints are used.
- The visibility of radar sensors may be affected due to leaves, snow, strong haze or dirt, among others. Clean the area in front of the sensors.
- Never use auto lane changing or the rear cross traffic alert if the radar sensors are dirty.

- Radar operation may also be affected if objects such as bicycle racks or luggage racks interfere with the visibility of the radars.

Ultrasound sensors

The bumpers are fitted with ultrasound sensors to perform the following functions:

- Park Assist »» page 217.
- Park assist plus »» page 213.
- Rear park assist »» page 216.

! NOTICE

- Damage to the radiator grille, bumper, wheel arch and vehicle underbody can modify the orientation of the sensors. This can affect the parking aid function. Have the function checked by a specialised workshop.
- A number plate or number plate holder with dimensions that exceed the space for the number plate, or a cured or deformed number plate can cause false detections or a loss of visibility for the sensors.

Note

- In order to guarantee good operation, keep the sensors clean, free of snow and ice, and do not cover them with stickers or other objects.
- If you use high-pressure or vapour equipment for cleaning, do not apply it directly, unless you do so very briefly, and always keep a distance of more than 10 cm away.
- Fitting certain accessories to the front of the vehicle, such as a plate holder with advertising, may interfere with the operation of the Park Assist.

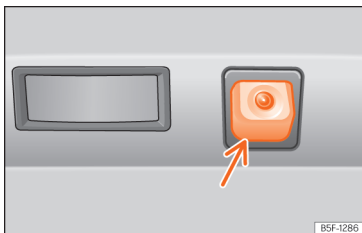
Rear camera

Fig. 131 On the rear bumper: location of the rear assist camera.

A camera on the rear bumper aids the driver when reverse parking or manoeuvring. This provides support to the following function:

- Rear View Camera »» page 224.

WARNING

Fitting a number plate frame may interfere with the view shown on the screen, as it may reduce the camera's field of vision.

NOTICE

- In order to guarantee good system operation, keep the cameras clean, free of snow or ice, and do not cover them with stickers or other objects.
- Never use abrasive cleaning products to clean the camera lens.
- Do not use hot or warm water to remove ice or snow from the camera lens. Doing so could damage the camera.

Cruise control system**Introduction**

The cruise control system (GRA) helps maintain a constant speed set by you.

Speed range


The cruise control system is available when driving in forward gear at a speed of over approx. 20 km/h (15 mph).


Temporarily switching off the cruise control

The saved speed can be exceeded at any time, e.g. for overtaking. The cruise control is suspended during acceleration and is then resumed with the saved speed.

Status display

When the cruise control system is switched on, the instrument cluster display shows the saved speed and the system status:

 It lights up grey.
The cruise control system is switched on, but regulation is not active.

 It lights up green.
The cruise control system is switched on and regulation is active.

If there is no speed saved, the instrument cluster display shows --- instead of speed.

Changing gears

As soon as the clutch pedal is depressed, regulation is suspended and resumes once the gear change has been made.

Driving down slopes

Shift into a low gear before descending a long hill. This makes use of engine braking and relieves the brakes.

The vehicle cannot maintain the saved speed in all driving situations. Always be ready to apply the vehicle's brakes.

WARNING

If it is impossible to drive with sufficient braking distance and at a constant speed, using the cruise control system may cause accidents and serious injuries may occur.

- Do not use Travel Assist when visibility is bad, on steep roads, on windy roads or in slippery circumstances (such as snow, ice, rain or loose gravel), or on flooded roads.
- Only use the cruise control system on paved roads with a firm surface.
- Adapt your speed and safety distance to the vehicle in front of you at all times to suit the visibility, weather, road and traffic conditions.
- After use, always switch off the speed limiter to prevent the speed being regulated against your wishes.
- It is dangerous to use a set speed which is too high for the prevailing road, traffic or weather conditions.

Operating the cruise control



Fig. 132 On the multifunction steering wheel: cruise control operation buttons.

Connecting

- Press the  button.

There is no speed saved and regulation is not yet operating.

Start regulation

- While driving, press the button **SET**.

The cruise control system saves and regulates the current speed.

Adjusting the speed

While the GRA is set, the stored speed can be adjusted:

RES + 1 km/h (1 mph)


SET - 1 km/h (1 mph)

- + + 10 km/h (5 mph)
- - 10 km/h (5 mph)

The cruise control system only operates the acceleration, **it does not brake** the vehicle.

In hybrid vehicles the cruise control system changes the current speed by accelerating or braking.

Interrupting the adjustment

- Briefly press the button , or press the brake pedal.

The speed is stored.

Reinstating the cruise control

- Press the **RES** button.


The cruise control system resumes the saved speed and regulates it.

Switching off

- Press and hold the button .

The cruise control system switches off and the saved speed is deleted.

Switching off the speed limiter

- Press the  button.
- Select the speed limiter on the instrument cluster display.

The cruise control system is switched off.

Troubleshooting

Cruise control fault

The control lamp switches on yellow.

Abnormal operation. Switch off the cruise control system and take the vehicle to a specialist workshop.

The adjustment is interrupted unexpectedly

- If the clutch pedal is pressed for a long time.
- The vehicle has exceeded the saved speed for a long time.
- No forward gear has been selected.
- A brake assistance system has intervened, e.g. TCS or ESC.
- Front Assist has braked the vehicle.
- If the fault continues, disconnect the Emergency Assist and consult a specialised workshop.

Speed limiter

Introduction

The speed limited helps the driver not to exceed a set speed.

Speed range

The speed limiter helps avoid exceeding a programmed speed, from 30 km/h (20 mph) approx. and faster.

By selecting the speed limiter

The speed limitation can be interrupted at any time by depressing the accelerator pedal fully, beyond the point of resistance. As soon as the saved speed is exceeded, the green indicator light flashes and an audible warning signal may sound. The speed is stored.

The limiter is reactivated automatically after returning to less than the set speed.

Status display

When the speed limiter is switched on, the instrument cluster display shows the saved speed and the system status:



It lights up grey

The speed limiter is switched on but regulation is not active.



Lights up green

The speed limiter is switched on and active.

Driving down slopes

Shift into a low gear before descending a long hill. This makes use of engine braking and relieves the brakes.

The vehicle cannot maintain the saved speed in all driving situations. Always be ready to apply the vehicle's brakes.

WARNING

After use, always switch off the speed limiter to prevent the speed being regulated against your wishes.

- **The speed limiter does not relieve the driver of their responsibility to drive at the appropriate speed. Do not drive at high speed if not necessary.**
- **Using the speed limiter under adverse weather conditions is dangerous and can cause serious accidents, e.g. aquaplaning, snow, ice, leaves, etc. Only use the speed limiter when the status of the road and the weather conditions allow it.**

Operating the speed limiter



Fig. 133 On the multifunction steering wheel: buttons to control the speed limiter.

Connecting

- Press the button.

Regulation has not yet taken place.

Start regulation

- While driving, press the button **SET**.

The current speed is saved as a limit speed.

Adjusting the speed

The programmed speed can be set:

- RES** + 1 km/h [1 mph]
SET - 1 km/h [1 mph]
 + + 10 km/h [5 mph]
 - - 10 km/h [5 mph]

Interrupting the adjustment

- Press the button.

The speed is stored.

Reinstating the cruise control

- Press the **RES** button.

The limiter will re-activate as soon as the vehicle is moving at a speed lower than the saved one.

Switching off

- Press and hold the button .

The speed limiter switches off and the speed is deleted.

Switch to another driver assistance system

- Press the button.
- Observe the corresponding message on the instrument cluster display. The speed limiter is switched off.

Troubleshooting

LIM The speed limiter is not available

The control lamp switches on yellow.

- Malfunctions Switch off the speed limiter and go to a specialist workshop.

The adjustment is interrupted unexpectedly

- You have switched off the Electronic Stabilization Control (ESC).
- The brakes have overheated. Wait for the brakes to cool down and check the operation again.
- If the fault continues, consult a specialised workshop.


For safety reasons, the speed limiter only switches off fully whenever the driver stops pressing the accelerator pedal or switches the system off manually.

Eco-efficient driving assistance



Fig. 134 Eco-efficient driving assistance indication (schematic representation).

Eco-efficient driving assistance helps you drive with care and with low energy consumption by following instructions superimposed in the digital cockpit, depending on the situation.

When you approach places such as a junction, a roundabout or a section of road with a speed limit, the symbol  is displayed along with an event on the digital instrument cluster **>>> Fig. 134.**

As soon as you follow the indication and take your foot off the accelerator, the vehicle adapts, based on the selected driving profile and distance to the incident, brake energy recuperation and speed.

Eco-efficient driving assistance uses the trip data from the infotainment system and the sensors of some assist systems. If no destination guidance is active, the most likely route is used.

Pressing the accelerator can cancel the intervention of the assistance at any time.

Eco-efficient driving assistance can be switched on and off in the infotainment system, in the assistance system settings **>>> page 38.**

Eco-efficient driving assistance is temporarily switched off if:

- The gear selector is in the **S** position.
- The **Sport** driving program is used.
- Driving with adaptive cruise control (ACC) or cruise control (GRA).

When these conditions no longer exist, the assistance is reactivated if it is switched on in the assist system settings.

Eco-efficient driving assistance is available depending on the equipment, although not in all countries.

WARNING

The system is not a replacement for driver awareness.

- **Adapt your speed and driving style at all times to suit visibility, weather, road and traffic conditions.**
- **Traffic signs on the road and traffic regulations have priority over eco-driving notes.**

Note

- **The appearance of the symbols may vary slightly depending on the equipment and model. System updates may modify or expand the symbols.**
- **When the system is switched on, eco-efficient driving assistance can also increase energy recuperation without any indication being displayed. This can occur in situations such as when the accelerator pedal is released when a vehicle is driving in front. In this case, energy recuperation is adapted match the speed of the vehicle in front without any indication being displayed.**

ACC - Adaptive Cruise Control

Introduction

Adaptive Cruise Control (ACC) maintains a constant speed set by the driver. When approaching another vehicle in front, the ACC detects it and adapts the speed automatically, maintaining a distance set by the driver.

Does my vehicle have ACC?

Your vehicle has ACC if it has the ACC function buttons on the multifunction steering wheel **>>> page 110**, or if it has the configuration menu in the infotainment system.

Speed range

ACC regulates at speeds between 20 and 210 km/h (15 and 130 mph).

When **E-Mode** is activated in hybrid vehicles, the ACC speed range may vary.


If the vehicle is fitted with an automatic gearbox, the ACC can bring the vehicle to a standstill if a vehicle in front of it stops.

If your vehicle is fitted with a manual gearbox, you should pay attention to gear changes. The ACC could switch off if the RPM gets too high or low.

Driving with ACC

You can override the ACC at any time. Braking interrupts the ACC. If you accelerate, regulation is interrupted during acceleration and then resumed.

Driver intervention prompt

 ACC is subject to certain limitations inherent to the system. This means that the driver will have to control the speed and distance from other vehicles in certain situations. In this case, the instrument cluster display **will tell you to intervene** by applying the brake, and an audio warning will be played.

Radar sensors

The ACC uses the front radar technology. Read its maintenance instructions and information about its limitations » page 177.

WARNING

The ACC's technology cannot overcome the system's inherent limitations or change the laws of physics. If used negligently or involuntarily, it may cause serious accidents and injuries. The system is not a replacement for driver awareness.

- Always be prepared to brake or accelerate.
- If you press the accelerator pedal the ACC will stop working. Therefore, it will not brake or request any braking intervention.

- Adapt your speed and safe distance to the vehicle in front of you at all times to suit visibility, weather, road and traffic conditions.

- Do not use the ACC in poor visibility, or on roads that are steep, with lots of curves or slippery.

- Never use ACC when driving off-road or on unpaved roads.

- The system may not react in time to stationary obstacles (such as a traffic jam queue), particularly at high speeds. React soon enough to avoid a hazardous situation.

- The system may not react to stopped vehicles in the same lane. You must react early enough yourself in this case.

- The system does not react to people, animals or vehicles that are crossing or approaching in the opposite direction.

- If you are driving with a spare wheel fitted, the ACC system could automatically switch off. Switch off the system when starting off.

- Brake immediately if the ACC does not slow down enough.

- Brake immediately when a driver intervention instruction is displayed on the instrument cluster screen.

- If the vehicle continues to move involuntarily after a driver intervention prompt, brake the vehicle.

- The brake pedal may move downwards during braking. Be careful not to position your foot under the pedal.

Note

If the ACC does not work as described in this chapter, do not use it until it has been checked by a specialised workshop. Visiting a SEAT dealership is recommended.

ACC operation

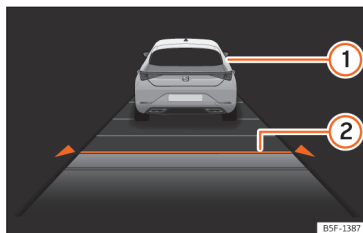


Fig. 135 On the instrument cluster screen: ACC active.



Fig. 136 On the multifunction steering wheel: buttons for operating the ACC.

»» Fig. 135

- ① Vehicle detected in front. It will light up if the distance to the vehicle is adjusted.
- ② Selected distance level 2.

This information can be displayed on the central panel of the **Assistants** view, or in the left hand information profile »» **page 18**. If these views are not selected, it will be automatically displayed in the lower central part of the instrument cluster in a simplified manner.

The set speed will be displayed next to the function status indicator.

Connecting

- Press the  button on the multifunction steering wheel »» **Fig. 136**.

The ACC does not regulate anything yet (standby).

Start regulation

Activating the ACC system also automatically activates the ESC and traction control (TCS).

- To start regulation, press the button **SET**
- »» **Fig. 136**.

The ACC saves the current speed and maintains the set distance. If the current speed is outside the preset speed range, ACC sets the minimum speed (if driving slowly) or maximum speed (if driving fast).

Depending on the driving situation, the following indicator lamps come on:



Valid for the analogue instrument cluster.

Lights up green

The ACC is active.



Lights up green

ACC connected, no vehicle detected in front.



Lights up green

ACC connected, vehicle detected in front.

When the ACC is in standby, the indicator lamps light up grey.

Program the speed



To program the speed, press the + or –

»» **Fig. 136** buttons to the desired speed. The speed is adjusted at intervals of 10 km/h (5 mph).

While the ACC is active, you can press the **RES** button to increase the desired speed by 1 km/h (1 mph). You can then press **SET** to decrease it by 1 km/h (1 mph).


Program the distance setting

The distance can be set to one of five levels, from very short to very long:

- Press the button  and then the button + or –
- »» **Fig. 136**.
- Alternatively, press the button  as many times as necessary to set the desired distance.

Keep in mind each country's regulations on minimum braking distances.

Suspend regulation (standby)

- Briefly press the button  »» **Fig. 136** or press the brake pedal.


The ACC indicator lamp is grey; the speed and distance are saved.

If the ESC or TCS is switched off, the ACC is automatically interrupted.


Reinstating the cruise control

- Press the **RES** button. The ACC regulates to the last speed and distance setting.
- **OR:** Press the button **SET** to regulate to the current speed.

Switching off

- Press and hold the button . The set speed is cleared.

Exceeding the speed regulated by the ACC

While driving with the ACC switched on, the driver can increase speed by pressing the accelerator pedal. ACC regulation is suspended until you release the accelerator pedal >>> .

Changing the driving profile

In vehicles with the SEAT Drive Profile, the selected driving profile can have an influence on the ACC's acceleration and braking behaviour >>> page 170.

In vehicles without SEAT Drive Profile, the behaviour of the ACC can also be affected if any of the following drive profiles are selected in the infotainment system in **Drive assist**. ACC settings will be the same as those in the SEAT Drive Profile.

WARNING

Before driving off, check that the road is clear. The radar sensor may not detect obstacles that could be on the road. This can lead to an accident and serious injury. Press the brake if necessary.

NOTICE

If you increase speed using the accelerator pedal, the ACC may not be able to safely adjust the speed of the distance due to the limitations of the system.

- **Be prepared to react if required by the situation.**

Special driving situations

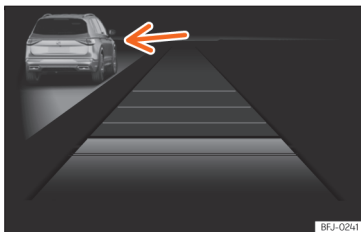


Fig. 137 On the instrument cluster screen: ACC active, vehicle detected on the left.

Be aware of the limitations and warnings described at the beginning of this chapter >>> page 185, *Introduction*.

Avoid undertaking on the right¹⁾

If a vehicle is detected in the left lane that is travelling at a speed slower than that set by the driver, it will brake the vehicle within the comfort limits of the system to avoid passing it on the right >>> **Fig. 137**.

You can cancel this regulation by changing the set speed or by pressing the accelerator pedal.

The function works at speeds over 80 km/h (50 mph). It may not be available in certain countries.

Overtaking

When the turn signal is switched on for overtaking, the ACC reduces the distance from the vehicle in front to help with the overtaking manoeuvre. The set cruising speed will not be exceeded.

The function works at speeds over 80 km/h (50 mph). It may not be available in certain countries.

Stop&Go function

The ACC can bring the vehicle to a standstill if the vehicle in front stops. *Vehicles with manual gearboxes:* you will need to keep the clutch pedal depressed to allow the car to come to a complete stop.

¹⁾ Or on the left, in countries that drive on the left hand side of the road.

The ACC remains active and the message **ACC ready to start** is displayed on the instrument cluster for a few seconds. You can extend or reactivate this warning by pressing the button **RES** or by grabbing the wheel if your vehicle is fitted with Travel Assist. During this time, the vehicle will move off again if the vehicle in front moves forwards.

To move off when the message **ACC ready to start** is not longer displayed, once the vehicle in front has moved off:

- Briefly depress the accelerator pedal (and gently lift the clutch pedal on vehicles with manual gearboxes).
- **OR:** press the **RES** button on the multifunction steering wheel.

The ACC does not remain active in the following cases:

- The stopping phase lasts for several minutes.
- When a vehicle door is opened.
- If the ignition is switched off.

⚠ WARNING

If the message **ACC ready to start** is displayed on the instrument cluster display and the vehicle in front moves off, your vehicle will move off automatically. In this case, any obstacles in the road may not be detected. This may cause serious accidents and injuries.

- **Always check the road before moving off, and apply the vehicle brakes yourself if necessary.**

ACC system limitations

The limits of the ACC system mean that it is not appropriate in all situations »» **⚠ in Introduction on page 186.**

SEAT does not recommend using the function in the following cases »» **⚠:**

- Heavy rain, snow or fog.
- When going through tunnels.
- On stretches of road with roadworks.
- On routes with curves, e.g. on mountain roads.
- On off-road routes.
- In covered car parks.
- On roads with embedded metal objects such as train or tram tracks.
- On roads with loose gravel.

Pay special attention when using ACC in the following situations:

On curves

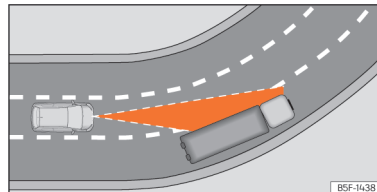


Fig. 138 Vehicle on a bend.

The ACC may not detect the vehicle in front on a curve, or may regulate the distance from vehicles in other lanes »» **Fig. 138.**

Vehicles outside the sensor zone

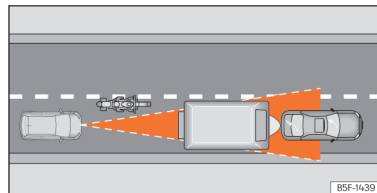


Fig. 139 Motorcyclist ahead out of range of the radar sensor.

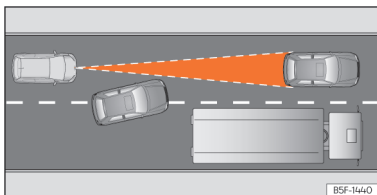


Fig. 140 Vehicle changing lanes.

In the following situations the ACC may not react, or may react slowly or inappropriately:

- Vehicles that are not aligned while driving or that are outside the sensor's detection area, such as motorcycles >>> **Fig. 139**.
- Vehicles that move into your lane, a short distance from your vehicle >>> **Fig. 140**.
- Vehicles with loads or accessories that protrude from the sides, rear or roof.

Objects that are not detected

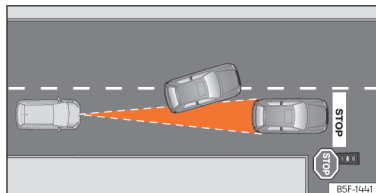


Fig. 141 A vehicle turning and another stationary.

The ACC function only detects and reacts to vehicles moving in the same direction. Therefore it does not detect:

- People
- Animals
- Vehicles travelling in the opposite direction or crossing the road.
- Other stationary obstacles

The ACC may not react to stationary vehicles. If, for example, a vehicle detected by the ACC turns or moves over and there is a stationary vehicle in front of it, the ACC will not react to the second vehicle >>> **Fig. 141**.

⚠ WARNING

Using the ACC in the above situations can cause serious accidents and injuries, and you could break the law.

Troubleshooting

⚠ ACC not available

The indicator lamp lights up yellow:

- The radar sensor is dirty or adjusted incorrectly. Take into account the warnings described at the beginning of this chapter >>> **page 178**
- There is a fault or a defect. Turn off the vehicle's ignition and turn it on again after a few minutes.
- If the problem persists, consult a specialised workshop.

The ACC does not work as expected

- Make sure that the conditions are met for the radar sensor to operate properly >>> **page 178**.
- If the brakes overheat, regulation stops automatically. Wait for them to cool down and check the operation again.
- Unusual noises during automatic ACC braking are normal and do not indicate any anomalies.

The following conditions may lead the ACC not to react:

- The accelerator or brake is depressed.
- No gear is engaged or the vehicle is in gear R.
- The vehicle is reversing.

- ESC is operating.
- The driver is not wearing his/her seat belt.
- The RPM is too high or too low.
- A vehicle brake light is faulty.
- A trailer brake light is faulty.
- The parking brake is applied.
- Driving on an excessive slope.

Predictive speed adjustment

Introduction

The predictive speed adjustment adapts the speed to the speed limitations detected and to the road layout (curves, crossings, roundabouts, etc.).

Predictive speed adjustment is an additional function of the ACC »» page 185 and uses the traffic signal detection system »» page 28 and the navigation data of the infotainment system.

Predictive speed adjustment is available depending on the equipment, although not in all countries.

WARNING

The predictive speed adjustment smart technology cannot overcome the limits imposed by the laws of physics and it only works within the limits of the system. Never allow the enhanced convenience of this function induce you to take any risk that compromises safety. If used negligently or involuntarily, it may cause serious accidents and injuries. The system is not a replacement for driver awareness.

- Always adapt your speed to suit visibility, weather, road and traffic conditions.
- Always pay attention to traffic and always keep the vehicle environment in mind.
- Always be prepared to adjust the speed yourself. If the traffic sign recognition system is not working properly or the navigation data is not updated, the speed may change unexpectedly and suddenly or may not be suitable for the current traffic situation. In addition, the speed adjusted by the system may not suit your driving style.
- Always be prepared to adjust the speed yourself. If you drive without any active guided route, if you leave the route calculated by the navigation system or if the position of the vehicle cannot be determined correctly because the GPS does not provide accurate data, the speed may change unexpectedly and suddenly or may not adapt to the current traffic situation.
- Always use up to date navigation data.

- Always take into account the maximum permitted speed. In the case of speed limitations that are not included in the navigation data, the maximum permitted speed may be exceeded.

Note

Also note the information related to the ACC relevant to safety »» page 185.

Limitations of the predictive speed adjustment

In addition to the limitations of the road sign detection system »» page 28 and the limitations of the ACC, predictive speed adjustment has the following limitations inherent to the system:

- Predictive speed adjustment only recognises traffic signals that show a speed limitation. The predictive speed adjustment does not take into account, above all, the rules on priority of passage or traffic lights.
- Traffic signs that indirectly show a speed restriction, e.g. signs at the entrance to towns, are only recognised on the basis of navigation data.
- On roads that are not included in the navigation data, or that are included with little accuracy, predictive speed adjustment is not available.

- If a speed limitation is notified based on the navigation data without it being detected by the traffic signal detection system, the indicated speed will be adjusted to the speed that was saved the last time.
- Predictive speed adjustment is not available for speed limitations below approx. 20 km/h (approx. 15 mph). In this case, a relevant message is displayed on the instrument panel screen.

Activating the predictive speed adjustment

In the infotainment system, in the assist services menu, you can individually adjust the type of incident the vehicle should react to »» page 38:

- Response to road layout.
- Response to permitted speeds.

Driving with the predictive speed adjustment

- Connect the ACC »» page 186.
- Set the distance and speed.
- Activate the predictive speed adjustment.

As soon as the system recognises a speed limitation or a relevant road layout during the route, a warning will appear on the instrument panel display. This warning will indicate the reason and the speed to which the vehicle will adjust due to said limitation.



Adjustment due to a speed limitation.



Adjustment due to a road layout.

In the event of adjustment due to a speed limitation, the detected speed will be saved as the new desired speed. In the event of adjustment due to the road layout, the vehicle will accelerate again after leaving the reason for the adjustment behind and the speed will be adjustment to that which has been saved.

The speeds indicated for curves depend on the driving profile»» page 170.

Interrupting speed adjustment

- During the warning, press the button **RES**.
- During the regulation, press the button **SET**.

Adjust the announced speed

The announced speed can only be adjusted in the event of adjustment due to a speed limitation.

Multifunction steering wheel:

RES + 1 km/h (1 mph), only while the ACC is adjusting

SET - 1 km/h (1 mph), only while the ACC is adjusting

+ + 10 km/h (5 mph)

- - 10 km/h (5 mph)

If you adjust the indicated speed excessively, the predictive speed adjustment is interrupted.

Note

- When a speed limitation is recognised, the predictive speed adjustment also adapts the saved speed even if the ACC is switched off. However, it will not adjust.
- If the speed of travel considerably exceeds the speed limit detected by the traffic signal detection system, a relevant warning is displayed in the instrument panel display.
- In the event of joining a highway without speed limitation, the recommended speed is automatically saved as the desired speed. If a higher speed has previously been saved for a motorway without a speed limit, this is used instead of the recommended speed.

Troubleshooting

A message is displayed indicating that predictive speed adjustment is not currently available or not in your country.

- If this message is displayed for a long time and predictive speed adjustment is available in your country, contact a specialised workshop.

Note

Depending on the anomaly in question, additional information may be displayed in Vehicle status »» page 37.

emergency brake assistance system (Front Assist)

Introduction

The objective of the system is to prevent head-on collisions against objects that may be in the vehicle's path or minimise the consequences of such impacts.

The function is designed to avoid collisions against:

- Parked vehicles.
- Vehicles, pedestrians and cyclists that are travelling in the same lane and direction.
- Pedestrians and cyclists who transversely cross the vehicle path.

The Front Assist records the mentioned objects by means of a camera on the top of the windscreen and a radar sensor on the front of the vehicle »» page 178.

Depending on several factors and how critical the situation is, the system operates in a staggered manner.

First informing the driver, and if there is no or insufficient reaction, then activating an autonomous emergency braking or an evasive manoeuvre as indicated by the conditions that will be discussed in the following points.

The system can be cancelled if the accelerator pedal is pressed or the steering wheel is turned firmly.

Depending on the equipment and the country, the Front Assist also includes the following functions:

- Pedestrian protection »» page 194
- Cyclist protection »» page 194
- Dodge assist »» page 194
- Turn assist »» page 195

WARNING

- **Front Assist is a driving assistance function that can never replace the driver's attention.**
- **Front Assist cannot change the laws of physics or replace the driver in terms of keeping control of the vehicle and reacting to a possible emergency situation.**
- **Following a Front Assist emergency warning, pay immediate attention to the situation and try to avoid the collision where appropriate.**


Warning levels and brake assist



Fig. 142 On the instrument panel display: advance warning indications.

Front Assist is active from 5 km/h (3 mph). Depending on different conditions (vehicle speed, speed and type of object recognised, etc.), some of the stages described below are omitted to optimise the performance of the system.


Safety distance warning


If the system detects that you are driving too close to the vehicle in front, it will warn the driver with this indication on the instrument panel display .

The timing of the warning varies depending on driver behaviour, vehicle speed and relative speed between both.

The safety distance warning is active from approx. 65 km/h (40 mph).

Advance warning

If the system detects a possible collision with the vehicle in front, it alerts the driver by means of an audible warning and an indication on the instrument panel display  >>> Fig. 142.

The warning moment varies depending on the traffic situation and driver behaviour. At the same time, the vehicle will prepare for a possible emergency braking >>>  in *Introduction* on page 193.

When Front Assist is connected, the indications of other functions on the screen may be hidden.

Critical warning

If the driver fails to react to the **advance warning**, the system may actively intervene in the brakes and generate a brief jolt to warn the driver of the imminent danger of a collision.

Automatic braking

If the driver also fails to react to the **critical warning**, the system may initiate independent emergency braking by progressively increasing the braking in accordance with the criticality of the situation.

Driver emergency braking assistance system

If the driver, after the critical warning, starts braking but the system detects that the brake is not being applied with sufficient force, the braking intensity will be increased. This brake assist only occurs if the pedal is pressed firmly.

WARNING

- **The system cannot prevent a collision, although it can significantly minimise the consequences by reducing the speed and the force of the impact.**
- **When the Front Assist causes a braking, the brake pedal is "harder".**
- **Automatic interventions by the Front Assist on the brakes may be interrupted by pressing the accelerator or moving the steering wheel.**
- **The Front Assist may brake the vehicle until it stops completely. However, the brake system does not halt the vehicle permanently. Use the foot brake!**

Pedestrian and cyclist recognition

The system recognises pedestrians and cyclists who travel in the same lane and direction and pedestrians and cyclists who transversely cross the vehicle's path.

Pedestrian and cyclist recognition technology cannot exceed the physically prescribed limits and works exclusively within the system's limits. The responsibility for braking always depends on the driver.

The pedestrian and cyclist recognition can cause undesired warnings and braking interventions, e.g. with a hidden radar sensor or a dirty camera field of vision.

Be ready to take charge of the vehicle at any time.

The pedestrian and cyclist recognition operating speed range is lower than that of the Front Assist.

Dodge assist

Dodge assist helps the driver avoid an obstacle in critical conditions.

Once the Front Assist has activated a critical warning, if the driver intends on dodging the object, the dodge assist will help correct the trajectory. The driver must start and finish the manoeuvre, as this is an assistance system and not an autonomous one.

The system is active between approximately 30 km/h (20 mph) and 150 km/h (90 mph).

Limitations

This system does not react to objects that cross transversely or to animals. The basic limitations of Front Assist should also be taken into account »» page 195.

Turn assist

Turn assist can avoid a collision with a vehicle approaching in the opposite direction, by braking the vehicle itself when the intention is to turn.

This system is active **up to 15 km/h** (9 mph).

Limitations

The turn-off assist function is available if you have indicated your intention to turn by activating the turn signal, you have turned the steering wheel and the turning path has started.

It only reacts to vehicles that are in the path of the vehicle (not to animals, people, etc.).

The basic limitations of the Front Assist must also be taken into account »» page 195.

System limitations



Fig. 143 On the instrument cluster screen: indication of the system's initial self-calibration.

Front Assist has certain limitations inherent to the system. Thus, in certain circumstances, some of the reactions may be inappropriate from the driver's standpoint. So pay attention in order to intervene if necessary.

The following conditions may cause the Front Assist not to react or to do so too late:

- In the first few instants of driving after switching on the ignition, due to the system's initial auto-calibration. During this phase, the instrument panel screen will display the following indication 🔄.

Unrecognised objects

- Vehicles travelling outside the reach of the sensors at close range from your own vehicle.
- Vehicles that suddenly change to the lane on which your vehicle is travelling.

- Pedestrians that cannot be recognised because they are partially or totally hidden.
- Objects such as walls, posts, fences, trees or garage doors.
- Loads and accessories of other vehicles that protrude over the sides, backwards or over the top.
- Other vehicles crossing the vehicle's path.
- In the case of pedestrians or cyclists standing or approaching in the opposite direction.

Operating limitations

In the following situations, the Front Assist may work late or in an undesirable manner. The following icon 🚦 is displayed on the instrument cluster, along with the message **Front Assist with limitations**.

- If the Front Assist or the front camera are disabled or broken.
- If the radar sensor or the front camera are dirty or covered.
- On taking tight bends or complex paths.
- When pressing the accelerator firmly or at full throttle.
- If the ESC is adjusting or is broken.
- If several brake lights of the vehicle or electrically connected trailer are damaged.
- If the vehicle is reversing.
- In case of snow or heavy rain.
- In case of dazzling sun or total darkness.

- Entrances and exits of tunnels.
- In complex driving situations (such as traffic islands, cut-through roundabouts, etc), Front Assist may issue warnings and intervene in braking in an unnecessary manner.

For more details, see section »» page 177.

Manual activation and deactivation of the function



Fig. 144 On the screen of the instrument panel Front Assist switched off message.


Front Assist indicators appear on the instrument panel display.

The Front Assist is active whenever the ignition is switched on. At the time of starting the ignition, the Front Assist may not be available for a short period of time while the system starts. During this phase, the instrument cluster screen will display the following indication »» Fig. 143.

When the Front Assist is disabled, so too are the advance warning and the distance warning functions. SEAT recommends leaving the Front Assist activated except in the situations presented in »» page 197.

Switching the Front Assist on and off


With the ignition switched on, the Front Assist can be deactivated or activated as follows:

- In the infotainment system: press the function button  > **Assistants > Smart Assistants > Front Assist** »» page 38.
- **OR:** Select the corresponding menu option using the button for the assistants systems »» page 177.

When Front Assist is disabled on the instrument cluster, the indication  will be displayed.

Each time the ignition is switched on, the Front Assist will reappear as active.

Activating or deactivating the pre-warning (advance warning)

The **advance warning** can be switched on or off in the infotainment system using the function button  > **Assistants > Smart Assistants > Front Assist** »» page 38.


The system will store the setting for the next time the ignition is switched on. SEAT recommends keeping advance warning active.

Depending on the vehicle's infotainment system the **advance warning** function may be adapted in the following modes:

- Advance
- Medium
- Delayed
- Deactivated

SEAT recommends driving with the function in "Medium" mode.


Switching distance warning on and off

The distance warning can be activated or deactivated in the infotainment system using the function button  > **Assistants > Smart Assistants > Front Assist** »» page 38.

The system will store the setting for the next time the ignition is switched on.

SEAT recommends having the safety distance warning activated except in the exceptions described in section »» page 197.

Activate or deactivate the dodge and turn assistant

The dodge and turn assistance systems can be activated or deactivated in the infotainment system using the function button  > **Assistants > Smart Assistants > Front Assist** »» page 38.

The system will store the setting for the next time the ignition is switched on.

SEAT recommends having the dodge and turn assistance systems activated except in the exceptions described in section »» page 197.

Deactivating Front Assist temporarily in the following situations

In the following situations the Front Assist should be deactivated due to the system's limitations:

- When the vehicle is to be towed.
- If the vehicle is on a test bed.
- If the radar sensor or the front camera are faulty.
- If the radar sensor or the front camera have suffered a violent blow.
- If it intervenes several times unnecessarily.
- If the radar sensor or the front camera are temporarily covered by an accessory.
- When the vehicle is going to be loaded onto transportation.
- If the windscreen is damaged in an area that covers the vision of the front camera.

Lane Assist system

Introduction

The Lane Assist System helps the driver stay in his/her lane within the physical limits of the system. This function is not suitable and is not designed to keep the vehicle automatically in the lane.

Using the camera located in the windscreen, the Lane Assist system detects the lane boundaries dividing the lanes in which the vehicle is travelling. If the vehicle gets too close to the detected lane limits, the system alerts the driver through a corrective motion of the steering wheel. The driver can cancel the steering corrective action at any time.

No warning is produced with the turn signals activated, given that the Lane Assist system understands that a lane change is required.

System limits

Use the Lane Assist system only on large, well-maintained motorways and highways.

The system is not available under the following conditions:

- The driving speed allowed is below approx. 60 km/h (35 mph).
- The system has not detected any lane lines.
- On tight bends.
- Temporarily in very sporty driving situations.
- If the turn signal is switched on before a manual lane change.
- If the driver firmly rectifies a system intervention.
- If a lane marking is crossed despite system intervention.
- If the driver does not react to a request to intervene.

WARNING

The intelligent technology in the Lane Assist system cannot change the limits imposed by the laws of physics and by the very nature of the system. Careless or uncontrolled use of the Lane Assist system may cause accidents and injury. The system is not a replacement for driver awareness or manoeuvres when driving.

- Always adapt your speed and the distance to the vehicles ahead in line with visibility, weather conditions, the condition of the road and the traffic situation.
- Always keep your hands on the steering wheel so it can be turned at any time. The responsibility of staying in the lane is always the driver's.
- The Lane Assist system does not detect all road markings. The road surfaces, road structures or objects in poor condition can be incorrectly detected as road markings under certain circumstances by the Lane Assist system. Immediately counter any unwanted intervention of the system.
- Please observe the indications on the instrument panel and act as is necessary if the traffic situation permits.
- In the following situations there may be undesired interventions of the system or it may be that the system does not intervene at all. In these situations, special attention is

required from the driver and, where appropriate, the temporary deactivation of the lane assist warning system:

- In very sporty driving situations.
- In adverse weather conditions and roads in poor condition.
- When passing through areas undergoing works.
- Before gradient changes of grade and river beds.
- Always observe the vehicle surroundings carefully and drive proactively.
- When the area of vision of the camera becomes dirty, covered or is damaged, the Lane Assist system function can be affected.

Driving with the Lane Assist System

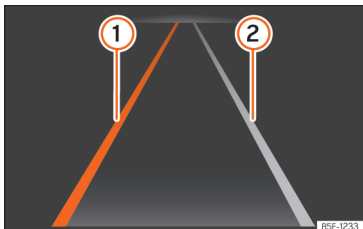


Fig. 145 On the instrument cluster screen: indications of the lane assist system.

- ① Yellow line: The system intervenes assisting on the represented side.
- ② White line: Lane line detected. The system does not intervene.

Depending on the equipment, additional details of the lane marking line currently detected by the camera, e.g. dashed road markings, can also be displayed on the instrument cluster screen.

Indicator lamps



It lights up grey

Lane departure warning system switched to passive and not available for guidance.



Lights up green

Lane Assist system active and available.



Lights up yellow

The Lane Assist system intervening with a rectification of the steering.

Switching the lane assist system on or off

In some countries, the Lane Assist system is always activated when the ignition is switched on. The connection status is shown in the **Driver assistance** menu of the Infotainment system or the driver assistance systems menu after pressing the corresponding button. These menus can be used to activate and deactivate the system.

The Lane Assist system is designed to actively intervene as of approximately 65 km/h (40 mph) and if it has detected the lane boundaries (system status: active).

When you activate a turn signal, the system temporarily goes into a passive state in order to allow manual lane change.

An energetic rotation or rectification of the steering wheel by the driver causes the system to temporarily switch to a passive state.



When Lane Assist is switched off, the yellow disconnection warning lamp lights up in the instrument cluster (depending on the country).



Note

If a system fault persists, Lane Assist may switch off automatically.

Driver intervention prompt

If the steering is not corrected manually, the system prompts the driver through an indication on the instrument panel display and acoustic warnings.

If no reaction is obtained from the driver, the system switches to a passive state.

Regardless of the steering manoeuvres, through an indication on the instrument panel display and acoustic warnings, the driver is also prompted to drive through the centre of the lane if the steering correction lasts more than reasonable.

Steering wheel vibration

The following situations may result in a steering wheel vibration:

- The lane ceases to be recognised during a sudden intervention in the direction of the system.

It is also possible to select steering wheel vibration in the **Assistants** menu of the infotainment system. In this case, when a vehicle with Lane Assist switched on crosses over a detected lane marking, the steering wheel will vibrate.

Troubleshooting

The lane departure warning assistant is not available

The control lamp switches on yellow. A relevant warning is also displayed on the instrument panel screen.

- The field of vision of the camera is dirty. Clean the windscreen >>> page 365.
- The visibility of the camera is diminished due to accessories or adhesives.
- There is a fault or a defect. Switch the engine off and on again.

The system behaves differently than expected

- The camera has been altered or damaged, e.g. because of damage caused to the windscreen. Check for visible damage.
- Do not mount objects on the steering wheel.

If the problem persists, consult a specialised workshop.

Note

After switching on the ignition, it may take a few seconds before a fault is detected in the system.

Note

If lane assist is not available, Emergency Assist and Travel Assist are not available either.


Driving Assist (Travel Assist)

Introduction

Travel Assist combines adaptive cruise control (ACC) and the adaptive lane guidance function. Within the limitations of the system, the vehicle can maintain a distance from the vehicle in front that is preselected by the driver and remain in the preferred position within the lane.

Travel Assist uses the same sensors as Adaptive Cruise Control (ACC) and Lane Assist. Therefore, carefully read the information about the ACC >>> page 185 and the Lane Assist >>> page 197 and take into account the limitations of the systems and the indications given in the information.

How to know if the vehicle is fitted with Travel Assist

The vehicle is fitted with Travel Assist if the Travel Assist option appears when the button  on the multifunction steering wheel is pressed.

Speed range

Depending on the type of gear, Travel Assist regulates from 0 km/h (0 mph). The speed can be set from 30 km/h (20 mph).

Driving with Travel Assist

Travel Assist automatically controls the accelerator pedal, the brakes and the steering. In addition, Travel Assist may, within its limitations, decelerate the vehicle until it stops behind another that stops and automatically starts again. You can override assisted adjustment at all times.

Status display

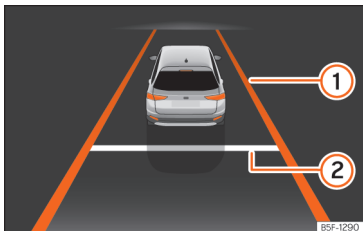





Fig. 146 On the instrument cluster display: display of active regulation (schematic representation).

- ① The colour of the lane markings indicates the status of the adaptive lane guidance function.
 - *Green*: adaptive lane guidance function active.
 - *Grey*: passive adaptive lane guidance function.

- ② Distance set.
Depending on the equipment, additional details, e. g. dashed road markings and vehicles in front, can also be shown on the instrument cluster display.

Control lamps indicate the status of the system on the instrument panel display:

-  Indicator lamp green: Travel Assist active, adaptive cruise control and adaptive lane guidance function are active.
-  Partially green lamp: Travel Assist active, adaptive cruise control active and adaptive lane guidance function passive.
-  Grey lamp: Travel Assist deactivated, not regulating.

Driver intervention prompt

If you remove your hands from the steering wheel, after a few seconds the system asks you to take over the steering with an indication on the instrument panel display and acoustic warnings.

If you do not react, Travel Assist is deactivated. Depending on the equipment, Emergency Assist activates if it is activated in the infotainment system.

WARNING

The Travel Assist smart technology cannot overcome the limits imposed by the laws of physics and it only works within the limits of the system. If Travel assist is used negligently or involuntarily, it may cause serious accidents and injuries. The system is not a replacement for driver awareness.

- Bear in mind the system limitations and the indications regarding the control of the Adaptive Cruise Control (ACC) and Lane Assist.
- Adapt your speed and safety distance to the vehicle in front of you at all times to suit visibility, weather, road and traffic conditions.
- Do not use Travel Assist when visibility is bad, on steep roads, on windy roads or in slippery circumstances (e. g., snow, ice, rain or loose gravel), or on flooded roads.
- Do not use Travel Assist offroad or on roads where the surface is not firm. Travel Assist has been designed for use on paved roads only.
- Travel Assist does not react to people or animal or vehicles crossing your path or which approach you head-on in the same lane.
- Brake immediately if Travel Assist does not slow down enough.
- Brake immediately when instructed to do so on the instrument cluster display, or if Travel Assist does not reduce speed sufficiently.
- Brake when the vehicle continues to move forward without it being desired after an indication to brake.
- If possible, do not wear gloves while driving. The system could interpret this as no driving activity.

- If driver intervention is requested on the instrument panel display, immediately resume control of the vehicle.
- Keep your hands on the steering wheel at all times, to ensure you have control over the steering at all times. The driver is always responsible for keeping the vehicle in its own lane.
- Always be prepared to adjust the speed yourself.

Operating Travel Assist

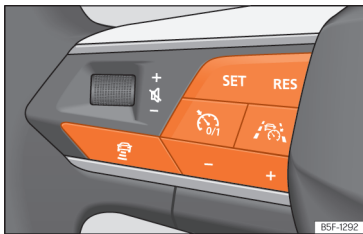



Fig. 147 Left side of the multifunction steering wheel

Switch on and start regulation

1. While driving with ACC activated, press  on the multifunction steering wheel.
The vehicle switches from ACC to Travel Assist.

Depending on the driving situation, the vehicle switches to the following system statuses in Travel Assist:

- When ACC is regulating, Travel Assist maintains the current speed and the preset distance to the vehicle in front.

When lane markings are detected, the vehicle is also kept in the lane by steering movements.


- If ACC is not regulating, Travel Assist remains selected but in a passive (unregulated) status.

1. Press the **SET** button.

Travel Assist switches to the active system status, depending on the driving situation.

The indicator lamp for the driving situation lights up on the instrument cluster display. A message is also displayed.

Interrupting the adjustment

1. Briefly press the button .

OR: press the brake pedal.

The set distance remains saved.

Switch to ACC

1. Press the  button on the multi-function steering wheel.

The vehicle switches from Travel Assist to the ACC system status corresponding to the driving situation.

Making other adjustments

All other aspects of Travel Assist are controlled like the ACC.

Using the lane change assist

Lane Change Assist uses the same sensor system as Side Assist. Therefore, read the information on Side Assist **>>> page 205** carefully and observe the limits of the system and the notes that it displays.

Activating the convenience turn signal on a motorway, provided that the prerequisites are met and no vehicles have been detected in the vicinity, provides assistance when the vehicle is changing lanes.

Prerequisites

Lane change assist is only available, depending on the vehicle's equipment, when driving forwards on multi-lane motorways included in the Infotainment system's navigation data, and when travelling faster than 90 km/h.

Travel Assist must also be activated.

Status display

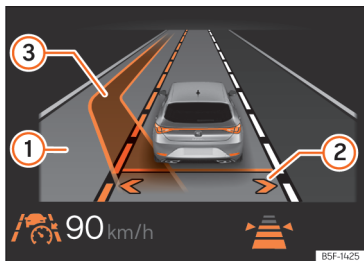


Fig. 148 On the instrument cluster screen: lane change assist display (schematic representation).

- ① Adjoining lane highlighted, changing lanes is possible on the respective side.
- ② Arrows in the vehicle's own lane show that a lane change is available.
- ③ Yellow wake on the overtaking lane. The lane change is in progress.

According to the driving situation, the following symbols also light up in the instrument cluster:

- ☞ Lane assist active, manoeuvre not available.
- ☞ Lane assist active, manoeuvre available (arrow direction highlighted).

Activating and deactivating lane change assist

You can activate and deactivate lane change assist in the Infotainment system.

1. Access the assistant menu.
2. Select Travel Assist.
3. Activate or deactivate lane change assist as a sub-function of Travel Assist.

Note

If a fault occurs in the system, the lane change assist may automatically switch off or be interrupted during the lane change.

Activating lane change assist while driving

Once the prerequisites have been met and the programmed speed has been set with the button **SET**.

1. Press the **SET** button again.

This activates the lane assist. The arrows of your own lane on the instrument cluster display are grey »» Fig. 148 ②

Changing lanes

If the system detects no objects in the detection field of the sensor system and an assisted lane change to an adjacent lane is possible, the corresponding lane is shown in the instrument cluster display next to the driver's own lane.

1. When the convenience turn signal is activated on the desired side, the vehicle changes lane. A message is also displayed.


When changing lanes, the vehicle automatically activates the turn signal on the corresponding side. Once the lane change is complete, the turn signal automatically switches off.

WARNING

The sensor system cannot reliably detect all objects in the surroundings and operates exclusively within the limits of the system. If you use the lane change assist irresponsibly, accidents and serious injuries can occur. The system is not a replacement for driver awareness.

- Before changing lanes, make sure it is safe to do so. In particular, rapidly approaching objects may not be detected in time.
- Keep your hands on the steering wheel at all times and be prepared to control your own speed and direction of travel.

Turning off the lane change assist

- It turns off if the steering wheel is turned sharply.
 - **OR**: by pressing the button .
 - **OR**: by pressing the brake pedal.
- Lane change assist is deactivated.

Troubleshooting

Travel Assist is not available or does not work as expected

The control lamp switches on yellow. A relevant warning is also displayed on the instrument panel screen.

- There is a fault in the sensors. Check the causes and solutions described in the information about the ACC **>>> page 190** or the Lane Assist **>>> page 199**.
- There is a fault or a defect. Switch the engine off and on again.
- The system limits are exceeded.
- If the problem persists, consult a specialised workshop. SEAT recommends visiting a SEAT dealership.

Grip the steering wheel

The warning lamp lights up white and a message is then shown on the instrument cluster screen.

- You released the steering wheel for a few seconds. Take hold of the steering wheel and take control of the vehicle.

Grip the steering wheel

The warning lamp lights up red and a message is shown on the instrument cluster display. Depending on the situation, an audio warning sounds or the steering wheel vibrates.

- You have let go of the steering wheel for a long time, or the system limits have been reached. Immediately take hold of the steering wheel and take control of the vehicle.

Travel Assist disconnects automatically

• *Vehicles without Emergency Assist:*

You have released the steering wheel for a long period.

- There is a fault or a defect. Switch the engine off and on again.
- If the problem persists, consult a specialised workshop. SEAT recommends visiting a SEAT dealership.

The adjustment is interrupted unexpectedly

• *Vehicles without lane departure warning:*

You have turned on the turn signal.

Lane change assist is interrupted or unavailable

A message about this is shown on the instrument cluster display.

- The vehicle has stopped detecting lane markings.
- You have let go of the steering wheel
- You are applying too much force to the steering wheel.
- You have turned on the turn signal too many times, or the turn signal lever is stuck.

- The driving speed is lower than around 85 km/h.
- The vehicle has detected objects in the vicinity that prevent an assisted lane change.
- You are not on a multi-lane motorway.

Emergency Assist

How it works

Emergency Assist can detect whether there is inactivity by the driver and can automatically keep the car in its lane and stop it altogether if necessary. This way the system can actively help avoid an accident or reduce its consequences.

Emergency Assist uses the same sensors as Adaptive Cruise Control (ACC) and Lane Assist. Therefore, carefully read the information about the ACC **>>> page 185** and Lane Assist **>>> page 197** and take into account the limitations of the systems and the indications given in the information.

Driver intervention prompt

If the emergency assist detects that the driver is not actively doing anything, he or she is prompted to take control of the vehicle by audio warnings and a brief application of the brake. In addition, a warning is shown on the instrument cluster display and the volume of the infotainment system is lowered.

Depending on the equipment, the driver's seat belt is tightened at the same time.

System intervention

If the driver does not react, the system can brake the vehicle and keep it in its lane. The following control lamp lights up on the instrument cluster display:



The system is regulating, lane guidance is activated.



The system is regulating, passive lane guidance.

You can cancel the adjustment at any time by moving the steering wheel, over-accelerating or braking.

While the emergency assistant is in operation, other road users are warned as follows:

- The hazard warning lights are switched on soon after.
- The horn sounds (depending on the speed).

The following happens as soon as the vehicle stops:

- The electronic parking brake and gear shift position **P** are engaged.
- All doors are unlocked.
- The interior lighting comes on.
- Depending on the features, an emergency call (eCall) is made.

Connecting and disconnecting

Emergency Assist can be switched on and off in the assistants menu of the infotainment system.

When connected, the Emergency Assist is only activated if the following requirements are met:

- The Travel Assist or the Lane Assist are switched on.
- The system has detected a road lane marking on both sides of the vehicle.

Note

If the emergency assist is faulty, it may switch off automatically.

Note

If Lane Assist is unavailable, Emergency Assist will be unavailable as well.

WARNING

The smart technology fitted into the Emergency Assist cannot overcome the limits imposed by the laws of physics; it only works within the limits of the system. The driver is responsible for driving the vehicle.

- Adapt your speed and safety distance to the vehicle in front of you at all times to suit the visibility, weather, road and traffic conditions.
- The Emergency Assist cannot always avoid accidents or serious injuries by itself.

- If the radar sensor or the camera are covered or have been altered or damaged, the system may intervene on the brakes or on the direction in an inappropriate manner.

- The Emergency Assist does not react to people or animal or vehicles crossing your path or which approach you head-on in the same lane.

WARNING

If the Emergency Assist Intervenes inopportunistically, serious accidents and injuries may occur.

- If the vehicle behaves differently than expected, interrupt the intervention of the Emergency Assist by over-accelerating, braking or moving the steering wheel.
- Do not use Travel Assist or Lane Assist. Have the system checked by a specialised workshop.

Troubleshooting



Emergency assist is not available

The control lamp switches on yellow. A relevant warning is also displayed on the instrument panel screen.

- There is a fault or a defect. Turn the drive system off and on again.
- If the problem persists, switch off the Emergency Assist and go to a specialised workshop.

The buttons react differently than expected

Moisture, dirt and grease can limit the operation of the buttons.

- Make sure the buttons are always clean and dry.

Lane departure warning (Side Assist)

Introduction

The lane departure warning uses radar sensors to monitor the areas behind the vehicle »» page 6, »» page 7. The system does this by measuring the vehicle's distance from other vehicles and its speed differential. The lane departure warning will not work at speeds of less than approx. 15 km/h (9 mph).

The lane width is not detected individually, but is rather pre-configured in the system. Thus if you are driving in wide lanes or in between two lanes, the indications may be incorrect. Furthermore, the system can detect vehicles driving in the lane next to you (if there are any), and can also detect stationary objects such as dividers, and thus give an incorrect indication.

Trailer mode

Side assist is automatically deactivated and cannot be switched on if the factory-fitted tow-bar is electrically connected to a trailer or similar device.

As soon as the driver starts to drive with a trailer connected electrically to the vehicle, a message is displayed on the instrument panel display indicating that side assist is switched off. Once the vehicle trailer has been disengaged, side assist will return to the initial state prior to the moment the trailer was electrically connected.

If the tow-bar is not factory fitted, side assist should be switched off manually when driving with a trailer.

Physical limitations inherent to the system

In some situations the lane departure warning may not interpret the traffic situation correctly. I.e. in the following situations:

- on tight bends;
- in the case of lanes with different widths;
- in areas with significant gradient changes;
- in adverse weather conditions;
- in the case of special constructions to the side of the vehicle, e.g., high or irregular dividers.

WARNING

The smart technology incorporated into Side Assist cannot overcome the limits imposed by the laws of physics; it only works within the limits of the system. Accidents and severe injury may occur if Side Assist is used negligently or involuntarily. The system is not a replacement for driver awareness.

- Adapt your speed and safe distance to the vehicle in front of you at all times to suit visibility, weather, road and traffic conditions.
- Keep your hands on the wheel at all times to be ready to intervene in the steering at any time.
- Pay attention to the indicator lamps that may come on in the external rear view mirrors and on the instrument cluster, and follow any instructions they may give.
- The lane departure warning could react to any special constructions that might be present to the sides of the vehicle, e.g. high or irregular dividers. This may cause erroneous warnings.
- Never use the lane departure warning on unpaved roads. The lane departure warning has been designed for use on paved roads.
- Always pay attention to the vehicle's surroundings.
- The control lamps of the lane departure warning may have limited functionality due to solar radiation.

Note

If Side Assist does not work as described in this chapter, stop using it and contact a specialised workshop.

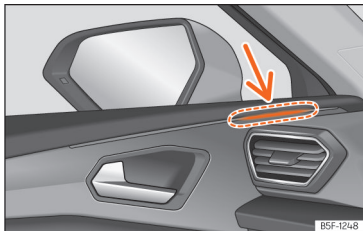
Driving with Side Assist

Fig. 149 Control lamp of the lane departure warning.

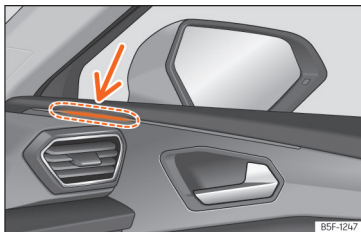


Fig. 150 Control lamp of the lane departure warning.

Connecting and disconnecting

Side Assist can be switched on and off by accessing the **Assistants** menu in the infotainment system.

Additionally it can be switched on and off by accessing the **Assistants** menu on the instrument cluster.

When the lane departure warning is ready to operate, the indications in the control lamps will turn on briefly as confirmation.

When the vehicle is restarted, the last adjustment in the system will remain active.

Light indication

The control lamp provides an indication on the corresponding side regarding the traffic situation behind the vehicle, if it is deemed to be critical. The control lamp on the left-hand side indicates the traffic situation to the rear left of

the vehicle, and the control lamp on the right-hand side indicates the traffic situation to the rear right of the vehicle.

Keep the warning lamps zone of the lane departure warning free of objects, adhesives or the likes that may interfere with your visibility.

It lights up

It turns on once briefly: the lane departure warning is activated and ready to operate, i.e. when activating the system.

It lights up continuously: the lane departure warning has detected a vehicle in the blind spot.

Flashes

A vehicle has been detected in the adjacent lane and the turn signal has been engaged in the direction of the detected vehicle.

For vehicles that are also equipped with Lane Assist **>>> page 197**, a warning to switch lanes will also appear even though the turn signal has not been engaged [Lane Assist "Plus"].

The control lamps light up when the ignition is switched on and should turn off after approximately 2 seconds. This is the time taken for the function check.

If there are no indications from the control lamp of the lane departure warning, this means that the lane departure warning has not detected any other vehicles at the rear area.

When the exterior lighting is low, the intensity with which the control lamps come on is dimmed. The user can modify the intensity of the control lamps with up to 5 levels in the infotainment system menu.

Lane assist Plus.

The Lane Assist Plus function can be used by activating the **Lane Assist** »» page 197 and **Side Assist** functions. In this case its functions are expanded as described below.

If the driver initiates a lane change manoeuvre in a potential critical situation:

- The lamp flashes in the corresponding rear-view mirror even though the turn signal has not been activated.
- The steering wheel vibrates to warn the driver of the risk of collision.
- torque is applied to correct the steering and return the vehicle to its lane.

Driving situations

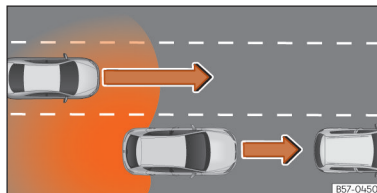


Fig. 151 Overtaking with traffic behind the vehicle.

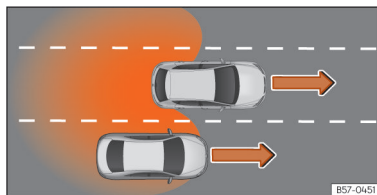


Fig. 152 Overtaking in the central lane and then joining the right lane.

In the following situations, an indication will be displayed by the control lamp »» **Fig. 149** , »» **Fig. 150** (arrow):

- When being overtaken by another vehicle »» **Fig. 151**.
- When overtaking another vehicle »» **Fig. 152** with a speed difference of approx. 10 km/h (6 mph). If the vehicle is passing at a considerably higher speed, no indication will be displayed.

The faster the vehicle approaches, the sooner an indication will be displayed in the control lamp, because the lane departure warning takes into account the speed differential with other vehicles. Thus even though the distance from the other vehicle is identical, the indication will appear sooner in some cases and later in others.

Parking and manoeuvring

Park the vehicle

Parking

When parking your vehicle, all legal requirements should be observed.

1. Connect the electronic parking brake
»» page 209.
2. *Automatic transmission:* switch on the parking lock by pressing button **P**.
3. Stop the engine and turn off the ignition. Turn the steering wheel slightly to engage the steering lock.
4. *Manual gearbox:* engage first gear on flat ground and slopes, or even reverse gear on hills, and release the clutch pedal.
5. On slopes, turn the steering wheel so that if the parked vehicle were to start moving, it would steer toward the kerb.
6. Exit the vehicle »» ⚠. Watch out for other road users!
7. Take all vehicle keys with you and lock it.

To avoid damage or hazardous situations, always park the vehicle on a suitable parking surface »» ⓪.

⚠ WARNING

If the vehicle is parked incorrectly, it could roll away, even on gentle slopes. This can cause accidents and serious injuries.

- When parking, always carry out the operations in the stipulated order.
- Before leaving the vehicle, make sure that the electronic parking brake is engaged.

⚠ WARNING

If children, people who may need assistance or animals are left unattended in the vehicle, accidents and serious injuries can occur.

- Never leave children, people who may need assistance or animals unattended in the vehicle. They could operate the gear selector and release the electronic parking brake. The vehicle could be set in motion.
- Never leave children, people who may need assistance, or animals in the vehicle. Depending on the season, very high or low temperatures can be reached inside a closed vehicle.
- Always take all vehicle keys with you when leaving the vehicle.

ⓘ NOTICE

The presence of irregularities on the ground, sand or mud can cause damage to the vehicle and mean that it cannot be parked properly.

- Always park the vehicle on firm and flat ground.

ⓘ NOTICE

Components on the underside of the vehicle, such as bumpers, spoilers and running gear components, can be damaged when running over objects protruding from the ground.

- Drive carefully when entering buildings, on ramps, driving over kerbs or fixed markings, and on descents.

ⓘ NOTICE

Avoid parking the vehicle where the hot exhaust system could ignite inflammable materials, such as dry grass, low bushes, spilt fuel or flammable materials.

Electronic parking brake

Using the electronic parking brake



Fig. 153 Centre console, lower part: electronic parking brake button.

Connecting

The electronic parking brake can be activated whenever the vehicle is at a standstill, even when the ignition is switched off. Activate it whenever you leave or park the vehicle.

- Pull and hold the **Fig. 153** button.

The parking brake is on when the red indicator lamp turns on on the instrument cluster and the button indicator lamp turns on.

- Release the button.

Switching off

- Switch the ignition on.
- Press the button **Fig. 153**. At the same time step hard on the brake pedal or, if the engine is running, press the accelerator pedal slightly.
- The indicator lamp on button and the red indicator lamp on the instrument cluster turn off.

Automatic disconnection when moving off

The electronic parking brake automatically disconnects when moving off in any of the following situations, if the driver's door is closed and the driver's seatbelt is buckled:

- *Vehicles with automatic gearboxes*: a gear is engaged or changed to another and the accelerator is pressed gently.

Vehicles with manual gearboxes: the clutch pedal is pressed fully before starting off and the accelerator is pressed gently.

- To facilitate certain manoeuvres, there are exceptions that allow the parking brake to disconnect automatically without the driver's seatbelt being buckled.

The parking brake can be prevented from being automatically released by continuously pulling up the switch when moving off.

The electronic parking brake is not disconnected until the button is released. This can facilitate starting off when a heavy load is towed **>>> page 294**.

Automatic application when leaving the vehicle improperly

In vehicles with automatic transmission, the electronic parking brake is activated automatically when exiting the vehicle incorrectly if:


- The gear selector is in the **D/S** or **R** or is in tiptronic mode.
- **AND**: the vehicle is stationary.
- **AND**: the driver door is open.

Automatic connection when the ignition is turned off

This function can be deactivated through the Infotainment system . In vehicles with manual transmission, the electronic parking brake is activated automatically when the ignition is turned off.


Emergency brake function

Only use the emergency brake function in an emergency, if the vehicle cannot be stopped by pressing the brake pedal **>>>**

- Pull and hold the  button. The vehicle will brake sharply. At the same time, an acoustic warning can be heard.
- To stop the braking process, release the button or press the accelerator.

WARNING

If the vehicle is left improperly, it could roll away. This could lead to accidents, serious injury and property damage.

- When parking the vehicle, always perform the appropriate operations in the indicated order >>> page 208, *Parking*.
- Before leaving the vehicle, make sure that the electronic parking brake is applied and that the control lamp  next to the gear selector is red on the instrument cluster.

WARNING


The improper use of the electronic parking brake can cause accidents and serious injury.

- Never use the electronic parking brake to stop the vehicle, unless it is an emergency. The braking distance is considerably longer. Always use the brake pedal.
- Never accelerate from the engine when a gear range or a gear is engaged and the engine is running. The vehicle could move, even if the electronic parking brake is activated.

NOTICE

To prevent the vehicle from unintentionally moving when parking it, first apply the electronic parking brake and then remove your foot from the brake pedal.

Troubleshooting

 There is a defect in the electronic parking brake

The control lamp switches on yellow.

Visit a SEAT dealer or other specialist workshop.

The electronic parking brake does not release.

The 12-volt battery is discharged.

- Use the jump start >>> page 315.

The electronic parking brake makes noises


- When the electronic parking brake is applied and released, noises may be heard.
- The system performs automatic and audible checks sporadically in the parked vehicle if some time elapses without the electronic parking brake being used.

Auto-Hold function



Fig. 154 In the lower part of the centre console: Auto Hold function button.


The Auto-Hold function holds the vehicle at a standstill and prevents it from moving without it being necessary to keep the brake pedal depressed.

AUTO HOLD When the Auto-Hold function is active, the control lamp on the instrument cluster lights up green. The control light of the  >>> Fig. 154 button remains on when the Auto Hold function is connected.

Requirements

- The driver's door is closed.
- The driver's seatbelt is buckled.
- The engine is running.

Connecting and disconnecting

Press the Auto Hold button >>> . The control lamp on the button turns on when the Auto Hold function is switched on. The function is now available to be activated. The control lamp on the button goes out when the Auto Hold function is switched off.

Switching on and off automatically

If the Auto Hold function was switched on via the Auto Hold button before switching the ignition off, the function will remain on the following time the ignition is switched on.

If the Auto Hold function was not switched on, it will remain off next time the ignition is switched on.

The Auto Hold function disconnects automatically if the following conditions are met:

1. If any of the requirements of the function are no longer met.
2. If the engine runs erratically or has any anomaly.
3. If the engine stalls.
4. *Automatic gearbox:* If any of the tyres have only minimal contact with the ground, e.g. For example, if the axles are crossed.

Activation and deactivation

The Auto Hold function activates automatically if the following conditions are met (all points must be met **at the same time**):

1. The function is switched on
2. The vehicle is brought to a complete standstill with the brake pedal on a flat surface or on a slope.
3. The engine rotates "correctly".

The Auto Hold function deactivates automatically if the following conditions are met:

1. The car moves off again:

Automatic gearbox: by pressing the accelerator.

Manual gearbox: by lifting your foot off the clutch pedal and pressing the accelerator (provided that a gear is engaged).

2. The function is switched off with the actions seen in the previous sections.

WARNING

The smart technology of the Auto-Hold cannot overcome the limits imposed by the laws of physics and it only operates within the limits of the system. Never allow the enhanced convenience of the Auto-Hold function to induce you to take any risk that compromises safety.

- Never leave the vehicle running with the Auto Hold function switched on.
- The Auto-Hold cannot always keep the vehicle stopped on an uphill, or brake it sufficiently on a downhill, e.g. on slippery or icy surfaces.

NOTICE

Always deactivate the Auto-Hold function before entering an automatic car wash facility. Failure to do so could cause damage due to the automatic application of the parking brake.

Note

After connecting the 12-volt battery, drive for a short distance to reset the Auto Hold function to operate correctly.

General information on parking systems

Automatic brake operation

The automatic braking feature of a parking system is used to reduce the danger of collision when an obstacle is detected during a parking manoeuvre.

Braking functions

Depending on the equipment, the following systems are available:

- Park assist plus manoeuvre braking function »» page 213.
- Rear cross traffic alert emergency brake function »» page 227.
- Assisted parking assistant emergency brake function »» page 217.

Infotainment system lamps



White lamp: system activated, the system brakes when it detects an obstacle in the path.



Coloured lamp: system deactivated, the system does not brake when it detects an obstacle although the sensors still detect it.

Requirements

- The vehicle is moving between approx. 3 km/h and 8 km/h when manoeuvring
- A parking system is switched on.

The brakes are not automatically operated when park assist is switched on automatically while moving forward.


What happens in the event of automatic braking?

If there is an obstacle, the system brakes the vehicle to a standstill and keeps it stationary for approx. 2 seconds. **Press the brake!**

Activate

- Automatic braking is activated when the driver switches a parking system on.

Deactivating

- The automatic brake operation function deactivates when a park assist system is switched off.
- **OR:** to temporarily deactivate the manoeuvre braking function, press the  function button on the park assist screen and change the setting.

WARNING

Never allow the automatic braking operations of park assist systems to lead you to take any risk that compromises safety. In certain situations, the automatic braking intervention may only work in a limited way or not work at all. Collisions with obstacles can injure people and damage the vehicle. The system is not a replacement for driver awareness.

- Pay attention and do not rely solely on park assist systems.
- Always be prepared to brake and control the steering yourself.
- Do not take any risks that compromise safety.
- Act in accordance with the warnings and driving recommendations of the parking systems.

Note

- Switch off the parking system if the automatic brakes operate excessively, e.g. when driving off-road.
- After the park assist's manoeuvre braking function has braked the vehicle, driving in the same direction for 5 metres is deactivated, and becomes active again after changing gear or changing the position of the gear selector.

Troubleshooting

The parking system behaves differently than expected

There can be several causes:

- The system requirements are not met.
- The sensors or the camera are dirty or have ice on them »» page 366.

- The camera lens is not clean and the camera image is not clear >>> page 366.
- Some noise sources, such as a jackhammer or a cobblestone surface can interfere with the ultrasound signal.
- The vehicle has some type of damage in the sensor or camera area, e.g. due to a parking impact.
- The sensor detection zone or field of view of the camera are blocked by an accessory, e.g. a bike rack.
- Changes have been made to the paintwork or structural modifications in the sensor or camera area, e.g. at the front of the vehicle or to the running gear.

Also take into account the messages displayed on the infotainment system screen.

Sensor or camera without visibility, or the parking system has been switched off

If a sensor fails, that sensor zone is permanently switched off. The affected sensor zone may be displayed on the infotainment system with a ! symbol and a greyed-out graphic segment. If necessary, the parking system switches off the affected zone.

If the park assist is not working properly, a continuous audio signal sounds for a few seconds when it is switched on. If applicable, a message to this effect is displayed on the instrument cluster screen

- Check if one of the causes indicated above has occurred.
- Once the source of the problem has been eliminated, the system may be reconnected.
- If the problem persists, consult a specialised workshop.

Park Distance Control Plus (Park Pilot)

Description

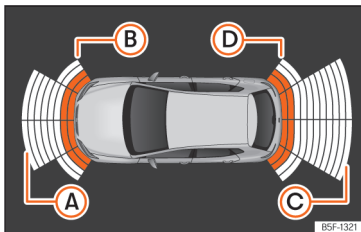


Fig. 155 Parking aid view on the Infotainment system display.

Parking aid plus assists the driver by giving visual and audio warnings about obstacles detected in front of and behind the vehicle.

The bumpers are fitted with sensors. When an obstacle is detected, it is indicated by audible signals and in the Infotainment system >>> **Fig. 155**.

When moving close to an obstacle, it is possible to know if the obstacle is in front of the vehicle or behind it according to the sound frequency.

The approximate measurement range of the sensors is:

- A** 1.20 m
- B** 0.90 m
- C** 1.60 m
- D** 0.90 m


As you approach the obstacle, the frequency of the audible signals will increase. The signal will sound continuously at around 0.30 m: Stop the vehicle!

If the separation is maintained, the warning volume is reduced after about 2.5 seconds.

Error messages



If an error or fault message is displayed on the instrument cluster in Park Assist, there is a fault.

If the fault doesn't disappear before disconnecting the ignition, it will not be indicated next time the parking aid is connected.

If a rear sensor is faulty, only the obstacles in the front area are detected. If a front sensor is faulty, only the obstacles in the rear area are displayed. The symbol  is displayed.


We recommend taking the vehicle to a specialised workshop to have the fault repaired.

Trailer mode

On vehicles with a factory-mounted trailer hook, when the trailer is connected, the rear sensors will not activate when reverse gear is engaged or button  is pressed in the Infotainment system ( > **Assistants**). Therefore, any objects behind or to the side of the vehicle will not be indicated on the screen and no audio signals will sound.

The screen will only display objects detected at the front, and the vehicle's trajectory will be hidden.

Parking assist settings

The indications and audible signals are set in the Infotainment system: function button  > **Assistants** > **Parking** > **P** > **Settings**.

- **Automatic activation:** On/off
- **Front volume:** Volume in the front and rear area.
- **Rear volume:** Volume in the rear area.
- **Reduce volume:** When the parking aid is switched on, the volume of the audio source will be reduced, depending on the selected option.

WARNING

- Always pay attention, by looking directly, to traffic and the area around the vehicle. Assistance systems are not a replacement for driver awareness. Responsibility always lies with the driver.
- The sensors have blind spots in which obstacles and people are not detected. Pay special attention to children and animals.
- Always keep visual control of the surroundings: use the mirrors for additional help.

NOTICE

Park assist plus functions can be affected by various factors which may cause damage:

- Under certain circumstances, the system does not detect or display certain objects:
 - Chains, trailer draw bars, bars, fences, posts and thin trees.
 - Objects that are located above the sensors, such as protrusions in a wall.
 - Objects with certain surfaces or structures, such as wire mesh fences or powder snow.
- Certain surfaces of objects and garments do not reflect the ultrasound sensors' signals. The system cannot detect these objects or people wearing such clothes correctly.

- Sensor signals may be affected by external sound sources. This may prevent them from detecting people or objects.
- If the system warns you of the proximity of a low obstacle, please note that after being detected by the system, the obstacle in question may disappear from the measurement sensors as the vehicle moves closer, and the system will no longer warn of its presence. In certain circumstances, objects such as high kerbs that could damage the underside of the vehicle are not detected.
- If the parking distance warning system is ignored, the vehicle could suffer considerable damage.
- Damage to the radiator grille, bumper, wheel arch and vehicle underbody can modify the orientation of the sensors. This can affect the parking aid function. Have the function checked by a specialised workshop.
- A number plate or number plate holder with dimensions that exceed the space for the number plate, or a cured or deformed number plate can cause false detections or a loss of visibility for the sensors.

Note

- The display on the Infotainment system screen shows a slight time delay.
- In certain situations, the system can give a warning even though there is no obstacle in the detected area:
 - Rough or cobbled surfaces or surfaces with long grass.
 - External ultrasound sources, such as other vehicles equipped with ultrasound systems.
 - Heavy rain or snow, hail or dense exhaust gases.
 - If the number plate is not properly secured to the surface of the bumper.
 - Gradient changes.
- In order to guarantee good operation, keep the sensors clean, free of snow and ice, and do not cover them with stickers or other objects.
- If you use high-pressure or vapour equipment for cleaning, do not apply it directly, unless you do so very briefly, and always keep a distance of more than 10 cm away.
- Fitting certain accessories to the front of the vehicle, such as a plate holder with advertising, may interfere with the operation of the Park Assist.
- We recommend that you practice parking in an area without traffic.

- The volume and tone of the signals and indications can be changed.
- Please observe information on towing a trailer.

Note

In vehicles without an infotainment system, these parameters can be modified in a SEAT Official Service or in a specialised workshop.

Operating Park Assist Plus**Switching on and off manually**

- Press button **PWA** in the infotainment system [**☰** > Assistants > Parking assist > Parking aid].

Automatic activation

- Select reverse gear.
- **OR:** if you drive forward at a speed of less than 15 km/h (9 mph) and you encounter an obstacle, it is detected when it is optically approx. less than 95 cm. away, or acoustically approx. 50 cm. away. If the automatic connection is activated, a reduced display is shown.
- **OR:** if the vehicle moves back a certain distance [between approx. 10 and 20 cm approx depending on whether or not an obstacle is detected].

When the **Plus Parking Aid** connects automatically, a diagram of the vehicle and the segments will appear on screen. This function will be available unless the user has deactivated it.

It only operates every time the speed drops below 15 km/h (9 mph) for the first time.

Automatic activation of park assist can be switched on and off in the infotainment system:

- Switch the ignition on.
- In the infotainment system select **☰** > **Assistants** > **Parking** > **Parking aid**.
- Check the **Automatic activation** box.

If activated automatically, an audible sound warning will only be given when obstacles in front are at a distance of less than 50 cm. approx.


If it is switched off using the **PWA** button in the infotainment system, one of the following actions must be taken for it to reactivate automatically:

- Switch off the ignition and switch it on again.
- **EITHER:** drive forward at over approx. 15 km/h (9 mph).
- **OR:** activate or deactivate the parking lock button **P**.
- **OR:** switch the automatic activation on and off in the Infotainment system.

Automatic disconnection

- Drive forward at 15 km/h (9 mph) or faster.
- **OR:** press the parking lock button **P**.

Temporary sound suppression

- Press the  function button on the infotainment screen.
- **OR:** activate the electronic parking brake.

Change from reduced view to full view

- Engage the reverse gear if your vehicle is equipped with a reversing camera.
- Press the car icon on the reduced view
- **OR:** if the vehicle moves back a certain distance (between approx. 10 and 20 cm approx depending on whether or not an obstacle is detected).

Switch to the reverse assist image (Rear View Camera “RVC”)

- Select reverse gear.
- **OR:** press the RVC button on the Infotainment System screen ¹⁾.

A short confirmation signal will be heard and the button symbol will light up when the system is switched on.

NOTICE

Park assist plus only connects automatically when driving very slowly. If driving style is not adapted to the circumstances, an accident and serious injury or damage may be caused.

¹⁾ The RVC button will only be displayed when reverse gear is engaged.

Visual indication segments

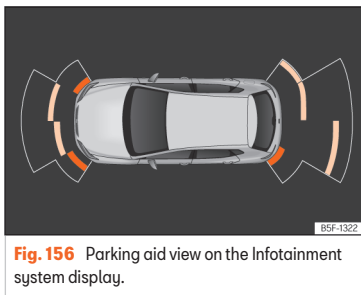




Fig. 156 Parking aid view on the Infotainment system display.

The optical indication of the segments works as follows:

- **Grey segments:** the obstacle is more than approx. 30 cm away from the path or in the direction opposite to travel. They are also displayed when the electronic parking brake is activated.
- **Yellow segments:** the obstacles lie on the vehicle's path and are at a distance of less than approx. 30 cm away.
- **Red segments:** obstacles are less than approx. 30 cm away.

A guiding track will indicate the anticipated forward or backward trajectory, depending on the gear that is engaged.

If an obstacle is located in the vehicle's way, the corresponding audible warning will sound.


When the penultimate segment is displayed, the vehicle has reached the collision zone. In the collision zone, the obstacles are represented in red (including those out of the path). Stop the vehicle!   in *Description on page 214*

Rear parking aid

Description

The rear park assist is an optical and audible assistant that warns of obstacles located behind the vehicle.

There are sensors integrated in the rear bumper. When they detect an obstacle, you are alerted by audible and visible warnings on the infotainment system.

Make particularly sure that the sensors are not covered by adhesives, residues, dirt and the like, as this could affect the system's operation. Cleaning instructions  **page 366**.

The approximate measurement range of the rear sensors is:

- Side area: 0.60 m
- Central area: 1.60 m

As you approach the obstacle, the frequency of the audible signals will increase. The signal will sound continuously at around 0.30 m: Stop the vehicle! » » ⚠ on page 214.

If the separation is maintained, the warning volume is reduced after about 2.5 seconds.


Parking Aid connection

- Select reverse gear.

Parking Aid disconnection

- Drive forward at 15 km/h (9 mph) or faster.
- **EITHER:** use the selector lever to select **N** or **D**, or press the parking lock button **P**.

Parking assist settings

The indications and audible signals are set in the Infotainment system: function button  > **Assistants** > **Parking** > **P** > **Settings**.

- **Rear volume:** Volume in the rear area.
- **Reduce volume:** When the parking aid is switched on, the volume of the audio source will be reduced, depending on the selected option.

Error messages

If an error or fault message appears on the instrument panel in Parking assist, there is a fault.

If the fault doesn't disappear before disconnecting the ignition, it will not be indicated next time the parking aid is connected.

We recommend taking the vehicle to a specialised workshop to have the fault repaired.

Towing device

In vehicles equipped with a towing bracket device from the factory, when the trailer is connected, the parking aid will not be activated when reverse gear is engaged.

⚠ WARNING

Observe the safety warnings » » ⚠ in *Description* on page 214.

Parking aid system (Park Assist)

Introduction

The assisted parking system is an additional function of ParkPilot » » page 213 and helps the driver find a suitable parking space from among the following types:

- park driving in reverse in suitable perpendicular and parallel spaces,
- park driving forwards in suitable perpendicular spaces,
- exit a parking space driving forwards from a parallel space,

- park in a suitable space driving forward on angle partially entering into the selected parking space. The system will centre the vehicle in the parking space,
- finish reverse parking into a space in which you have attempted to park manually by partially entering with the rear of the vehicle.

In vehicles with a Park Assist system and factory infotainment system, the front, rear and side areas are represented, and the position of obstacles is shown relative to the vehicle.

The assisted parking system is subject to certain limitations inherent to the system and its use requires special attention by the driver » » ⚠.

⚠ WARNING

The technology used in the park assist system involves a series of limitations inherent in the actual system and in the use of ultrasonic sensors. The use of Park Assist should never tempt you to take any risk that may compromise safety. The system is not a replacement for driver awareness.

- Any accidental movement of the vehicle could result in serious injury.
- Adapt your speed and driving style at all times to suit visibility, weather, road and traffic conditions.

- Certain surfaces of objects and garments do not reflect the ultrasound sensors' signals. The system cannot detect, at least correctly, these objects or people wearing such clothes.
- Ultrasound sensor signals may be affected by external sound sources. In certain circumstances this may prevent them from detecting people or objects.
- The ultrasound sensors may have blind spots in which obstacles and people are not detected.
- Monitor the area around the vehicle at all times, since the ultrasound sensors do not detect small children, animals or certain objects in all situations.

WARNING

- Quick turns of the steering wheel when parking or exiting a parking space with Park Assist can cause serious injury.
- Do not hold the steering wheel during manoeuvres to park or exit a parking space until the system requests it. Doing so disables the system during the manoeuvre, resulting in the parking being cancelled.

NOTICE

- In certain circumstances, the ultrasonic sensors do not detect objects such as trailer tongues, bars, fences, posts or thin trees, or an open (or opening) rear lid, which could damage the vehicle.
- Retrofitting of certain accessories to the vehicle, such as a bicycle rack, may interfere with the operation of the Park Assist system and cause damage.
- The Park Assist system uses as a reference parked vehicles, curbs and other objects. Make sure that the tyres and wheels are not damaged while parking. If necessary, opportunistically interrupt the parking manoeuvre to avoid damaging the vehicle.
- The ultrasound sensors on the bumper may be damaged or shifted in the event of a collision, for example, when entering or exiting a parking space.
- If you use high-pressure or vapour equipment to clean the ultrasound sensors, do not apply it directly unless very briefly and always from a distance of more than 10 cm.
- A registration plate or plate holder on the front with larger than the space for the registration plate, or a registration plate that is curved or warped can cause:
 - False detections.
 - The sensors to lose visibility.
 - Cancellation of the parking manoeuvre or defective parking.

- If one of the ultrasonic sensors is damaged, the area corresponding to that group of sensors (front or rear) is deactivated and cannot be activated until the fault is corrected. However, you can still use the sensors of the other bumper as per usual. If there is a fault in the system, consult a specialist workshop. SEAT recommends visiting a SEAT dealership for this.

Note

- In order to guarantee good system operation, keep the ultrasound sensors of the bumper clean, free of snow or ice, and do not cover them with adhesives or other objects.
- Certain sources of noise, such as rough asphalt or paving stones and the noise of other vehicles can induce the Park Assist system or ParkPilot to give erroneous warnings. The presence of metal objects can also affect the manoeuvre.
- In order to become familiar with the system and its functions, SEAT recommends that you practice operating the Park Assist system in an area where there is not too much traffic or in a car park.

Description of the parking assist system

The components of the Park Assist system are the ultrasonic sensors located in the front and rear bumpers, the **P** button to switch the system on and off and the messages on the instrument panel display.

Prerequisites for parking

- The traction control (TCS) must be switched on >>> page 175.
- Speed when passing next to the parking space: do not exceed approx. **50 km/h (31 mph)**.
- Keep a distance between **0.5 and 2.0 metres** when driving past the parking space.
- Space length (parallel parking): **vehicle length + 0.8 metres**.
- Space width (parking bay): **vehicle width + 0.8 metres**.
- Do not exceed approximately **7 km/h (4 mph)** when parking. The vehicle will perform an automatic braking only once if this speed is exceeded. If you exceed the speed more than once, the Park Assist system switches off.

Requirements for leaving the parking space (only for parallel parking)

- The traction control (TCS) must be switched on >>> page 175.
- Space length: **length of the vehicle + 0.5 metres**.
- Do not exceed approximately **7 km/h (4 mph)** when exiting the parking space.

Prematurely stopping or automatically interrupting the manoeuvres for parking or exiting a parking space

Park Assist interrupts the manoeuvres for parking or exiting a parking space in any of the following cases:

- Press button **P** in the infotainment system, **> Assistants > Parking > Park assist system**.
- When exceeding a speed of approximately 7 km/h (4 mph) more than once.
- The driver takes control of the steering wheel.
- The parking manoeuvre does not end within 6 minutes after activation of the automatic steering.
- There is a fault in the system (the system is temporarily unavailable).
- The TCS is disconnected.
- TCS or ESC intervene with regulation.
- The driver door is opened.

To restart the manoeuvre it is necessary that none of these things occur and that the **P** button on the infotainment system is pressed again.

Automatic braking intervention to avoid exceeding the speed limit


To avoid exceeding the allowed speed of approx. 7 km/h (4 mph) when entering or leaving a parking space, the brakes may activate automatically. After automatically activating the brakes, the manoeuvres to enter or exit a parking space may continue.

The brakes are only automatically activated once for each attempt to enter or exit a parking space. If the speed of approximately 7 km/h (4 mph) is exceeded again, the corresponding operation is halted.

Special characteristics

The Park Assist system is subject to certain limitations inherent to the system. For example, it is therefore not possible to use it to enter or exit a parking space on sharp bends or on very steep hills.

While entering or exiting a parking space, a brief signal sounds to prompt the driver to change between forward and reverse gears (depending on the case). In successive manoeuvres, the assistant tells the driver to change gears, at the latest, when the continuous audible signal is given (object present at a distance of ≤ 30 cm) by Park Pilot.

When the Park Assist system turns the steering wheel with the vehicle stationary, the instrument panel also displays the symbol . Keep the brake pedal depressed while the symbol remains on the dash panel display to turn the wheels with the vehicle stopped. This way, the system will require fewer manoeuvres to complete the parking action.

Trailer mode

The Park Assist system cannot be switched on if the factory-fitted towing bracket is electrically connected to a trailer.

After changing a wheel

If, after changing a wheel, the vehicle stops entering and exiting parking spaces correctly, the circumference of the new wheel may be different and the system may need to adapt to it. The adaptation is automatic and takes place during driving. Making turns slowly and in both directions [20 km/h [12 mph]] for a few minutes may contribute to this adaptation process.

Selecting a parking type



Fig. 157 On the instrument panel display: display of the assisted parking system with decreased visibility.

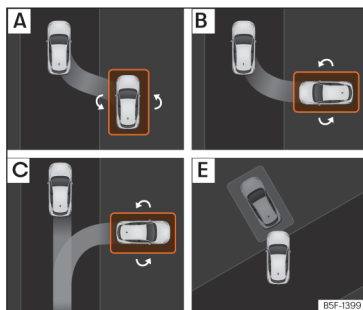



Fig. 158 On the infotainment system display: parking modes indication.

- A** Reverse parallel parking.
- B** Reverse angle parking.
- C** Forward angle parking.
- D** Reverse parallel parking without driving past first: "Help me".
- E** Forward parking in a parking bay without driving past first.
- F** Reverse parking in a parking bay without driving past first.

Selecting a parking type after passing in front of the space

After activating the Park Assist system and after detecting a parking space, the display on the instrument panel proposes a parking type. The Park Assist system selects the parking type automatically. The selected type is shown on the instrument panel display **>>> Fig. 158** and on the Infotainment System screen.

- The necessary conditions to park with Park Assist have to be met **>>> page 219**.
- Press the **P** button in the infotainment system,  **> Assistants**.
- When the system is switched on, the symbol on the infotainment system display is highlighted **P**. Additionally, the selected parking type is shown on the instrument panel display. You can change the type of parking on the infotainment system display.

Park assist has the following 6 parking types:

- If there are more spaces available, another space can be selected by clicking on it on the infotainment system display.
- Follow the instructions displayed on the instrument panel while paying attention to traffic and drive the vehicle past the parking space.
- When the system is switched on, the symbol on the infotainment system display is highlighted **P**. Additionally, the selected parking mode is shown on the instrument panel display without reduced display.
- Let go of the steering wheel.

Reverse parallel parking without driving past first (type **D**)

With this type of parking **D**, press button **P** so that the system completes the parking that has already been started. The system will only switch on if sufficient progress has been made with the manoeuvre (the side sensor must be able to detect the reference vehicle). If it is impossible to successfully complete the manoeuvre that has been started, the system itself will drive out of the parking space before starting parking in a similar way to type **A**.

Parking in a parking bay without driving past first

Special case of forward or reverse parking into a parking bay **E** without driving past first:

- The necessary conditions to park with Park Assist have to be met >>> **page 219**.
- Move forward towards the parking space while paying attention to traffic and stop the vehicle with the front part partially inside the parking space.
- Press the **P** button once in the infotainment system, **☰ > Assistants**.

Parking with the parking assist system

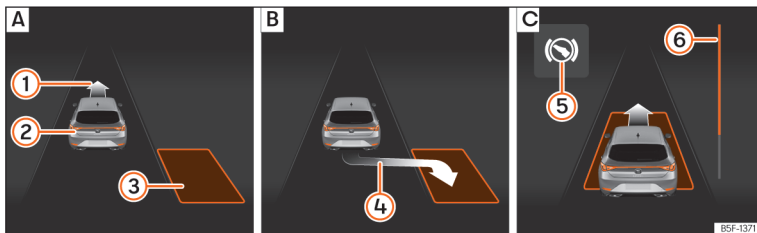


Fig. 159 On the instrument cluster display: angle parking. **A**: Finding a parking space **B**: Parking position. **C**: Manoeuvring.

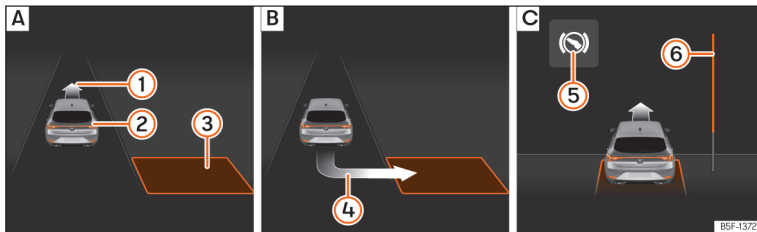


Fig. 160 On the instrument cluster display: angle parking. **A**: Finding a parking space **B**: Parking position. **C**: Manoeuvring.

- 1 Message to move forwards
- 2 Your vehicle
- 3 Parking space detected
- 4 Message to park
- 5 Message to press the brake pedal
- 6 Progress bar

The prerequisites have to be met to park with the parking assist system »» page 219 and the parking mode has to be selected »» page 220.

Parking

- Look at the instrument cluster screen to see if the space has been detected as “appropriate” and if the correct position for parking has been reached »» Fig. 159 **B** or »» Fig. 160 **B**. The space is considered “appropriate” if the instrument cluster display shows the parking indication **4**.

- Stop the vehicle and, after a brief pause, engage reverse gear, or press the button **P** in the infotainment system, **☰** > **Assistants** > **Parking** > **Park assist system**.

- Let go of the steering wheel.
- Please note the following message:

Intervention in active steering.
Watch your surroundings!

While keeping watch around you, carefully start accelerating up to no more than 7 km/h (4 mph). During the parking manoeuvre, the system **only** takes charge of the steering. **You, as the driver, have to accelerate, engage the clutch if necessary, change gears and brake.**

- Reverse until the continuous ParkPilot signal sounds; **OR:** reverse until the indication to move forward appears on the instrument panel display >>> Fig. 159 [C] or >>> Fig. 160 [C]; **OR:** reverse until the **Park Assist finished** message appears on the instrument cluster display. The progress bar [6] indicates the distance to cover.
- Press the brake pedal until the parking assist system completes the steering wheel turns; **OR:** until the symbol [S] goes out on the instrument panel screen.
- Select first gear.
- Move forward until the continuous ParkPilot signal sounds; **OR:** move forward until the reverse indication appears on the instrument panel display. The Park Assist system steers the vehicle forward and back until it centres it in the space >>> Fig. 159 [C] or >>> Fig. 160 [C].
- For best results, wait at the end of each manoeuvre until the Park Assist system has finished turning the steering wheel. The parking manoeuvre ends when a corresponding message is displayed on the instrument panel and, in some cases, an acoustic signal sounds.

Progress bars

The progress bar >>> Fig. 159 [6] and >>> Fig. 160 [6] on the instrument cluster display shows the relative distance to be covered as a symbol. The greater the distance, the fuller the progress bar. When driving forward, the content of the progress bar decreases upwards, and when reversing, it decreases downwards.

Note

If the manoeuvre is terminated prematurely during parking, the result may not be the best.

Leaving a parking space with the parking assist system (only for parallel parking)

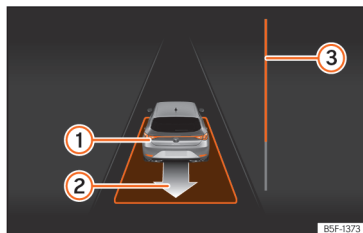


Fig. 161 On the instrument panel display: driving off from perpendicular parking.

- 1 Your vehicle in reverse gear
- 2 Message giving the proposed manoeuvre to exit the parking space
- 3 Progress bar to indicate the distance left to cover

Leaving a parking space (parallel parking)

The necessary conditions to exit a parking space with Park Assist have to be met >>> page 219.

- Press the **P** in the infotainment system: > **Assistants**. When the system is switched on, the symbol **P** on the infotainment system display is highlighted.
- Turn on the corresponding turn signal towards the road you will enter when exiting the parking space.
- Engage the reverse gear, or press the button **P** in the infotainment system.
- Let go of the steering wheel. Please note the following message:

Automatic steering enabled Pay attention to your surroundings.

While keeping watch around you, carefully start accelerating up to no more than 7 km/h (4 mph). When exiting the parking space, the system **only** takes charge of the steering. **You, as the driver, have to accelerate, engage the clutch if necessary, change gears and brake.**

- Reverse until the continuous ParkPilot signal sounds; **OR:** reverse until the instrument panel display shows the forward indication. The progress bar **»» Fig. 161 ③** indicates the distance to cover.
- Press the brake pedal until the parking assist system completes the steering wheel turns; **OR:** press the brake pedal until the symbol **(S)** goes out on the instrument panel screen.
- Move forward until the continuous ParkPilot signal sounds; **OR:** move forward until the reverse indication appears on the instrument panel display. The Park Assist system steers the vehicle forward and back until it can exit the space.
- The vehicle can exit the space when a corresponding message is displayed on the instrument panel and, in some cases, an acoustic signal sounds. Take charge of the steering with the turning angle set by the Park Assist system.
- Paying attention to the traffic, exit the parking space.

Reverse Assist (Rear View Camera)

Introduction

A camera on the rear bumper aids the driver when reverse parking or manoeuvring **»» page 181**.

The camera image is viewed together with orientation lines projected on the Infotainment system screen. Part of the bumper can be seen at the bottom, which can be used by the driver as a reference point.

Reverse assist modes

Depending on the equipment, the following modes are available:

- **Angle parking:** reverse parking perpendicular to the road.
- **Trailer towing assist function:** assistance with hitching a trailer.
- **Cross traffic:** monitors cross traffic.

Requirements

To park with reverse assist, the following requirements must be met:

- Do not exceed a speed of approx. **15 km/h (9 mph)**.
- Parking space width: **vehicle width + 0.15 m** (without counting the mirrors).

To display a real image, the following requirements must be met:

- The luggage compartment rear door is closed.
- The surroundings are on a flat surface.
- The vehicle should not be loaded very heavily at the rear.

WARNING

- The reverse assist does not make it possible to precisely calculate the distance from obstacles and nor can it overcome the system's own limits, hence its negligent use may cause serious accidents and injuries if used without due care. The driver should be aware of his/her surroundings at all times to ensure safe driving.
- The camera lens expands and distorts the field of view and displays the objects on the screen in a way that is different from reality. Distance perception is also distorted.
- Due to the screen resolution or light conditions, some items may be blurry or not displayed at all. Take care with thin posts, fences, railings or trees that might not be seen on the screen and could damage the vehicle.
- The reverse assist has blind spots where it cannot see people or objects. Monitor the vehicle's surrounding area at all times.
- The system is not a replacement for driver awareness. Supervise the parking manoeuvre and the vehicle's surrounding area at all times.
- Do not be distracted from the traffic by looking at the screen.
- The images are only two-dimensional. Protruding objects or holes in the road, for example, are more difficult to detect or may not be seen at all.


- Vehicle load modifies the representation of the guide lines. The width represented by the lines decreases with vehicle load. Pay special attention to the surroundings when the inside of the vehicle of the luggage compartment are loaded.
- In the following situations, objects or other vehicles appear to be further away or closer than they actually are. Pay special attention:
 - If moving from a flat surface to a slope and vice-versa.
 - If the vehicle is heavily loaded.
 - When the vehicle approaches objects that are not on the ground surface or that protrude from it. These objects may be outside the camera angle when reversing.

Note

- It is important to take great care and pay special attention if the driver is not familiar with the system.
- The reverse assist reference lines disappear when the rear lid is open.

Connecting and disconnecting

Connect the reverse assist

- With the ignition switched on, select reverse gear.
- **OR:** in the infotainment system select  > Assistants > Park assist.

Disconnect the reverse assist

- Drive forward at a speed of at least 15 km/h (9 mph).


Shown on the display

The system's functions and representations may vary depending on the equipment.

The assistant's image view changes when the factory-fitted tow hitch is electronically connected to a trailer >>> page 294.


Reverse assist functions and symbols


When the reverse assist is connected, you can make adjustments using the function buttons. Some adjustments are equipment-dependent.

 Exit the current display


 Switch to angle parking >>> page 226

 Switch to the trailer hitching assistance function

 Switch to cross traffic

 Adjust the display: brightness, contrast and colour.

 Switch to park assist >>> page 213

 Display/hide the parking aid view

Guide lines

Green horizontal lines: extension of the vehicle.

Yellow lines: vehicle path depending on the steering angle.

Assistance function for hitching a trailer

On vehicles with a factory-fitted towing device, this function can be used to move the vehicle close to a tow bar.

Auxiliary lines are shown in the infotainment system.

Green lines: distance to the trailer hitch. The distance between the lines is approx. 0.30 m

Yellow line: pre-calculated direction of the trailer hitch depending on how the steering wheel is turned.

Cross traffic

This view helps to monitor traffic behind the vehicle and can be used, for example, when exiting garages or narrow exits.

Angle parking

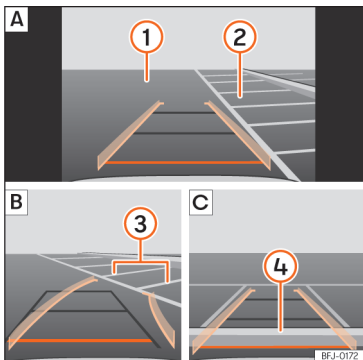


Fig. 162 Display on the infotainment system screen: parking with the reverse assistant.

Key to the >>> **Fig. 162:**

- A** Finding a parking space
- B** Go to the selected parking space
- C** Centre the vehicle inside the parking space
- 1** Road
- 2** Parking space
- 3** Lateral boundary of the parking space
- 4** Rear boundary of the parking space

Parking

- In the infotainment system select > **Assistants** > **Parking aid** before passing in front of the selected parking space.
- With reverse assist connected and in working order, press the function button .
- Stop the vehicle in front of the parking space >>> **Fig. 162 2 A**.
- Reverse while turning the steering wheel so that the yellow lines enter the parking space. The green and yellow lines must match the side boundary lines **3 B**.
- Stop the vehicle when the red line has reached the rear boundary **4 C**.

Troubleshooting

The system behaves differently than expected

There can be several causes:

- The camera is dirty >>> **page 366**. In addition to dirt and snow, camera visibility can be reduced by detergent residue or any type of coating.
- The system requirements must be met >>> **page 224**.
- The camera is covered with water.
- The factory-fitted towing bracket must not be electrically connected to a trailer >>> **page 294**.

- The vehicle has some type of damage in the camera area, e.g. due to a parking impact.
- The field of view of the camera is blocked by an accessory, e.g. a bicycle carrier system.
- Changes have been made to the paint in the camera area, or structural modifications have been made to a component such as the running gear.

Camera with no visibility, fault message, the system disconnects

- Clean the camera or remove possible adhesives or accessories from it >>> **page 366**.
- Check for visible damage.

Possible solution

- Temporarily disconnect the system.
- Check if one of the causes indicated above has occurred.
- Once the source of the problem has been eliminated, the system may be reconnected.
- If the system still behaves unpredictably, have it checked by a specialised workshop.

Rear Cross Traffic Alert¹⁾

How it works



Fig. 163 Diagram of the parking assistant: detected area around the vehicle that is driving off.

Park Assist uses the radar sensors on the rear bumper »» page 179 to monitor traffic crossing behind the vehicle as it reverses out of a parking bay, or as it is being manoeuvred, for example in very low visibility conditions.

When the system detects a relevant vehicle on the road that is approaching the rear of the vehicle »» Fig. 163, an acoustic alarm may sound if the relevance so requires it.

In addition to the acoustic alarm, the driver is also informed by means of a visual signal on infotainment system display. This signal is displayed in the form of a red strip at the back

of the image of the vehicle on the infotainment system screen. This strip displays the side of the vehicle towards which traffic is approaching in transverse direction¹⁾.

Automatic braking to reduce damages

»» page 211.

Connecting and disconnecting

The rear cross traffic alert can be activated and deactivated by accessing the **Assistants** menu of the infotainment system. It can also be found in the Park Assist **Settings** menu.

Additionally it can be switched on and off by accessing the **Assistants** menu on the instrument cluster.

When the vehicle is restarted, the last adjustment in the system will remain active.

Trailer mode

The rear cross traffic alert will be automatically deactivated and it will be impossible to activate them if the tow hitch is electrically connected to a trailer or other similar object. As soon as the driver starts driving, a message appears on the instrument cluster screen indicating that the assistant is deactivated.

Once the trailer is uncoupled from the vehicle, the assistant will return to its initial state prior to the moment when the trailer was electrically connected.

If the tow hitch is not factory fitted, then the rear cross traffic alert will have to be deactivated manually when driving with a trailer.

⚠ WARNING

The smart technology incorporated into the rear cross traffic alert cannot overcome the limits imposed by the laws of physics; it only works within the limits of the system. The parking assistant function should not tempt you into taking any risks. The system is not a replacement for driver awareness.

- The system should never be used in limited visibility conditions or complicated traffic, e.g., in high-traffic areas or when crossing multiple lanes.
- Be sure to always be aware of the vehicle's surroundings, since the system often fails to detect things such as bicycles or pedestrians.
- The rear cross traffic alert itself will not brake the vehicle to a complete stop.

¹⁾ It is only displayed if the vehicle is equipped with a parking system.

Exit Warning

How it works

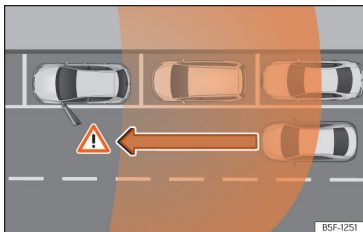


Fig. 164 Graphic example.

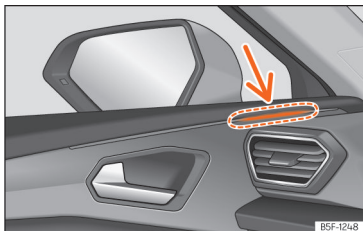


Fig. 165 Door: warning lamp

The door opening warning (Exit Warning) warns occupants of a possible collision when opening the door when the vehicle is stationary.

The system monitors, within the limits of the system itself, the rear and side environment of the vehicle using the rear sensors »» page 179. It detects moving objects that approach from behind, such as cars »» Fig. 164.

If a critical situation is detected when the door is opened, an alert is given by an acoustic signal on the door speaker of the corresponding side »» Fig. 165. The side assist control lamp on the side of the corresponding door will also flash. If the door has already been opened and another road user has been detected in a critical situation, the control lamp of the lane departure warning on the corresponding side will light up permanently.

The brightness of the door opening warning indication cannot be adjusted.

When you want to access the vehicle for the first time, with the doors closed and locked, the function will be available 3 minutes after the first opening of any of the doors. The function will continue to be available as long as the vehicle has the ignition connected and is not moving.

After switching off the ignition, the function will remain available for approximately 3 minutes. After that time, the control lamps will light up indicating the deactivation of the function.

Connecting and disconnecting

The door opening assistant can be switched on and off by accessing the **Assistants** menu in the infotainment system. It can also be found in the Park Assist **Settings** menu.

When the vehicle is restarted, the last adjustment in the system will remain active.

Trailer mode

The door opening assistant will be automatically deactivated and it will be impossible to activate it if the tow hitch is electrically connected to a trailer or other similar object.

Once the trailer is uncoupled from the vehicle, the assistant will return to its initial state prior to the moment when the trailer was electrically connected.

If the tow hitch is not factory fitted, then the door opening assistant will have to be deactivated manually when driving with a trailer.

WARNING

- **Always pay close attention to the traffic and the surroundings of the vehicle. The door opening warning (Exit Warning) cannot replace the necessary attention to be paid by the vehicle's occupants. Responsibility for opening the doors and exiting the vehicle always lies with its occupants.**

- The door opening warning (Exit Warning) operates continuously as long as the vehicle ignition is on. Otherwise, the system is deactivated and the lamps light up briefly.
- It is possible that the traffic situation is not interpreted correctly and you cannot be aware of all the objects that are approaching, such as pedestrians. Always visually monitor the traffic and the area surrounding the vehicle.

WARNING

The door opening warning (Exit Warning) is subject to system limits and cannot warn of an imminent collision in all cases:

- If your vehicle is too deep in the parking space and the adjacent vehicles hide it.
- In certain circumstances, objects or people who approach, e.g. on a bicycle or scooter, are not detected.
- The system does not react to stopped objects.

Practical equipment

Storage compartment

Introduction

Use the storage compartments only for small or light items.

⚠ WARNING

Objects inside the vehicle that are not secured could be thrown across the cabin in the event of sudden braking or manoeuvring. This may cause severe injuries as well as loss of control of the vehicle.

- Do not carry animals or sharp, hard or heavy items in open storage compartments of the vehicle, on the dashboard or on the cover behind the rear seats, or inside pieces of clothing or bags inside the vehicle.
- Keep the storage compartments closed at all times while the vehicle is in motion.
- Do not hang garments weighing more than 2.5 kg (approx. 5.5 lb) on the vehicle's coat hooks. Never leave heavy, hard or sharp objects in the pockets of these pieces of clothing.

⚠ WARNING

If you leave lighters inside the vehicle, they might be damaged or lit inadvertently. This could lead to severe burns and damage to the vehicle.

- Before moving a seat, make sure there are no lighters in the moving part area of the vehicle.
- Before closing a storage compartment, make sure there are no lighters in the closing area.
- Never leave a lighter inside a storage compartment or any other surface of the vehicle as it could ignite due to the high temperatures on such surfaces, particularly during the summer.

ⓘ NOTICE

- Do not store heat- or cold-sensitive objects, food or medicines in the cabin. Heat and cold could damage them or render them useless.
- Objects made from transparent materials left inside the vehicle, such as glasses, magnifying glasses or transparent suction pads stuck to the windows can concentrate sunlight and damage the vehicle.

Glove compartment

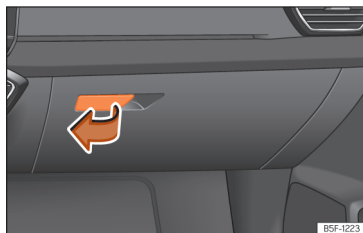


Fig. 166 On the passenger side: glove compartment.

Opening and closing the glove compartment

Opening: Pull the handle »» Fig. 166 and open the glove compartment.

Closing: Press the glove compartment upwards.

⚠ WARNING

If the glove compartment is left open, the risk of causing severe injuries in the event of an accident, sudden braking or manoeuvring increases.

- Always keep the glove compartment closed while the vehicle is in motion.

Drink holder



Fig. 167 In the rear central armrest: drink holder.

The storage compartments of the driver and passenger doors contain a bottle holder.

Front drink holders

There are two cup holders in the centre console.

Drinks holder in the rear central armrest

Use: Lower the central armrest.

When the drink holder is no longer in use, lift the armrest again.

⚠ WARNING

Incorrect use of the bottle holders may cause injuries.

- Never put hot drinks in the drink holders. In the event of sudden braking or an accident while driving, hot beverages in the bottle holders might spill and cause burns.
- Ensure that no bottles or other objects are dropped in the driver footwell while driving, as they could get under the pedals and obstruct their working.
- Never place glasses, food or other heavy objects drink holders. These heavy objects may be thrown across the cabin in the event of an accident and cause serious injuries.

⚠ WARNING

Closed bottles may explode inside the vehicle due to cold or heat.

- Never leave closed bottles in the vehicle if the temperature inside is very high or very low.

ⓘ NOTICE

Do not leave open cans in the drink holders when the vehicle is in motion. If the drink is spilled (e.g. due to sudden braking) it may damage the vehicle and its electrical system.

ⓘ Note

The inside elements of the drink holders can be extracted for cleaning.

Storage compartment under front seats



Fig. 168 Storage compartment under the right front passenger seat.

Opening: Press the tab on the drawer handle and take the drawer out.

Closing: Push the drawer under the seat until it engages.

WARNING

If the drawer is left open, it could prevent use of the pedals. This may cause serious accidents and injuries.

- Always keep the drawer closed while the vehicle is in motion. Otherwise, the drawer and any objects in it could fall into the driver's footwell and obstruct the pedals.

NOTICE

The drawer can contain 1.5 kg at most.

Other object holders

You will find more object holders, compartments and supports in other parts of the vehicle:

- In the centre console.
- In the upper part of the glove compartment. The load should not exceed 1.2 kg.
- Other storage compartments are found in the rear seat, to the left and the right of the seats.
- In the backrests of the front seats, storage pockets.

There are hangers on the struts of the doors and the rear.

WARNING

Hanging clothes may decrease the driver's visibility, which may cause serious accidents and injuries.

- Always hang clothes from hangers in such a way that the driver's visibility is not affected.
- Only hang light pieces of clothing from the hangers of the vehicle. Never leave heavy, hard or sharp objects in the pockets of these pieces of clothing.
- Do not use clothes hangers to hang up the clothing, as this could interfere with the function of the head-protection airbags.

NOTICE

Do not place overly large objects in the pockets on the front seat backrests (e.g. bottles) or objects with sharp edges. Risk of damage to the pockets and the upholstery.

Power sockets

Introduction

Electrical equipment can be plugged in to the vehicle's sockets.

The devices must be in a perfect state of repair. Do not use defective devices.

The 12 volt power socket will only work with the ignition on.

WARNING

Improper use of the sockets or electrical devices could lead to a fire and cause serious injuries.

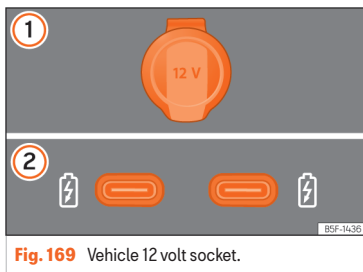
- Please ensure that children are never left unsupervised inside the vehicle. The sockets and the devices connected to them can be used when the ignition is switched on.
- If electrical devices overheat, switch them off immediately and disconnect them from the mains.

NOTICE

- To avoid damaging the electrical system, never connect electrical devices that supply power, such as solar panels or battery chargers, to 12-volt sockets to charge the 12-volt battery.
- Only use electrical devices that comply with the applicable electromagnetic compatibility directives.
- To prevent voltage fluctuations from causing damage, unplug any connected electrical devices before switching the ignition on and off.
- Never connect electrical devices that consume more than the specified power to a 12 volt socket. Exceeding the maximum power consumption could damage the vehicle's electrical system.
- Observe the instruction manuals of electrical devices!

Note

- The use of electrical appliances with the engine switched off will cause the 12-volt battery to discharge.
- Uninsulated devices can interfere with the radio, infotainment system and the vehicle's electronic system.

Vehicle power sockets**Fig. 169** Vehicle 12 volt socket.**>>> Fig. 169**

- ① 12-volt sockets inside the front armrest.
- ② 12-volt USB sockets at the rear of the console, between the front seats.

Make sure that the maximum power of the sockets is not exceeded. The power consumption of the devices is shown on the type plate of the devices.

The continuous output of all of the vehicle's 12-volt sockets is 120 watts in total.

When connecting two or more electrical devices at the same time, make sure that their total consumption never exceeds 190 watts.

USB power sockets

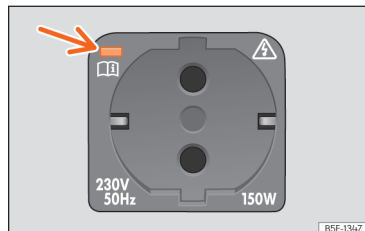
Depending on the equipment and the country, the vehicle may also have USB connections **exclusively for charging or as a power socket** >>> **Fig. 169 ②**.

These USB ports are located at the rear of the console, between the front seats. These connectors can work at a maximum power of up to 10,5 W per port.

NOTICE

If the 12-volt socket is used at full power for longer than the specified time, the fuse may blow.

- **Never use the 12 volt socket at full power for more than 10 minutes.**
- **In the case of full power, use a single 12-volt socket.**

230 volt power socket**Fig. 170** In the luggage compartment: 230 volt power socket.

With the engine running, the power socket activates automatically as soon as a connector is plugged in. If there is enough power available, the socket can still be used while the engine is off >>> **△**.

Maximum power consumption is 150 watts (300 watts - maximum 2 minutes).

Connect an electrical device: Open the cover and insert the plug into the power socket as far as possible to unlock the built-in child lock. The socket only supplies power once the child lock is unlocked.

LED on the power socket >>> Fig. 170 (arrow)

Steady green light:

- The childproof lock is unlocked. The socket is ready to operate.

Flashing red light:

- There is an anomaly, e.g. disconnection due to a current surge or overheating.

Disconnection due to overheating

When the temperature exceeds a certain value, the 230 volt socket inverter is automatically disconnected. The disconnection prevents overheating when the power consumption of the connected devices is excessive or the ambient temperature is very high. The 230-volt power supply can be used once again after a cooling time. First unplug the connector of the connected device and then plug it back in again. This prevents the electrical device from being switched on again if this is not wanted.

WARNING

The electrical system is under high voltage!

- Do not spill liquids onto the socket.
- Do not plug adapters or extension cords into the 230 volt power socket. Otherwise, the integrated child lock will be unlocked and the power socket will operate.
- Do not insert conductive objects (a knitting needle, for example) into the 230 volt power socket.

NOTICE

230 volt power socket:

- Do not leave devices or connectors that are too heavy (e.g. a transformer) hanging directly from the power socket.
- Do not connect neon lamps.
- Only connect devices to the socket if the device and socket voltage match.
- The built-in overload disconnect function prevents any electrical devices that require a high start-up current from turning on. In this case, unplug the electrical device's power supply and re-try the connection after about 10 seconds.

Note

Some appliances may not work properly when connected to the 230 volt sockets due to a lack of power (watts).

Data transmissions

Over-the-air update

Introduction

Over-the-air updates allow you to always keep your vehicle up to date, for example for optimising functions and for malware protection.¹⁾

How can you find out when an over-the-air update is available?

The available updates are displayed in the information system.

If several updates are available for the vehicle at the same time, one over-the-air update must first be successfully completed before the next one can be performed.

Note

It is in your own interest to complete updates as soon as possible. If the controller repeatedly rejects the over-the-air update, it will be necessary to visit a qualified workshop. SEAT recommends using a SEAT dealer.

WARNING

In very rare cases, a control unit may not function properly after an over-the-air update. Malfunctioning of a control unit and the vehicle can lead to serious accidents and fatal injuries.

- Reduce speed in a controlled manner if the vehicle operates or reacts differently than usual while driving.
- Contact a specialised workshop. SEAT recommends using a SEAT dealer.

WARNING

If the instrument cluster does not work after an over-the-air update, you will not be able to see instrument cluster displays, warning lights, symbols or text messages. Driving with an instrument cluster that does not work can lead to serious accidents and fatal injuries.

- Do not use the vehicle. Please contact the SEAT customer care service.

NOTICE

If special modifications have been made to vehicles outside the scope of SEAT's responsibility (for example, for emergency service vehicles or taxis), there is a risk that special functions (e.g. the taximeter) may no longer work properly after an over-the-air update.

- Consult with your SEAT dealer before performing an over-the-air update.

Note

- Measures to improve performance or efficiency (e.g. engine tuning) that have not been incorporated by SEAT may be deleted after an over-the-air update.
- Depending on the equipment, release notes may appear once before or after an over-the-air update. These release notes describe changes to the vehicle status. For release notes and more information on over-the-air updates, please visit the website: www.seat.com
- The over-the-air update will not update apps installed in the vehicle.

¹⁾ Not available on all markets.

Prerequisites for an over-the-air update

The following prerequisites must be met in order to be able to download an update via satellite and to install the update software.

- The over-the-air update function is available in your country.
- You have subscribed to a valid SEAT Connect contract.
- You have assigned the vehicle to your active user account.
- A primary user is available. You may need to register as a primary user.
- The vehicle is located in an area with sufficient mobile reception.
- Your current privacy configuration allows you to transmit and receive data and information
»» page 242.
- The vehicle's 12-volt battery is properly charged.

Download and install an over-the-air update

Download costs

Over-the-air updates are downloaded via the factory control unit with eSIM card, and are free of charge. SEAT covers the cost of the connection.

Download timing

Downloading takes place automatically without warning and may also happen while driving. When the download is complete, a message will appear to inform you that an over-the-air update is available.

Note

The duration of the download process depends on the quality of the network, the file size and the type of update. The download process may be interrupted. It will resume when the ignition is switched on again.

Software installation pre-requisites

- The vehicle is parked safely in accordance with legal requirements and local regulations
»» page 208.
- Previous over-the-air updates have been installed.

Installing the software from an over-the-air update

Choose a time for the over-the-air update when neither you nor others are unlikely to be driving the vehicle.

WARNING

The control units will be switched off and will not work while the software installation is in progress. Driving while the control units are switched off or faulty can lead to accidents and fatal injuries.

- Install the software in a way that does not interfere with other road users.
- Do not use the vehicle during a software installation procedure.

1. Deactivate the vehicle's drive system and apply the electronic parking brake.
2. Close the bonnet, boot, all windows and all doors.
3. Confirm the software installation in the Infotainment system.
4. Ensure that all occupants of the vehicle get out and that there are no animals left inside.
5. Collect all vehicle keys and get out.
6. Lock the vehicle.

Functional restrictions during software installation

The control units, central computer, functions and displays will not be available during the software installation. Do not use the vehicle or the Infotainment system during installation.

- The system prevents the activation of the vehicle's drive system.
- The high-voltage battery is not charged.
- The AUX-IN diagnostic socket is switched off.
- The anti-theft alarm is switched off.
- The "Safe" security system is switched off.

After installing the software

After the software installation and before activating the vehicle's drive system, read the message on the Infotainment system or in the Instrument cluster about the complete installation of the software. It can take up to 1 minute for the vehicle to display the status of the over-the-air update.

- The vehicle's drive system can be activated once the software has been successfully installed.
- If the software installation is not successful:
»» page 237, *Troubleshooting*.

Troubleshooting

The installation of an over-the-air update has failed.

- If an update is not installed correctly, an error message will appear in the infotainment system or in the instrument cluster. Observe the corresponding messages and warnings.

Note

The control units will stop working or will not work properly in the event of a critical installation error. The functions and screens will not be available until the error is amended. Do not use the vehicle. In this case, please contact SEAT customer care.

Can I interrupt the installation of an over-the-air update?

No, it is not possible.

What happens if the installation of an over-the-air update is interrupted?

If the installation is interrupted, for example due to damage to the vehicle's electrical system, the control units may not be updated and may not work due to incomplete installation of the update.

SEAT CONNECT

Introduction

With SEAT CONNECT Gen3 you can connect your vehicle to the Internet. This allows you to extend the scope of various services. A description of the available services can be found on the Internet at:

<https://www.seat.com/owners/connectivity/seat-connect-service>

To use it, SEAT CONNECT must first be activated online by entering into a SEAT CONNECT contract with SEAT, S.A. and is subject to a temporary use limitation depending on the country.

Both the SEAT CONNECT service portfolios offered by SEAT and individual services can be modified, cancelled, deactivated, reactivated, renamed and extended, even without prior notification.

The execution and availability of the SEAT CONNECT services and service portfolios may vary depending on the country, as well as the vehicle, its equipment and connectivity.

SEAT CONNECT's voice recognition or search technology does not recognise or offer results for all words.

There are SEAT CONNECT services for which registration is mandatory and others for which it is not mandatory.

Description of services

Before running SEAT CONNECT services, read and take into account the description of the corresponding services. Descriptions are updated on a non-periodical basis.

- Always use the most up-to-date version of the corresponding service description.

⚠ WARNING

In areas with insufficient mobile phone and GPS coverage, emergency calls and phone calls will not be connected and data cannot be transmitted.

- Change location if possible.

📌 NOTICE

The vehicle may be damaged by factors outside the control of SEAT, S.A. These damaged can include:

- Misuse of mobile terminals
- Data loss during transmission.
- Unsuitable or defective third party applications.
- Malicious software on data storage devices, computers, tablets or mobile phones.

Services portfolio

The initial service assignment shown here represents the maximum possible volume. The maximum possible volume is only available on a few vehicle models. During the useful life of the vehicle, you can change the assignment shown here.

After activating the service management in the infotainment system, you can check whether services are available to the vehicle and what services they are >>> **page 241**.

In some countries and in the event of a contract renewal, the services offered may be combined differently than indicated here. They may also vary depending on the year of production of the vehicle. The services mentioned correspond to **SEAT CONNECT Gen3** (third generation).

SEAT CONNECT services and functions that do not require activation

The following services also work without the activation of SEAT CONNECT:

- Public emergency call service.
- Privacy mode.
- Legal.

SEAT CONNECT services

The SEAT CONNECT services are:

- Public emergency call
- Roadside assistance call
- Customer support
- Service appointment planning
- Online system update
- Customisation
- Activating SEAT CONNECT
- Private mode (deactivation of services)
- Delete user / Reset factory settings
- Remote independent heating
- Remote opening
- Horn and turn signals

- Vehicle status incl. doors and lights
- Driving data
- Vehicle status report
- Anti-theft alarm warning
- Zone warning
- Speed warning
- Online map update
- Search for points of interest
- Petrol stations
- Online traffic information
- Parking lots
- Online infotainment system update
- Online route calculation
- Information on risks
- Dictation
- Natural voice control for destinations and addresses
- Online radio
- Online media
- Online route import
- Online destination import
- Remote auxiliary ventilation
- Parking position
- Privacy mode
- Legal

SEAT CONNECT services for hybrid vehicles

Available only in electric and hybrid vehicles.

The included services are all the SEAT CONNECT services in the previous section plus:

- Remote air conditioning
- Electrical power manager
- Departure times

SEAT CONNECT individual options

- In-Car Applications. These applications can be purchased and installed directly in the infotainment system through the In-Car store.
- Full Link.
- Data package. Pay per use data rates for the use of online functions, for example, 2 GB per month.

Note

- **The public emergency call service is available regardless of whether the infotainment system is logged in.**
- **Customisation and purchase of In-Car applications require logging into infotainment system, but the activation of the vehicle in a SEAT CONNECT account is not necessary.**

Activation of SEAT CONNECT and S-PIN

The following steps are necessary for the activation of SEAT CONNECT (including registration):

- Create a user account through the infotainment system in the User Management menu.
- Place the SEAT CONNECT order and activate it.
- Add the vehicle to your user account.
- Prove ownership.
- Prove your identity. It is only necessary if you are to run SEAT CONNECT services relevant to security.
- To activate it, proceed as follows:

10" **Users > Settings > Become primary user.**

8.25" **MENU > Manage users > Become primary user.**

Follow the rest of the indications and the information shown in the infotainment system. During activation, you may be asked to create an S-PIN.

Update option

10" Infotainment	yes
8.25" Infotainment	yes
SEAT CONNECT portal	yes
SEAT CONNECT application	yes

S-PIN

The S-PIN is a sequence of several digits, which can be selected when completed the SEAT CONNECT registration.

When creating the S-PIN, avoid easy-to-guess number sequences and known dates of birth. You can change the S-PIN in the SEAT CONNECT user account in "Account settings".

The S-PIN is necessary, for example, to protect your user profile or to run a SEAT CONNECT service relevant to the security of your vehicle. You must manage this S-PIN with absolute confidentiality.

If you reveal the S-PIN to third parties, for security reasons you must change it immediately.

Ownership and identity accreditation

Become primary user

To become a main user and thus prove ownership of the vehicle, you need both of the vehicle's physical keys. Ownership accreditation takes place in the vehicle during registration or, if you already have a SEAT CONNECT user account, you must log in through the infotainment system and then go to **User management**.

- Switch on the ignition and the infotainment system.
- In the infotainment system, register in SEAT CONNECT.

Or: open the menu **Users > Settings > Become primary user** and follow the instructions.

- Press the unlock button on the first vehicle key.
- Press the unlock button on the second vehicle key.

Once the infotainment system has processed the orders by radiofrequency, the accreditation of the ownership will have been completed. You can control the current status in the SEAT CONNECT portal.

How is ownership accredited?

10" Infotainment	2-Key method
8.25" Infotainment	2-Key method
SEAT CONNECT portal	No, it is not possible
SEAT CONNECT application	No, it is not possible

Identity accreditation (SEAT Ident)

Identity accreditation must be done before you can use SEAT CONNECT services that are relevant to security, such as the **Remote Opening** service. Proof of identity is provided at a SEAT dealership.

You can find more information about SEAT Ident on the SEAT CONNECT portal at <https://my.seat>.

Legal provisions

During the use of SEAT CONNECT services, information is transferred and processed online through the vehicle. Such data can also provide (at least indirectly) information about the driver in question, for example, driving behaviour and location. As a contracting party in the SEAT CONNECT contract with SEAT, S.A., you must ensure that when your vehicle is used by other drivers (for example, family or friends), data protection and personal rights are respected. Therefore, you must inform drivers in advance that the vehicle transfers and receives data online, and that you can access such data.

Not taking into account this obligation to inform, can infringe certain rights of the occupants.

Users can manage data sending and transfers through the privacy mode at any time.

Follow-up services: ask all occupants

The follow-up services need geographical and vehicle data to determine whether the vehicle is being used within defined speed ranges, where it has been parked or if it is being used in an established geographical area. This information is displayed on the SEAT CONNECT portal and in the SEAT CONNECT app.

Therefore, before moving off, ask all the vehicle occupants if they agree with the activated services. If they do not, deactivate the service in question (if possible) or do not allow the occupants to use the vehicle.

GPS tracking: marking

If the vehicle has a factory-fitted control unit that transmits its current geographical position and speed, the vehicle usually has this GPS marking, e.g. on the ceiling console. The absence of the marking on the vehicle does not guarantee that the control unit does not transmit the vehicle's current geographical position and speed.

Personal information

SEAT protects your personal data and only uses them, as long as the law allows it or you have given your consent on the occasion of a use. You will find detailed information on data processing in relation to SEAT CONNECT services in the Privacy Policy, which you can access in its corresponding current version on the SEAT website.

Permanent transfer of the vehicle

If another person has left you the vehicle for permanent use (for example, if you buy a used vehicle), SEAT CONNECT may already be activated and the previous user still has the possibility of accessing the data registered through SEAT CONNECT and control certain functions of your vehicle.

In the infotainment system you can check if your vehicle is assigned to a person as the main user. In this case, you can register yourself as the main user of the vehicle and thus automatically delete the previous main user. Alter-

natively, through the infotainment system you can directly and permanently delete the previous user as the main user, as well as put the vehicle in offline mode and thus limit both the communication of your vehicle with the SEAT, S.A. data server and the processing of personal and vehicle data.

Deactivating SEAT CONNECT services

The following functions are available to activate and deactivate the SEAT CONNECT services:

- Allow or prevent data transmissions through the infotainment system »» page 241, *Privacy mode*.
- Whenever possible: individual deactivation or activation »» page 241.

You can run the relevant services again after cancelling their deactivation.

Note

The services required by law and their data transmission cannot be disconnected or deactivated, for example, the emergency call system (eCall).

Faults

Even if the prerequisites for the use of SEAT CONNECT services are met, there may be factors beyond the control of SEAT, S.A. that interfere with the execution of such services or prevent them. These may be specifically:

- Maintenance, repair, deactivation, software update and technical expansion of telecommunication equipment, satellites, servers and data banks.
- Change of the mobile telephony standard for the transmission of mobile data by the telecommunications service provider, for example, from UMTS to EDGE or GPRS.
- Disconnection of an existing mobile phone standard by the telecommunications service provider.
- Interference, disturbance or interruption in the reception of the mobile phone and GPS signal due to aspects such as high-speed driving, solar storms, meteorological influences, topography, blocking equipment and the intensive use of mobile phones in the radio cells in question.
- When in areas with zero or insufficient mobile telephony or GPS signal. Also, for example, in tunnels, confined areas between very tall buildings, garages, underpasses, mountains and valleys.

- External information from third party supplies available with limitations, incomplete or incorrect, e.g. representations of maps.
- Countries and regions where SEAT CONNECT is not offered.

Service management

Open the settings in **Users** and go to **Privacy settings and services**.

- Check which SEAT CONNECT services are currently available in the vehicle.
- The number of SEAT CONNECT services that are enabled or disabled.
- Activate or deactivate SEAT CONNECT services.

Note

If you deactivate all SEAT CONNECT services, the vehicle can still transmit emergency call (eCall) data.

Privacy mode

Introduction

With the "Privacy" function, data transmissions between the vehicle and the Internet can be allowed or blocked.

The desired mode can be set in vehicle settings in the infotainment system.

Data transmission by external devices and their communication with the vehicle **cannot** be blocked using the "Privacy" function.

The services required by law and their data transmission cannot be disconnected or deactivated, for example, the emergency call system (eCall).

Note





Please note that all vehicle users can configure individual settings in the "Privacy" function. These settings may not match those desired by the vehicle owner.

Privacy and services settings

SEAT CONNECT services can be activated and deactivated individually. To do this, just check the box corresponding to the service you want to activate or deactivate. Use the privacy mode option if you want to deactivate all of the services at the same time.

Privacy mode

Allows you to deactivate or activate the services depending on the selected privacy level.

 Tracking	Share location. Main users and co-users can view position data on the SEAT CONNECT portal or app.
 Location	Use location. Position, vehicle, and user data are used for services.
 Personal	No location. Only the vehicle data and user data are used for services.
 Incognito	Maximum privacy. Your services are disabled. Only services required for legal reasons use data.

Setting options are not available in all markets or in all vehicle models.

Connectivity status indication

The following symbols indicate the respective data transmission status in the infotainment system.



Symbol white: full connectivity, all services active



Symbol grey: limited connectivity, some services may not be available.

no icon No connectivity, no services available.

WLAN access point

Introduction

The infotainment system can be used to share a WLAN¹⁾ connection with up to 8 devices **>>> page 243, Configuration for sharing a connection over WLAN.**

The infotainment system can also use the WLAN hotspot of an external device to provide Internet to the devices connected to the hotspot (WLAN client) **>>> page 243.**


Note

- There may be a charge for the required data transmission. Due to the high volume of data exchanged, SEAT recommends the use of a flat rate tariff for data transmission. Mobile phone operators can provide information on this.
- Exchanging data packages and purchasing them from third parties may generate additional costs, depending on your mobile phone rate, particularly if you are abroad (for example, roaming rates).

¹⁾ Not available on vehicles without SEAT CONNECT and without navigation

Configuration for sharing a connection over WLAN

Establishing the connection with the wireless network (WLAN)

- Press the **HOME > ** button.
- Activate the wireless network. To do this, press the function button **Wi-Fi > Infotainment system as hotspot**.
- Activate the wireless network (WLAN) on the device that is to be connected. If necessary, refer to the manufacturer's instruction manual.
- Activate the mobile device assignment in the infotainment system. To do this, press the function button **Use as hotspot** and check the checkbox.
- Enter and confirm the network key displayed on the device.

The following adjustments can also be made in the **Infotainment system as hotspot** menu:

- **Security level:** WPA2 encryption automatically generates a network key.
- **Network key:** Network key generated automatically. Press the function button to change the network key manually. The network key must have at least 8 characters and a maximum of 63.
- **SSID:** Name of the WLAN network [maximum 32 characters].

The WLAN (wireless) connection is established. To complete the connection, it may be necessary to enter other data into the device.

Depending on the version, it is only possible to connect in Hotspot mode to get SEAT CONNECT, and a maximum of 5 devices can be connected.

Repeat this process to connect other devices.

There is also the option of scanning the QR code by connecting the device directly to the infotainment system's Wi-Fi network without having to enter the password: select **Settings > Wi-Fi > Quick connection to infotainment system**.

An additional feature is that the infotainment system can provide data to any device over WPS (Hotspot mode) in the same menu as the QR code.

Wi-Fi Protected Setup (WPS)

✓ This depends on the equipment and the country in question.


Wi-Fi Protected Setup allows an encoded local wireless network to be created quickly and simply [**Settings > Wi-Fi > Wi-Fi > Quick WPS connection**].

- Establish the connection with the wireless network (WLAN).
 - Press the WPS button on the WLAN router until the warning light on the router starts flashing. If the WLAN router does not support WPS the network has to be set up manually.
 - **OR:** Press and hold the WLAN button on the WLAN router until the WLAN lamp on the router starts flashing.
 - Press the WPS button on the WLAN device. This establishes the WLAN (wireless) connection.
- Repeat this process to connect other devices.

Configure Internet access

The infotainment system can use the WLAN hotspot of an external device to establish an Internet connection.

Establishing the connection with the wireless network (WLAN)

- Activate and share a wireless hotspot with Internet on the external device. Refer to the manufacturer's instruction manual.
- Press the **HOME > ** button.
- Press the **Wi-Fi > Connect to Wi-Fi** menu and put a check in the checkbox.

- Press the **Search for Wi-Fi** button and select the device you want from the list.
- If necessary, enter the network key of the device in the infotainment system and confirm with **OK**.

Manual settings:

- To manually enter the network settings of an external (WLAN) device.

The WLAN (wireless) connection is established. To complete the connection, it may be necessary to enter other data into the device.



Note

Due to the large number of devices on the market, it is not possible to guarantee fault-free operation of all functions.

Full Link

Introduction

With Full Link it is possible to view and use the contents and functions that are shown on the mobile phone device on the infotainment screen.

To do this, the mobile phone device must be connected with the infotainment system through a USB interface.

Some technologies can also be used by Wireless Full Link through the Bluetooth® interface and a Wi-Fi connection.

The following technologies may be available:

- Apple CarPlay™
- Apple CarPlay™ Wireless
- Android Auto™
- Android Auto™ Wireless
- MirrorLink®

The availability of the technologies that Full Link includes depends on the country and the mobile phone device used.

You will find more information on the SEAT website (www.seat.com).

Access the Full Link main menu

Browsing the Full Link main menu depends on the infotainment system used.

- Press **Home > Full Link**

Configure Wireless Full Link

In order to use Wireless Full Link, you must first pair the mobile phone device with the infotainment system. To do this, proceed as follows:

Connect a mobile phone device for the first time.

- Unlock the mobile phone device.
- Enable Wi-Fi reception and Bluetooth® on the mobile phone device.
- Connect the mobile phone device to the infotainment system using a USB cable or via Bluetooth®.
- Access the **Full Link** main menu, if it is not displayed automatically.
- Select the mobile device and the technology you want.
- Confirm authorisation inquiries on the mobile phone device to grant the necessary authorisations to the infotainment system.
- Disconnect the USB connection and connect with the infotainment system again via Wi-Fi or Bluetooth®. Wireless Full Link is now configured.

The pairing has concluded. The connected mobile phone device can also use Wireless Full Link from now on without the USB connection.

If pop-up menus are rejected during the connection process, Wireless Full Link will not be available. In this case, SEAT recommends deleting the devices in both the telephone settings and the infotainment system, and restarting the connection process.

⚠ WARNING

The use of applications while driving can distract your attention from the traffic. Any distraction affecting the driver in any way can lead to an accident and cause injuries.

- Always drive as carefully and responsibly as possible.

⚠ WARNING

Any applications that are not suitable or execute incorrectly may cause damage to the vehicle, accidents and serious injuries.

- Protect the mobile phone device and its applications from inappropriate use.
- Never carry out modifications to the applications.
- Follow instructions in the instruction manual for the mobile phone device.

ⓘ NOTICE

SEAT cannot be held liable for any damage caused to the vehicle as a result of the use of applications that are of poor quality or are defective, the inadequate programming of the applications, the insufficient coverage of the network, the loss of data during transmission or the improper use of mobile phone devices.

ⓘ Note

- Wireless Full Link may not be compatible with all technologies.
- When crossing the border into countries with permitted radio frequencies different to those in your own country, running the Full Link Wireless function may be restricted or even unavailable due to legal regulations. This can also be indicated by a message in the infotainment system. Running Full Link via cable is not affected by this restriction and can continue to be used.

Applications (apps)

With SEAT Full Link, the display of the contents of SEAT applications and other providers installed on mobile phone devices can be transferred to the infotainment screen.

In the case of third-party applications, there may be compatibility problems.

Applications, their use and the necessary mobile phone connection may be pay per use.

The offer of applications can be varied and designed for a vehicle or a specific country. The content and volume of applications, as well as the companies that offer them, may vary. Some applications also depend on the availability of third-party services.

It cannot be guaranteed that all the applications offered will work on all mobile phone devices or with all their operating systems.

The applications offered by SEAT can be modified, cancelled, deactivated, reactivated and extended without prior notification.

To avoid distracting the driver while driving, only certified applications can be used.

Full Link symbols and settings

- i** To show more information.
- ⚙** To open the Full Link settings menu
- 🍏** To select Apple CarPlay technology.
- 🗺** To select Android Auto™ technology.
- 🔗** To select MirrorLink® technology.

Apple CarPlay™

In order to use Apple CarPlay™, the following requirements must be met:

- The iPhone™ **must** be compatible with Apple CarPlay™.
- Voice control [Siri™] **must** be active on the iPhone™.
- Apple CarPlay™ **must** be active without limitations in the iPhone™ settings.

- If this is not possible via Apple CarPlay™ Wireless, the iPhone™ **must** be connected to the infotainment system via a USB connection. Only USB connections with data transmission are suitable for the use of Apple CarPlay™.
- The USB cable used **must** be an original Apple™ cable.

Apple CarPlay™ Wireless: Bluetooth® and Wi-Fi must also be activated on the iPhone™.

Establish connection

When you first connect an iPhone™, follow the instructions on the infotainment system screen and on the iPhone™.

The requirements must be met to use Apple CarPlay™.

Launch Apple CarPlay™:

- Press **HOME > Full Link** to access the Full Link main menu.
- Press Apple CarPlay™ to establish a connection with the iPhone™.

Disconnecting

- In Apple CarPlay™ mode, press the **SEAT** icon to access the Full Link main menu.
- Press **X** to interrupt the active connection.

The representation of function buttons on the screen may vary.

Special characteristics

During an active Apple CarPlay™ connection, the following characteristics are applicable:

- Bluetooth® connections between the iPhone™ and the infotainment system are **not** possible.
- If there is an active Bluetooth® connection, it is automatically interrupted.
- The phone functions are only available through Apple CarPlay™. The functions described for the Infotainment system are not available.
- The connected iPhone™ **cannot** be used as a media device in the **Media** main menu.
- It is **not** possible to use the built-in navigation system and the Apple CarPlay™ navigation system at the same time. The last route started interrupts the one that was previously active.
- Depending on the infotainment system you use, on the instrument panel screen you can view data from the Telephone mode.
- Depending on the infotainment system you use, on the instrument panel screen you can view data from the Media mode.
- The instrument panel screen does not display any indication to turn.
- With the multifunction steering wheel you can accept or reject incoming calls, as well as end an ongoing telephone conversation.

Voice control

- Press **Ⓜ** briefly to start voice control using the infotainment system.
- Press this button for a long time to start voice control (Siri™) of the connected iPhone™.

Note

- **The availability of technologies depends on the country and may vary.**
- **You will find information about technical requirements, compatible iPhones, certified applications and their availability on the SEAT (www.seat.com) and Apple CarPlay™ websites, or at SEAT dealerships.**

Android Auto™

Requirements for Android Auto™

In order to use Android Auto™, the following requirements must be met:

- The mobile phone device, called smartphone from here on, **must** be compatible with Android Auto™.
- The smartphone **must** have an Android Auto™ application installed.
- If this is not possible via Android Auto Wireless, the smartphone must be connected via the USB connection with data transmission to the infotainment system.
- The USB cable used **must** be an original cable provided by the smartphone manufacturer.

Android Auto Wireless: Bluetooth® and WLAN (Wi-Fi) also have to be active on the smartphone.

Establish connection


When you first connect a smartphone, follow the instructions on the infotainment system screen and on the smartphone.

The requirements must be met to use Android Auto™.

Launch Android Auto™:

- Press **HOME > Full Link** to access the Full Link main menu.
- Press Android Auto™ to establish a connection with the smartphone.

Disconnecting

- In Android Auto™ mode, press the  **SEAT** icon to access the Full Link main menu.
- Press **X** to interrupt the active connection.

Special characteristics


During an active Android Auto™ connection, the following characteristics are applicable:

- An active Android Auto™ device can be connected at the same time via Bluetooth® (HFP profile) with the infotainment system.
- It is possible to use the phone's functions through Android Auto™. If the Android Auto™ device is connected at the same time via Blue-

tooth® with the infotainment system, the telephone function of the infotainment can also be used.

- An active Android Auto™ device **cannot** be used as a media device in the **Media** main menu.
- It is **not** possible to use the built-in navigation system and the Android Auto™ navigation system at the same time. The last route started interrupts the one that was previously active.
- Telephone and Media data can be displayed on the instrument cluster screen.
- With the multifunction steering wheel you can accept or reject incoming calls, as well as end an ongoing telephone conversation.

Voice control

- Press  briefly to start voice control using the infotainment system.
- Press and hold this button to start voice control (Google Assistant) on the connected smartphone.

Note

- **The availability of technologies depends on the country and may vary.**
- **You will find information about technical requirements, compatible mobile phone devices, certified applications and their availability on the SEAT (www.seat.com) and Android Auto™ websites, or at SEAT dealerships.**

MirrorLink®

Requirements for MirrorLink®

In order to use MirrorLink®, the following requirements must be met:

- The mobile device **must** be compatible with MirrorLink®.
- The mobile phone device **must** be connected to the infotainment system via a USB connection that is suitable for data transmission.
- The USB cable used **must** be an original cable provided by the mobile phone device manufacturer.
- Depending on the mobile phone device used, a Car-Mode application that is suitable for using MirrorLink® **must** be installed.

Establish connection

When you first connect a mobile phone device, follow the instructions on the infotainment system screen and on the mobile phone device.

The requirements must be met to use MirrorLink®.

Start MirrorLink®:

- Press **HOME > Full Link** to access the **Full Link** main menu.
- Press **MirrorLink** to connect to the mobile device.

Disconnecting

- In MirrorLink® mode, press **APP** to access the Full Link main menu.
- Press X to interrupt the active connection.

Special characteristics

During an active MirrorLink® connection, the following characteristics are applicable:

- An active MirrorLink® device can be connected to the infotainment system at the same time via Bluetooth®.
- If the MirrorLink® device is connected to the infotainment system via Bluetooth®, the telephone function of the infotainment system can be used.
- You **cannot** use an active MirrorLink® device as a media device in the **Media** main menu.
- On the instrument panel screen you can view data from the Telephone mode.
- The instrument panel screen does not display any indication to turn on the Media mode.
- With the multifunction steering wheel you can accept or reject incoming calls, as well as end an ongoing telephone conversation.

Function buttons

Function buttons and their function:

- **APP** Return the Full Link main menu. Here you can end the MirrorLink® connection, connect another mobile phone device or select another technology.

- **X** Press to close the open apps. Then press the apps to be closed or the **Close a11** function button to close all the open applications.
- **Phone** Press to display the mobile phone device screen on the infotainment system screen.
- **Settings** To open the MirrorLink® settings.

Note

You will find information about technical requirements, compatible mobile phone devices, certified applications and their availability on the SEAT (www.seat.com) and MirrorLink® websites, or at SEAT dealerships.

Wired and wireless connections

USB connection



Fig. 171 Centre console: USB input.



Fig. 172 Rear centre console: USB connectors with power socket function.

The USB port can be found in the storage compartment area of the front centre console

»» **Fig. 171.**

Depending on the equipment and the country, the vehicle may also have USB connections **exclusively for charging or as a power socket.**

These USB ports are located at the rear of the console, between the front seats »» **Fig. 172.**

Note

Before switching the ignition on or off, unplug the appliances from the USB ports to protect them from any damage caused by fluctuations in voltage.

Infotainment system

First steps

Introduction

Infotainment functions and settings depend on the country and equipment.

Before first use

Before the first use, bear in mind the following points, to take full advantage of the functions and settings offered:

- Observe the basic safety warnings »» page 250.
- Restore infotainment to factory settings.
- Search and store favourite radio stations on the preset buttons so you can tune them quickly.
- Use only suitable audio sources and data media.
- Pair a mobile phone to use phone management through the Infotainment system.
- Use current maps for navigation.
- Register in SEAT CONNECT to run the corresponding services.

Current documentation attached

For using infotainment and its components, take into account, together with this instruction manual, the following documentation:

- Supplements to your vehicle's on-board documentation.
- Instruction Manual of the mobile phone device or audio sources.
- Operating instructions for data media and external players.
- Manuals for the Infotainment accessories subsequently installed or used additionally.
- Description of services when running SEAT CONNECT services.

Safety instructions

Some function areas may include links to third-party websites. SEAT, S.A. is not the owner of the third-party websites accessible through the links, and assumes no liability for their content.

Some function areas may include outside information from third-party providers. SEAT, S.A. is not responsible for such information being correct, up-to-date or complete, or for ensuring it does not infringe the rights of third parties.

Radio stations and owners of data media and audio sources are responsible for the information they transmit.

Bear in mind that parking lots, tunnels, tall buildings, mountains or due to the operation of other electrical devices, such as chargers, can also interfere with the reception of the radio signal.

Foils or adhesives with metallic layers on the antenna and on the window panes can interfere with radio reception.

WARNING

The infotainment central computer is interconnected with the control units mounted on the vehicle. Therefore, there is a serious danger of accident and injury if the central computer is repaired or disassembled and reassembled incorrectly.

- **Never replace the central computer with another used, recycled or from another vehicle at the end of its useful life.**
- **The repair or disassembly and reassembly of the central computer should only be carried out at specialised workshops. SEAT recommends visiting a SEAT dealership for this.**

⚠ WARNING

Any distraction affecting the driver in any way can lead to an accident and cause injuries. Reading the information on the screen and managing the infotainment system can distract your attention from traffic and cause an accident.

- Always drive as carefully and responsibly as possible.

⚠ WARNING

Connecting, inserting or removing an audio source or data media while driving can distract your attention from the traffic and cause an accident.

⚠ WARNING

Select volume settings that allow you to easily hear signals from outside the vehicle at all times (e.g. emergency services sirens).

- Hearing may be impaired if using too high a volume setting, even if only for short periods of time.

⚠ WARNING

The following circumstances may result in an emergency call, phone call or data transmission not being made or being interrupted:

- When in areas with zero or insufficient mobile telephony or GPS signal. Also in tunnels, confined areas between very tall buildings, garages, underpasses, mountains and valleys.
- When in areas with sufficient mobile phone or GPS signal, the telephony network of the telecommunications provider has interference or is not available.
- When the vehicle components necessary to make emergency calls, phone calls and to transmit data are damaged, do not work or do not have sufficient electrical power.
- When the battery of the mobile phone device is discharged or its charge level is insufficient.

⚠ WARNING

In some countries and some telephone networks it is only possible to make an emergency call, if a mobile telephone device is connected to the telephone interface of the vehicle, inside it there is an "unlocked" SIM card with sufficient balance to make calls and with sufficient network signal coverage.

⚠ WARNING

Read and observe the operating instructions provided by the manufacturer in question when using mobile phone devices, data media, external devices, external audio and multimedia sources.

⚠ WARNING

When changing or connecting an audio or multimedia source may cause sudden changes in the volume.

- Lower the volume before connecting or switching to audio or multimedia sources.

⚠ WARNING

If mobile phone and radiocommunication devices are used without connection to an external antenna, the maximum electromagnetic radiation levels inside the vehicle might be surpassed, thus posing a risk to the health of the driver and passengers. This is also the case if the external antenna has not been correctly installed.

- Keep a distance of at least 20 centimetres between the antennas of the mobile phone device and an active medical device, such as a pacemaker, as mobile phones might alter the functioning of these devices.
- Do not carry a mobile phone switched on very close or directly on top of an active medical device, for instance in a chest pocket.

- Immediately turn off the mobile phone if you suspect it is causing interferences in an active medical device or any other medical device.

WARNING

Mobile phones, external devices and accessories that are loose or not properly secured could move around the passenger compartment during a sudden driving or braking manoeuvre or an accident and cause damage or injury.

- Set mobile phone devices, external devices and their accessories outside the airbag deployment areas or store them securely.
- Position the connection cables of the audio sources and external devices so that they do not interfere with the driver.

WARNING

The centre armrest may obstruct the driver's arm movements, which could cause an accident and severe injuries.

- Keep the storage compartments of the centre armrest closed at all times while the vehicle is in motion.

WARNING

If the light conditions are not good and the screen is damaged or dirty, the indications and information displayed on the screen may not be read or be read incorrectly.

- The indications and information displayed on the screen should never induce to take any risk that compromises safety. The screen is not a replacement for driver awareness.

WARNING

Radio stations can transmit disaster or hazard announcements. The following conditions prevent such notices from being received or issued:

- When in areas with zero or insufficient radio signal. Also in tunnels, confined areas between very tall buildings, garages, underpasses, mountains and valleys.
- When the frequency bands of the radio station have interference or are not available in areas with sufficient radio signal reception.
- When the speakers and the vehicle components necessary for radio reception are damaged, do not work or do not have sufficient electrical power.

WARNING

Switch off mobile phone devices in areas with a risk of explosion!

WARNING

The driving recommendations and traffic indications shown on the navigation system may differ from the current traffic situation.

- Traffic signs, signalling systems, traffic regulations and local circumstances prevail over driving recommendations and navigation system indications.
- Adapt your speed and driving style to suit visibility, weather, road and traffic conditions.
- Certain circumstances can significantly initially planned lengthen both the duration of the trip and the route to the destination, or even temporarily prevent navigation to it, for example, if a road is closed to traffic.

NOTICE

In areas where special regulations apply or the use of mobile phones is forbidden, the mobile device in question must be switched off at all times. The radiation produced by a mobile phone device when switched on may interfere with sensitive technical and medical equipment, possibly resulting in malfunction or damage to the equipment.

NOTICE

If the playback volume is excessive or distorted, the speakers may be damaged.

Overview and controls

Connect System

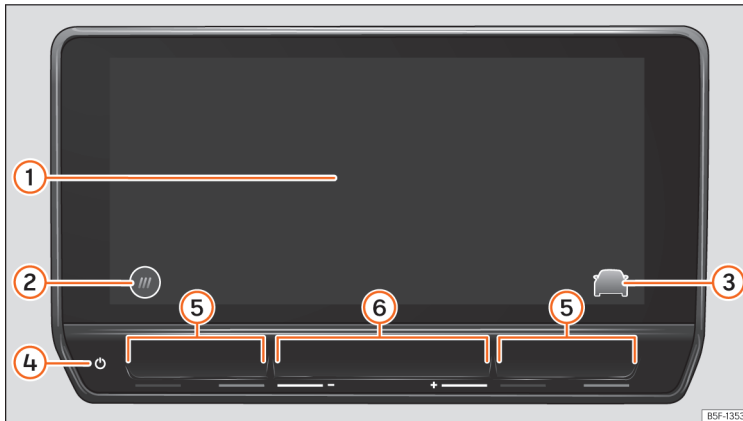


Fig. 173 Overview: control unit

- ① Touch screen. The infotainment functions can be used through the screen.
- ② HOME button.
 - ⊞: main menu with widget views.
 - ⊞: main menu in tile mode.
- ③ Direct access button to the assist systems and vehicle settings.
- ④ On/Off touchpad [to turn the infotainment system on/off].
- ⑤ Touch zones (to raise and lower the air conditioning temperature).
- ⑥ Touch zones (to raise and lower the volume).

Media System

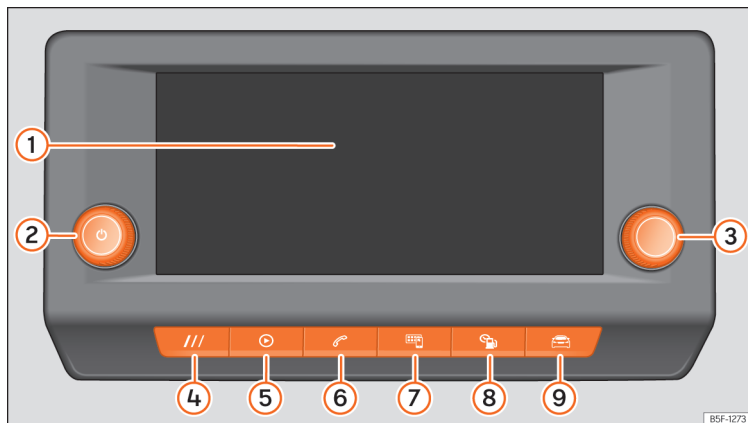


Fig. 174 Overview: control unit and indication in the 8.25-inch version

- ① Touch screen. The infotainment functions can be used through the screen.
- ② Rotary push button (to adjust the volume and to switch the infotainment on/off)
- ③ Rotary push button (to search and select)
- ④ HOME button (to open the start page)
- ⑤ Radio/Multimedia »» page 262
- ⑥ Telephone »» page 276
- ⑦ Full Link »» page 244
- ⑧ Vehicle information »» page 37
- ⑨ Vehicle settings »» page 38

General instructions for use

Operating indications

- The infotainment needs a few seconds for the complete start-up of the system and during that time it does not react to inputs. Only the image of the rear view camera system can be displayed during system start-up.
- The display of all indications and the execution of functions only takes place once the infotainment system has finished booting. The duration of the system booting depends on the number of infotainment functions and may take longer than normal in the event of very high or very low temperatures.
- When using the infotainment system and corresponding accessories, e.g., headphones, bear in mind country-specific regulations and legal provisions.
- Some functions of the infotainment system require an active SEAT CONNECT user account and an Internet connection for the vehicle. The data transmission must not be limited to perform the functions.
- To use the infotainment system, simply lightly press a button or touch the screen.
- For the correct operation of the infotainment system it is important that it is switched on and that, if necessary, the time and date of the vehicle are set correctly.
- If a function button is missing on the screen, it is not a device defect, but corresponds to the specific equipment of the country or version.
- Some infotainment functions can only be selected when the vehicle is at a standstill. In some countries the parking lock must also be enabled (button **P**) or the selector control must be in the neutral position **N**. This is not a malfunction, but is due to compliance with legislation.
- Restrictions on the use of devices using Bluetooth® technology may apply in some countries. For further information, contact the local authorities.
- If you disconnect the 12 volt battery, turn on the ignition before restarting the infotainment system.
- If the setup is changed, this may change the display on the screen and in some cases, the infotainment system may behave in a manner different to that described in this instruction manual.
- In some countries, the infotainment system automatically shuts off when the engine is switched off and the vehicle's 12-volt battery charge level is low.
- Ensure that any repairs or modifications that need to be carried out on the infotainment system are carried out by a specialised workshop. SEAT recommends visiting a SEAT dealership for this.
- Using a mobile phone device inside the vehicle may cause noise in the speakers.
- On vehicles with park assist, the audio source volume is automatically lowered when reverse gear is selected. The volume reduction can be adjusted.
- Information about the included software and the license conditions can be found in **Settings > Copyright**.
- When selling or lending the vehicle, make sure that all saved data, files and settings have been deleted and, if necessary, external audio sources and data media have been removed.

Note

You will find more information and tips for using the infotainment system in the **Help menu**.

HOME screen

In the control and display unit you can set up the views and representation on the home screen or use the factory setting templates.

If an icon is missing on the screen, it is not a device defect, but corresponds to the specific equipment of the country or version.


The following menus can be included as an icon on the home screen:

Main menus on the home screen





Navigation >>> page 269


 Radio >>> page 262, Media >>> page 266

 Telephone >>> page 276

 Full Link >>> page 244

 Settings >>> page 257

 Vehicle >>> page 38

 Data >>> page 37

 Air conditioning >>> page 132

 Sound

 Users

 Store

 Legal

 Help

Managing the infotainment system

Execute the functions and settings with the infotainment controls.

Depending on the equipment, the infotainment system has different controls:

- Touch screen.
- Touch zones outside the screen, for example, Volume [+ -].
- Function buttons, for example, **RADIO** or **MEDIA**.

Open the Quick Guide

More information and operating tips can be found in the Infotainment Quick Guide.

- Press **HOME** >  **Help**.

Connecting and disconnecting the infotainment system

The infotainment system turns on when the ignition is switched on, unless it has been manually turned off beforehand.

The infotainment system starts-up with the last set volume, provided that this does not exceed the preset maximum start-up volume.

The infotainment system automatically turns off when the driver's door is opened, provided the ignition has been switched off beforehand.

Moving objects and adjusting volume

Move objects on the screen to adapt settings, for example, with scrollable buttons or to move the areas of a menu.

Depending on the equipment, menus and displays can be customised.

Increasing and reducing images or map sizes

Tip: use your thumb and index finger.

- Press on the map with both fingers at the same time and leave them on the screen.
- To enlarge views, slowly separate one finger from the other. To reduce views, slowly bring one finger towards the other.

Note

If you turn on the infotainment system manually with the ignition off, it will automatically turn off after about 30 minutes.

Note

As with most state-of-the-art computer and electronic equipment, in certain cases the system may need to be rebooted to make sure that it operates correctly. To do this, if appropriate, press and hold the **On/Off** button of the infotainment system (>>> page 253) for approx. 15 seconds until the **SEAT** logo appears on the display.

Customising the infotainment system

Customise the menus and infotainment views to quickly access your favourite or most frequently used functions.

The main menu contains function buttons for accessing all of the Infotainment apps.

Configuring customised menus

In all views (except Main Menu, StandBy, Parking, Speller and Full Link), you will find shortcuts to customizable system functions in the lower part of the screen. Use the settings to delete or replace them, or change their order.

- Press and hold one of the icons (or press on the icon of an empty position) to display an additional window.
- Select one of the icons from the apps bar.
- Press X to delete an icon.
- Click on an icon in the additional window to replace the value.
- Hold your finger on one of the icons and drag it to the desired position.
- To close the edit mode, press X in the additional window.





Settings (system and sound)

The selection of possible settings varies depending on the country, the equipment in question and the equipment of the vehicle.

Modifying settings

The meaning of the following symbols are valid for all system and sound settings.

All changes are automatically applied when the menus are closed.

<input checked="" type="checkbox"/> / 	The setting is selected and activated or connected.
<input type="checkbox"/> / 	The setting is not selected, disabled or disconnected.
	To open a drop-down list.
+	To increase a setting value.
-	To reduce a setting value.
<	To go back step by step.
>	To go forward step by step.
	To change a setting value with the scrollable button without adjusting.


Sound settings

- Access the sound settings: **HOME > **.

In the sound settings there may be the following functions, information and setting options:

- Equaliser.
- Position.
- Settings.

System settings

- Access the system settings: **HOME > **.

In the system settings there may be the following functions, information and setting options:

- Screen.
- Time and date.
- Language.
- Additional keypad languages.
- Units.
- Voice control.
- Wi-Fi.
- Data connection.
- Manage mobile devices.
- Reset factory settings.
- System information.
- Copyright.
- Configuration wizard.

Adjust the volume of external audio sources

If you need to increase the playback volume for the external audio source, first lower the volume on the infotainment system.

If the sound from the connected audio source is **very low**, increase the **output volume** on the external audio source. If this is not enough, change the **input volume** to **medium** or **high**.

If the sound from the connected external audio source is **too loud or distorted**, lower the **output volume** on the external audio source. If this is not enough, change the **input volume** to **medium** or **low**.

Clean the screen

Remove persistent dirt carefully and without using aggressive cleaning products. To clean the screen we recommend that:

- The infotainment system is switched off.
- Use a clean, soft cloth dampened with water
- »» page 365.
- In case of persistent dirt: soften the dirt by moistening with a little water. Then carefully remove with a clean, soft cloth.

NOTICE

Cleaning the screen with inappropriate cleaning products or when dry, may damage it.

- **When cleaning, only press lightly.**
- **Do not use aggressive cleaning products or that contain solvents. Such products may damage the equipment and darken the screen.**

Trademarks, licenses and copyrights

Registered trademarks and licenses

Certain terms in this manual bear the symbol ® or ™. These symbols indicate that they are trademarks or registered trademarks. The ab-

sence of this symbol, however, does not necessarily mean that the term in question can be used freely.

Other product names are registered trademarks of the respective rights holders.

- Manufactured under license from Dolby Laboratories. Dolby and the double-D symbol are trademarks of Dolby Laboratories.
- Manufactured under license from Dolby Laboratories. Dolby, Pro Logic and the double-D symbol are trademarks of Dolby Laboratories.
- Android Auto™ is a trademark of Google Inc.
- Apple CarPlay™ is a trademark of Apple Inc.
- Bluetooth® is a registered trademark of Bluetooth® SIG, Inc.
- iPod®, iPad® and iPhone® are trademarks of Apple Inc.
- MirrorLink® and MirrorLink® Logo are certified trademarks of Car Connectivity Consortium LLC.
- Windows® is a registered trademark of Microsoft Corporation, Redmond, USA.
- MPEG-4 HE-AAC audio coding technology and patents are licensed by Fraunhofer IIS.
- This product is protected by certain Microsoft Corporation industrial and intellectual property rights. The use or commercialization of technol-

ogy of this type outside the configuration of this product, without a licence from Microsoft or an authorised Microsoft branch is prohibited.

Copyright

As a general rule, audio and video files stored on data media and audio sources are subject to intellectual property protection in accordance with the national and international provisions applicable in each case. Please bear in mind all legal provisions!

Technical data

Radio with integrated hardware (8.25")¹⁾

The factory-mounted radio in the vehicle with integrated hardware includes country-specific components and software for connectivity and for the execution of vehicle, comfort and infotainment functions.

The corresponding indications are displayed on the radio screen and partly on the instrument panel.

- Capacitive colour screen:
 - 8.25 inch version, TFT, WVGA: 1082 x 480 pixels.
- Touch operation via the device screen, rotary push-button, menu button and buttons on the multifunction steering wheel.

¹⁾ Equipment name: Media System.

Central computer with control and display unit¹⁾

The factory-mounted central computer in the vehicle includes country-specific components and software for connectivity and for the execution of vehicle, comfort and infotainment functions.

The corresponding indications are shown on the control and display unit screen and partly on the instrument panel.

- Capacitive colour screen
- Using the equipment with:
 - Touch zones Touch operation.
 - Buttons on the multifunction steering wheel.
 - Proximity sensors and gesture control.

HOME > ⚙ Settings > Display.

Vehicle and comfort functions

- Assistants system settings.
- Heating and air conditioning settings.
- Lights and visibility function settings.
- Vehicle comfort settings.
- Parking and manoeuvring settings.

Sound system (basic equipment):

The infotainment system that is supplied from the factory is equipped as follows:

- Speakers in different locations and with different power levels (watts).
- Internal amplifier depending on the system:
 - 4 speakers: 2 x 20 W
 - 7 speakers: 5 x 20 W

Setting options:

- Equaliser, depending on the system:
 - 4 speakers: treble, mid and bass and default settings.
 - 7 speakers: 5 frequency bands and default settings.
- Sound distribution, depending on the system:
 - 4 speakers: Balance (left / right)
 - 7 speakers: Balance + Fader (left / right / front / rear).
- Sound optimisation by zones (valid for the 7-speaker system):
 - Manual (Driver and All)
 - Automatic depending on the seats occupied.

Optional sound system

The infotainment system can be extended with an optional sound system as follows:

- 10 speakers in different locations and with different power levels (watts).
 - External amplifier (340 W Ethernet), which processes the audio signals sent by the central computer.
 - Excitation of speaker channels through class AB final stages.
 - Audio signal processing in digital internal signal processor (DSP).
 - Independent subwoofer in the luggage compartment.
- Setting options:
- User equaliser: 5 bands.
 - Preset equaliser settings.
 - Sound distribution: Balance (left / right) + Fader (front / rear).
 - Sound optimisation by zones:
 - Manual (Driver, Front and All)
 - Automatic depending on the seats occupied.
 - Subwoofer volume.
 - Surround settings.

Wi-Fi

- Wi-Fi conforming to IEEE 802.11 b/g/n.
- 2.4 GHz and 5 GHz transfer (depending on the country).

¹⁾ Equipment name: Connect System

- Apple Car Play™ and Android Auto™ over Wi-Fi
- Simultaneous connection of up to 8 Wi-Fi devices.
- **Media System:**
 - 5GHz access point for Full Link Wireless only
- **Connect System:**
 - Access point
 - Tethering
 - Pairing process simplified by WPS or QR code

Bluetooth® profiles

There can be a maximum of two mobile devices connected to the Bluetooth® hands-free and a third device connected to the Bluetooth® as a music player.

When a mobile phone is connected to the telephone management system, a data exchange takes place via one of the Bluetooth® profiles.


- **Hands-free telephone profile (HFP):** the HFP can be used to manage calls through the infotainment system.
- **Audio profile (A2DP):** This profile allows audio to be transmitted with stereo quality. It may require connecting other profiles for managing and controlling playback.
- **Phone book access profile (PBAP):** Allows phone book contents to be downloaded from the mobile telephone.

- **Messaging profile (MAP):** It allows short messages (SMS) and emails to be downloaded and synchronised.

Voice control

Introduction

Voice control works both online and offline, taking into account the aspects indicated in the section **"Languages available depending on the market"**. In online mode, commands are recorded more accurately, as more data is available.

Voice control understands questions and expressions without having to learn commands. Commands can be formulated freely and can be colloquial. Command proposals can be found in the  **Help > Voice control** menu.

Functions are reduced in offline mode.

Loud noises inside or outside the vehicle can cause malfunctions, as well as confusing phrases and answers.

Languages available depending on the market

- **Online and offline:** German, American English, British English, French, Italian, Spanish, Czech, Dutch, Polish, Portuguese, Swedish, Danish and Norwegian. These languages have

advanced functions such as Online Commands, air conditioning control, natural interaction, etc.

The other languages of the infotainment system **do not** offer air conditioning control or natural interaction.

Requirements

- **Online and offline:** voice control with the corresponding infotainment installed in the vehicle.
- **Online:** current SEAT CONNECT Plus contract active.

Note

- **Voice control only recognises commands in the language that is set in the infotainment system.**
- **Test the voice control with the vehicle stopped before starting to move to familiarise yourself with its operation.**
- **The online voice search will be faster and more reliable if the privacy setting "Use location" is selected and you consent to the use of location data in the app on your mobile device.**
- **Voice control can only control functions that are available as part of the vehicle's equipment.**

Wake word and commands

Voice control wake words

Voice control starts when the infotainment recognises the wake word.

If you have connected the voice control via the wake word, the connected infotainment replies with "What would you like to do?".

- **OR:** after the wake word, say the desired command, for example: "Hola Hola" and then "heating".

The system scans the words spoken in the vehicle after the wake word.

Connect and disconnect the wake word

- Press **HOME** > **Settings** > **Voice control** > **Activate / deactivate wake word.**

Wake word:

Hola Hola

Commands

To help the voice control recognise commands reliably:

- Pronounce clearly. Confusing commands are not recognised. Speak in a normal tone of voice. Speak a little louder if you are driving at high speed.
- Avoid outside noises. Open windows and doors can interfere with voice control.

- Avoid other secondary noises, such as conversations in the vehicle. Do not direct the air flow from the outlets towards the microphone or the interior lining of the roof.

- Do not make long pauses.



Voice control is active and recognises the words pronounced.

Open the command proposals

- Press **HOME** > **☰** >

Note

- When the activation word is disconnected, the infotainment system cannot be activated by means of the activation word. Voice control is still available via the button on the multifunction steering wheel.
- Availability depends on country and equipment.

Start and stop voice control

Depending on the equipment, you can start voice control in different ways.

Start voice control

- *Voice control activation:* say the word that activates voice control.
- *Multifunction steering wheel:* press the voice control button .

In some cases you can also start voice control of the connected mobile phone device, by pressing and holding the voice control button.

Manually ending voice control

Voice control can be cancelled with the **Cancel** command.

- *Multifunction steering wheel:* tap the voice control button twice in a row, or press and hold.

The voice control ends automatically, if you use infotainment functions, if the parking system is activated or by incoming calls.

Radio mode

Introduction



Fig. 175 Schematic diagram: Radio view.

In Radio mode you can tune in the available radio stations in different frequency bands and memorise your favourites on the preset buttons to access them quickly.

The types of reception and frequency bands available depend on the equipment and the country. In certain countries, frequency bands may stop broadcasting or not be available again.

Access the RADIO menu

- Press **HOME** > **▶** > **☰** >>> **Fig. 175**.

Access the settings

- Press **HOME** > **▶** > **⚙️**.

Online functions in Radio mode

Online functions in Radio mode are only available under the following conditions:

- SEAT CONNECT or SEAT CONNECT Plus equipment.
- You have an active SEAT CONNECT user account.
- The vehicle is assigned to your user account.
- You have a corresponding data package acquired from the In-Car store or have a data volume for your own mobile phone device via Wi-Fi access point.

Note

- For streaming services you need to have an account with the provider in question.
- Radio stations are responsible for the content of the information they transmit. Electrical equipment connected to the vehicle may also cause interference in radio signal reception and noise in the loudspeakers.
- Foil or metal-coated stickers attached to the windows may affect reception on vehicles with a window aerial.

Radio equipment and symbols

The functions, as well as the types of reception and frequency bands available depend on the equipment and the country.

- AM tuner.
- Dual FM receiver (diversity antenna).
- Summarised FM station list.
- Merger of DAB and FM stations into one list.
- Fusion of all stations stored in preset buttons into one list. Maximum 36 favourite stations.
- Station logos.
- DAB presentation (slideshow). Images that are emitted sequentially.
- Internet radio.

Universal symbols in Radio mode


AM To select the desired AM frequency band.

FM/DAB To select the desired FM/DAB frequency band.

Internet radio To select the type of Internet radio reception.

TP Next to the name of the station, monitoring of active traffic information stations (TP).

Symbols on the FM/DAB frequency band

 To display the frequency band for manual selection of the FM frequency. Only possible when the summary station list is disconnected.

 DAB not available.

 DAB stations support presentations (slideshow).

Symbols on the AM frequency band

 Manually updating the station list.


 To display the frequency band for manual selection of the AM frequency.


Menus in Internet radio mode


 Show station selection.


 Open text search.


 Show the last online radio stations heard.

 Show the 100 most played radio stations and podcasts.

 Show available online radio podcasts.

 Show online radio stations, grouped by country.

 Show online radio stations by the desired language.

 Show online radio stations whose programme belongs to the desired musical genre.

Selecting, tuning and saving a station

Select the frequency band

Before selecting a station you have to select a frequency band or a type of reception. Different stations are available depending on the frequency band selected or the type of reception.

The types of reception and frequency bands available depend on the equipment and the country.

- Select the frequency band or type of reception: AM, FM/DAB, FM (for devices that do not have DAB), Internet radio.

Search and select a station

You can select radio stations in different ways. The options vary depending on the frequency band and the type of reception.

Select via the frequency band (AM and FM)

1. Activate the frequency band.
2. Click on the cursor, scroll through the frequency band and release it when you reach the frequency band you want.

OR: press on a point on the frequency band. The cursor will automatically jump to the corresponding frequency.

The station of the set frequency is tuned.

Select from the station list (AM and FM/DAB)

The station list shows the stations that are currently tunable. In the AM frequency band, you may have to update the station list if you are no longer in the area where you last accessed the station list. In the FM/DAB frequency band, the station list is automatically updated.

1. Open the station list
2. Press the station you want.

The selected station is tuned. In the case of FM/DAB and if the station is available, the best quality reception is automatically selected.

Search and filter stations (Internet radio)

In Online Radio mode, stations can be filtered by categories and can be searched by text.

1. Open the station list.
2. Select the category by which the stations are to be filtered.

OR: press Q to start the text search. The input field is displayed.

3. Enter the name of the station you want. The list of the stations found is updated while entering the text.
4. Press the station you want.

The selected station is tuned.

Save stations on the preset keys

You can store up to 36 stations of different frequency bands and reception types as favourites using the preset buttons.

1. Tune the station you want.
2. Access the preset buttons.
3. Press the preset button and keep it pressed until the station is stored.

OR: press the station on the station list and keep it pressed. The preset buttons are displayed.

4. Press the preset button.

The station is stored in the selected preset button.

If a station was already stored in the preset button, it is overwritten with the new station.

Special functions in Radio mode**Traffic information (TP)**

The TP function monitors the announcements of a station with traffic information and automatically reproduces them in the Radio mode or in the multimedia playback that is active. To do this, you have to be able to tune into a station with traffic information.


Some stations without their own traffic information support the TP function by broadcasting traffic information from other stations (EON).

In the FM frequency band or in the Multimedia mode, a station with traffic information in the background is automatically tuned while it is possible to tune into a station with traffic information.

If no station with traffic information can be tuned in, the device automatically searches for stations with tunable traffic information.

Stations with traffic information are not available in all countries.

Activating and deactivating the TP function

- In Radio mode or Multimedia mode, press  > **Traffic programme (TP)**.

Presentations (SlideShow) in DAB

The slideshow function (SLS) is a feature of digital radio (DAB) stations, allowing a slideshow of images, e.g. the station's logo, to the user.

Activating and deactivating the SLS function

It is possible to deactivate the slideshow function on DAB radio stations:

- In the Radio Menu click on the area where the station information is located, either in the name or on the additional information (author or information text).

OR: tap **Radio Settings > Display DAB picture gallery and additional information** (activate/deactivate).

Online radio

Online radio is a type of reception for Internet radio stations and podcasts that are independent of AM, FM and DAB. Thanks to Internet transmission, reception is not limited to the region.

Online radio is only available through the Internet connection of the active infotainment system. The use of online radio can generate expenses due to the transmission of data from the Internet.

- In Online radio mode, press and set the audio quality to high or low to tune the online radio.



Station logos

In the case of some frequency bands, station logos may already be pre-installed in the infotainment system.

If in the FM/DAB frequency band settings the **automatic selection of station logos** is activated, station logos are automatically assigned to the stations.

In the Online radio mode, the infotainment system accesses the station logos of the online database and automatically assigns them to the stations.

Assign station logos manually

1. In FM/DAB mode, press **Station logos**.
2. Press on the  icon and then select the station to which a station logo is to be assigned.
3. Select the station logo. If desired, repeat the same process with other stations.
4. **OR:** via the menu  > **Station logos**.

Media Mode

Introduction

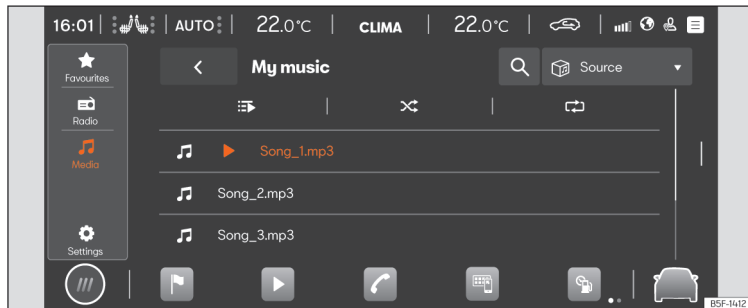


Fig. 176 Schematic diagram: Media view

In Media mode you can play multimedia files from data media and streaming services through the infotainment system.

Depending on the equipment, the following data media can be used:

- USB storage support (for example, a USB stick, a mobile phone connected via USB).
- Bluetooth® device (for example, a mobile phone or a tablet).

Depending on the equipment, the following types of multimedia files can be played:

- Audio files.
- Video files (depends on the system).

You can also use streaming services. The availability of streaming services depends on the equipment and the country.

To use streaming services you need to have your own user account in the streaming service in question.

Access the MEDIA menu

- Press **HOME** > ► > 🎵 >>> **Fig. 176**.

Access the settings

- Press **HOME** > ► > ⚙️.

Limitations and indications of data media

Data media may not work if they have been exposed to high temperatures or have been damaged. Please bear in mind the manufacturer's indications.

Quality differences between data media produced by different manufacturers can cause multimedia playback malfunctions.

Incorrect configuration on a data media may cause the data media to be unreadable.

Playlists only specify a playback order and refer to the storage location of the multimedia files within the folder structure. In a playlist there are no multimedia files saved. To play a

playlist, multimedia files have to be found in the storage places of the data media to which the playlist refers.

Note

SEAT assumes no liability for any deterioration or loss of files on data storage devices.

Equipment features and media symbols

Audio, multimedia and connectivity:

- Media playback and control via Bluetooth®.
- Audio playback in these formats: AAC, ALAC, AVI, FLAC, MP3, MP4, WMA.
- Video playback in these formats: MPEG-1 and MPEG-2 (.mpg, .mpeg), ISO MPEG4, Xvid (.avi), ISO MPEG4 H.264 (.mp4, .m4v, .mov), Windows Media Video 10 (.wmv, .asf).
- Playlists on any type of device.
- Multimedia streaming (online).
- Multimedia search.

Universal symbols in Media mode

- ▶ Start playback.
- || Pause playback.
- ◀ Change to the previous track.
- ▶ Change to the next track.
- ↺ Repeat the track that is playing.

- ↺ Repeat all titles.
- ✂ Activate the shuffle playback order.
- ★ Display a list of favourites.
- ⊕ Add a media file as favourite.
- ▼ Top right: select media source.
- ⚙ Access the settings.
- 🔍 Open the search.
- ◀ Return to the top folder of the media source.

Select and play a multimedia source

Select multimedia source

Before playing multimedia files you must first connect a multimedia source.

To use streaming services you must be connected to the Internet.

- Connect an external multimedia source.
- Select the connected media source to be used for playback.

Playing audio and video files

You can search and play multimedia files from an available multimedia source in different ways.

Search in the folder structure

Multimedia files can be catalogued by categories (for example, album, artist, title). In **My media** this category view is always displayed. The classic folder structure of individual USB data media is also found in **My media**.

1. Activate the folder structure.

The folder structure of the selected multimedia source is displayed. When **My media** is selected, the categories (music, videos, playlists) and connected multimedia sources are displayed first.

2. Search for the title you want in the folder structure.

OR: press **Q** to start a text search The input field is displayed.

3. Enter the name of the desired title. The list of the titles found is updated while entering the text.
4. Press the desired title.

If at the beginning of the playback your selection is in a folder of a multimedia source, the multimedia files that are in it are also added to the playback.

If a playlist is played, all available titles in the playlist are added to the playback.

5. Close your selection with **X**.

Select favourites

In favourites you can save titles, music genres, artists and albums individually for playback.

- Access favourites ★.
- Press the favourite you want.

Depending on your selection, all the titles belonging to the favourite are added to the playback.

Save favourites

Only multimedia files in **My media** of the infotainment system can be saved as favourites. You can save up to a maximum of 30 titles, albums, artists and music genres individually as favourites.

1. Start playback.
2. Access favourites.
3. Tap a favourite that is not assigned.

OR: press and hold on an existing favourite for approx. 3 seconds.

4. Select from the selection list: Title, Album, Artist, Genres, Playlist.


The selection is saved instead of the previously selected favourite. If the favourite was already assigned, the previously saved favourite is overwritten.

The selectable options in the selection list depend on the data attached to the multimedia file. If the music genre is not indicated in the music files, for example, you cannot save the music genre as favourite.

If a video file is playing, only that video can be saved as favourite.

Configure streaming services

Depending on the equipment you can use streaming services directly through the infotainment system. For this you need to have a premium user account of the streaming service in question and you have to log in with it in the infotainment system. You also need to be connected to the Internet.

1. Select  **Streaming** as the multimedia source.

A list of available streaming services is displayed.

2. Select the streaming service you want.
3. Follow the steps indicated by the infotainment system.

The streaming service is added to the list of multimedia sources as a new function button.

Playing entertainment content in the infotainment system

Depending on the infotainment system, videos can be played.

Video mode

When in video mode, a video can be played on the infotainment screen if this is stored on a data media, in **My media** or is sourced from a streaming service. In this case, the video sound is played through the vehicle's speakers.

The image is only displayed if the vehicle is stopped. When the vehicle is in motion, the infotainment screen turns off. The sound of the video can still be heard.

A stable Internet connection is required for playback from a streaming service. In this case, telephony costs may be generated.

Navigation

Introduction



Fig. 177 Schematic diagram: Navigation view.

A global satellite system determines the current position of the vehicle and the sensors mounted on the vehicle analyse the routes taken. All measured values and possible traffic events are compared with the available maps to allow optimal navigation to the destination.

Navigation announcements and graphic representations will guide you to your destination.

Navigation management is carried out on the screen.

Depending on the country, some functions of the infotainment system will not be available on the screen when travelling above a certain speed. It is not a malfunction, but is due to compliance with legislation.

Navigation announcements

Navigation announcements are acoustic indications for driving referred to the current route.

The type and frequency of navigation announcements depend on the driving situation, for example, starting the guide to the destination, driving on the motorway or on a roundabout and the settings.

If the exact destination cannot be reached because, for example, it is in a non-digitised area, indications relating to the address and the distance to the destination are displayed on the screen.

During dynamic route guidance, you will receive information about reported traffic congestion on the route. An additional navigation announcement is given if the route is recalculated due to traffic congestion.

While a navigation announcement is playing, its volume can be adjusted. The following navigation announcements provided will be played with the newly adjusted volume.

Limitations during navigation

If the infotainment system cannot receive data from GPS satellites, for example, in a tunnel or in an underground garage, navigation continues using the vehicle's sensors.

In areas that are not digitised or are only partially digitised on the infotainment memory, the infotainment system will still attempt to provide route guidance.

In the case of missing or incomplete navigation data, it may not be possible to determine the exact position of the vehicle. This may mean that navigation is not as precise as usual.

Roads and streets are subject to constant change (e.g. new roads, road works, roads closed to traffic, changes to street names and building numbers). If the navigation data is obsolete, this may lead to errors or inaccuracies during the route guidance.

Managing the navigation map

To allow an optimal view, you can also manage the navigation map with additional finger movements.

Moving the map

Tip: use your index finger

- Move the map with your finger.

Zoom in

Tip: use your index finger

- To increase the view in a certain position, double-click on the map.

Zoom out

Tip: use your index and middle fingers

- Press on the map with both fingers at the same time.

Change view

Tip: use your index finger

- Press twice on the map and keep your finger pressed on the screen.
- To zoom out the view of the map, move your finger upwards. To zoom in the view of the map, move your finger downwards.

Change view

Tip: use your thumb and index finger

- Press on the map with both fingers at the same time and keep them pressed.
- To zoom out the view of the map, move one finger towards the other. To zoom in the view of the map, move one finger away from the other.

Tilt the view

Tip: use your index and middle fingers

- Press on the map with both fingers at the same time and horizontal to each other, keep them pressed.
- To tilt the view of the map forward, move your fingers upwards. To tilt the view of the map backward, move your fingers downwards.

Rotate the map

Tip: use your thumb and index finger

- Press on the map with both fingers at the same time and keep them pressed.
- To rotate the map view, turn your fingers clockwise anticlockwise.

Saved data

The infotainment system saves certain data, for example, frequent routes and position data, to make the entry of the destination more agile and optimise the route guidance.

Delete saved data

- Press **Settings > Basic function settings > Delete** and then **Accept**.

WARNING

Select the settings, enter the destination and the modifications for navigation only with the vehicle at a standstill.

Note

- If a detour is passed during route guidance, navigation may recalculate the route.
- The quality of the navigation recommendations given by the Infotainment system depends on the navigation data available and any reported traffic congestions.
- Navigation announcements are not emitted if the sound is muted in the infotainment system.

Navigation functions and symbols

Navigation

Navigation functions depend on the equipment and country.





Functions







- Entering the destination and route calculation (offline and online).
- Display of two navigation maps at the same time (screen and instrument cluster).
- Update of online maps.
- Predictive navigation.
- 3D urban maps.
- Online traffic information.
- Dynamic POIs (points of interest).


Symbols on the map


The buttons and indications depend on the settings and the current driving situation.

Symbols for traffic events and points of interest (POIs) are displayed on the map, for example, petrol stations, train stations or interesting stopovers, provided navigation has such data **>>> page 274**.

-  Current position.
-  Search for destinations.
-  Destinations along the route.
-  Final destination.







-  Home address.
-  Work address.
-  Favourite destinations.
-  Additional window with more options.
-  Additional window with route options.
-  Centre the map on the current position.

-  Change view: 2D oriented to the north, or 2D oriented to the direction of travel, or 3D to the direction of travel.



-  Information about the current route guidance.





-  Map scale.

Symbols in the additional window



- To open the additional window, press .
-  Repeat the last navigation announcement.
-  Volume of navigation announcements.
-  Map lighting in Automatic, Day or Night mode.
-  Offer new guidance routes.
-  360° electric range indicator (hybrid vehicles)

Other symbols

-  Entering the detailed destination for an address.
-  Search for destinations.

-  Frequent destinations.
-  Last destinations.
-  Favourite destinations.
-  Back






Symbols in the route details

-  Current position.
-  Destination of the current guidance.

POI symbols (points of interest)

POIs (points of interest) are shown on the map, provided the navigation has said data.

Click on the desired POI (point of interest) to start a route guidance **>>> page 272**.










-  Petrol station.
-  Parking lot.
-  Tourist information offices.
-  Train station.
-  Restaurant.

Traffic information.

POIs (points of interest) are shown on the map, provided the navigation has said data **>>> page 274**.

Click on a traffic event to open an additional window with further details **>>> page 274**.

-  Slow traffic.

-  Traffic jam.
-  Accident.
-  Broken down vehicle.
-  Slippery surface (ice or snow).
-  Road closed to traffic.
-  Slippery road hazard.
-  Danger.
-  Road works.
-  Strong wind.
-  Reduced visibility.

Navigation data

The Infotainment system is equipped with a built-in navigation data memory. Depending on the country, the necessary navigation data may already be pre-installed.

To provide correct route guidance and make the most of the functions offered, the infotainment system should be updated on a regular basis.

Using obsolete data may lead to errors during navigation. Current routes cannot be traced or the route guidances will lead to mistaken destinations.

Ensure navigation data is updated at all times.

Online updating of navigation data

The navigation data of the regions through which you travel frequently is automatically updated in the background if the Internet connection is established and the privacy settings are valid.

- With the ignition switched on, the navigation data is updated automatically.

Manual update of navigation data

Current navigation data for large regions, for example Western Europe, can be downloaded from www.seat.com and stored on USB data devices.

- Download the navigation data to a USB data device.
- Turn on the ignition of the vehicle.
- Connect the USB data device to the infotainment system. Navigation data is automatically updated in the background.

The map version is displayed in **HOME** >  > **System information**.

WARNING

If you update the navigation data manually while driving, it may cause accidents with serious injuries.

- Update the navigation data only with the vehicle at a standstill.

Note

Automatic update of the navigation data is subject to the privacy settings. No update is made in incognito mode.

Start route guidance





Depending on the country and equipment, different functions are available to enter destinations.


The different functions for entering destinations are found in the navigation main menu.

Opening the Navigation main menu

- Press **HOME** > .

Select the destination and start navigation

1. Press .
2. Select the desired destination. You can choose from  **Frequent destinations**,  **Last destinations** or  **Favourite destinations**.

OR: press  and enter the address in the input screen.



OR: detailed address.

3. Press **Start**.

Frequent destinations

The destination synopsis uses recorded data to propose possible destinations.

Select the destination and start navigation:



1. Press  and then .
2. Select the desired destination. The route guidance starts automatically.

Quick start: for a quick start, press and hold the desired destination for a few seconds.

Recent destinations

Navigation saves the last destinations to make them available for a route guidance.

Select the destination and start navigation:

1. Press  and then .
2. Press the desired destination.
3. Press **Start**.

Quick start: for a quick start, press and hold the desired destination for a few seconds.


Delete “Last Destinations”

From the menu  **Last destinations:**



1. Slide your finger over the destination to be deleted “X” will appear on the selected destination.
2. Click on “X” to delete it.
3. Use the same method to delete whichever **Last destinations** that you want.

Favourite destinations

Save up to 20 destinations as favourites.

To save a destination as a favourite press  in the split screen when entering the destination.

Select the destination and start navigation:

1. Press  and then .
2. Press the desired destination.
3. Press **Start**.

Note

Enter the destination as accurately as possible. If you enter a destination incorrectly, the route guidance will not be able to start or it will guide you to an incorrect destination.


Start route guidance by selecting from the map

The navigation map includes active areas at many points that are suitable for entering the destination. To do this, press the desired position or place on the map. If there is map data at this point, you can start a route guidance.

Whether it is possible to enter the destination through the navigation map depends on the state of the data and it is not possible for all positions.

To start “offroad navigation”, press an empty area without position data.

Start navigation:

1. Press .
2. Move the view on the map until the desired position can be selected. The navigation map can be used by means of additional finger movements **»» page 269**.
3. Press the desired destination on the map.
4. Press **Route**.

Offroad navigation

“Offroad navigation” calculates routes to selected destination points using unknown data. When a destination point is outside the known roads or position data, navigation finds the route to the next point of the known road and completes the path to the next destination point with a direct connection.


Start navigation:

1. Move the view on the map until the desired position can be selected. The navigation map can be used by means of additional finger movements **»» page 269**.
2. Press on any point on the map without position data.
3. Press **Route**.

Start route guidance using contact details

Start route guidance with the saved address data of a contact. Contacts saved without address data cannot be used for route guidance.

Start navigation:

1. Press .
2. Press on the contact you want.
3. Press **Route**.

Note

If the address details of a contact are obsolete, the route guidance will nevertheless take you to the registered address. Check that the contact address is updated.

Traffic information

The infotainment system receives detailed traffic information automatically if the Internet connection is established. This information is shown with symbols and highlighting the road network in colour on the map.

Traffic incidents

Traffic incidents, for example, traffic jams or congested traffic, are shown on the navigation map using symbols.

With an active route guidance, traffic incidents that are on the current route are shown in the route details. Such traffic incidents can be avoided >>> [page 274, Function descriptions](#).

Hazard information

Hazard information is shown on the navigation map with symbols in the same way as traffic incidents. In this case, the source of this information is another vehicle that has detected the hazard and has uploaded the information to the service provider.

The hazards shown are: accident, broken down vehicle and slippery road surface.

Traffic flow indication

The navigation map shows traffic flow according to current traffic events, highlighting the road network in colour.

- **Yellow:** Slow traffic.
- **Red:** Traffic jam.

Note

Traffic information receipt is subject to the privacy settings. In maximum Privacy mode, no traffic information is received. Tracking or Location level setting is necessary.

Function descriptions

Route details

The route details contain information on all incidents, for example, the starting point, stopovers, traffic events, POIs and destination, provided the navigation has such data.

If you press on an incident, an additional window opens providing more options. The available options depend on the incident and the current settings.

Open and close the route details

- To open them, press | or swipe it.
- To close them, press | or swipe it.

Edit route guidance

To edit the route guidance, move the stopovers to the destination in the TripView view.

- Hold the desired destination pressed until it is visibly highlighted.
- Move the destination to the desired position.
- Remove your finger from the screen. The route will recalculate.

Avoid traffic incidents

The details of the route show the current traffic incidents if the navigation has such data. Avoid traffic incidents by editing route details >>> [page 274](#).

- Press on a traffic event.
- Press on **Avoid**. The route will recalculate.

Split screen

When handling navigation functions, an additional window with other options may open. Possible options depend on the function being used.

Close the additional screen

- Press on an empty area outside the additional window.
- **OR:** press X.
- **OR:** press **Accept**.

Functions in the additional window:

Show on map	Show what is selected on the map.
Add stop-over destination	Add a stopover to the route guidance.
Direct route	Starts direct route guidance.
Delete	Delete a stopover from the route guidance.
Avoid	Avoid traffic jam. The route will recalculate.
Stop route guidance	Ends the current route guidance.
X	Close the additional window.
☆	Add a destination to favourites.

Learn usage pattern

When the vehicle is in motion, navigation saves routes and destinations used to automatically generate destination proposals. Destinations are learned based on the time of day and the day of the week.

Navigation can propose up to 5 routes at the same time. The proposed routes may be different from the routes of the normal route guidance.

If one of the proposed destinations is selected, the guide to that destination is started.

The route guidance follows the selected route until the vehicle deviates from it. In that case, the route is recalculated and takes you back along the most direct path to the initially selected destination.

Important traffic jams are taken into account in the route guidance, and are avoided if alternative routes are available, provided navigation has such data.

You can activate and deactivate the function whenever you want.

Enable and disable learning usage pattern

The setting is in the corresponding navigation menu **⚙ > Basic function settings**.


- To activate the function, activate **Learn usage pattern**.
- To disable the function, disable **Learn usage pattern**.
- To delete saved data, press **Delete usage pattern**.

360° electric operating range display

Valid for: vehicles with plug-in hybrid drive

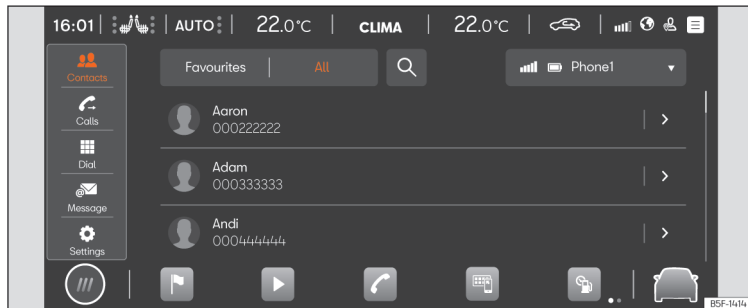
The 360° electric operating range display shows the possible range with the current charge level of the high voltage battery.

Switch on the 360° electric operating range display

- Open the additional map window and press the symbol .

Telephone interface

Introduction



You can use the telephone interface to connect your mobile to the infotainment system and operate phone functions through it. The sound is played through the vehicle's speakers.

You can connect up to two mobile phone devices simultaneously to the infotainment system.

High speeds, poor weather or road conditions and a noisy ambience (even outside of the vehicle), as well as the quality of reception can all affect the quality of a telephone conversation in the vehicle.

Note

- As a general rule, pairing a device (for example, a mobile phone device) is only necessary once. You can restore the device connection via Bluetooth® or Wi-Fi with the infotainment system whenever you want without having to pair the device again.
- The availability of some telephone functions will depend on the mobile phone connected to the infotainment system.

Fig. 178 Schematic diagram: Phone view.

Telephone interface equipment and symbols

Equipment features

- Hands-free function.
- Use up to two phones at the same time.
- Phone book with up to 5,000 contacts, depending on the infotainment system.
- SMS functions via Bluetooth®: SMS reading, SMS writing (templates included), SMS playback, message history.
- Email functions via Bluetooth®: reading email, writing email.

- Connection to wireless charging option.
- Connection to the microphone mounted on the vehicle.

Symbols in the main menu

- Contacts.
- List of incoming and outgoing calls.
- Enter telephone number.
- Text messages (SMS and emails).
- Telephone interface settings.

Symbols for calls

The symbols may be different depending on the infotainment system.

- Start a call or bringing it to the foreground.
- End or reject a call.
- Open contact list or Start conference call.
- Enter telephone number.
- Mute the sound of the hands-free
- Hold call.
- Continue call.
- Pass call to private mode.
- Make an emergency call.
- Voice mail.
- Get help in case of breakdown.
- Obtain information on the SEAT brand and selected additional services related to traffic and your travel.

Call list symbols

- To open the call lists, press .
- Incoming call.
- Outgoing call.
- Missed call.
- Telephone number (company).
- Telephone number (private).
- Mobile telephone number (company).
- Mobile telephone number (private).
- Fax (private).
- Fax.

Symbols for text messages

The symbols may be different depending on the infotainment system.

- To open the text messages, press .
- Activate voice control input **>>> page 260.**
- Templates for text messages.

Places with special regulations

Switch off the mobile telephone and the telephone interface in places with a risk of explosion. These places are not always clearly marked. They include, for example:

- The vicinity of chemical pipelines and tanks.
- The lower decks of boats and ferries.

- In the proximity of vehicles that run on liquefied gas (such as propane or butane).
- Places where the air is laden with chemicals or particles such as flour, dust or metal powder.
- All other places where the engine or telephone must be switched off.

WARNING

Switch off the mobile phone in areas with a risk of explosion!

Note

In areas where special regulations apply or the use of mobile phones is forbidden, it must be switched off at all times. The radiation produced by the mobile phone when switched on may interfere with sensitive technical and medical equipment, possibly resulting in malfunction or damage to the equipment.

Pair, connect and manage

Requirement for pairing:

- Bluetooth® is activated on the mobile phone device.
- Bluetooth® is activated on the infotainment system.
- Depending on the mobile device, it will be necessary to have the Bluetooth® menu open or activate the **Visibility** option so that the device is visible from the infotainment system.

Pair a mobile phone device suitable for telephony with the infotainment system to use the telephone interface functions. On the first connection, the mobile phone device is paired with the infotainment system. Doing so saves a user profile »» page 278, *User profiles*.

The pairing can take a few minutes. The functions available depend on the mobile phone device used and its operating system.

Pair a mobile phone device

1. Open the list of available Bluetooth® devices on the mobile phone device and select the name of the infotainment system.
2. Please note and, if necessary, confirm the messages that appear on the mobile phone device and on the infotainment system. If the pairing was successful, the phone data is saved in the user profile.
3. *Optional:* confirm the data transfer message on the mobile phone device.

Active and passive connection

To use the functions of the telephone interface, there must be at least one mobile phone device connected to the infotainment system. If there are several mobile phone devices connected to the infotainment system, you can switch between active and passive connections. To use the telephone interface with the desired mobile phone device, establish the active connection with the infotainment system.

Difference between connection types

Active The mobile phone device is paired and connected. The functions of the telephone interface are performed with the data of said mobile phone device.

Passive The mobile phone device is paired and connected. Calls can be managed but the phone book, messages or other functions will not be active.

Paired mobile phone devices are stored in the infotainment system, even if they are not currently connected.

Connect a mobile phone device

Requirement: the mobile phone device is paired with the infotainment system.

- Bluetooth® is activated on the mobile phone device.

Establish an active connection

Requirement: several mobile phone devices are connected to the infotainment system at the same time.

- Select the desired mobile phone device from the drop-down menu. All other mobile phone devices are automatically in the passive connection.

User profiles

For each of the paired mobile phone devices an individual user profile is automatically created. In the user profile, data from the mobile phone device is stored, for example, contact details or settings. A maximum of four user profiles can be saved in the infotainment system at the same time.

WARNING

If you perform the pairing while driving, it could cause an accident or injury.

- Perform pairing only with the vehicle at a standstill.

Note

- While the infotainment system is in the **Known mobile phones** menu, the wireless charging function is disabled. When you exit this menu, the wireless charging function is activated again.
- In the pairing of some mobile phone devices, a PIN number is shown on the screen of the mobile phone device. Enter that number in the infotainment system to complete the pairing.

Basic and Comfort Telephony

Depending on the equipment, two types of telephone interface can be used:

- Basic telephone interface.
- Comfort telephone interface.

Basic telephone interface

The Basic telephone interface uses the Bluetooth® HFP profile for transmission. This interface allows the use of telephone functions through the infotainment system and playback through the vehicle's speakers.

Comfort telephone interface

Like the Basic telephone interface, the Comfort telephone interface also uses the Bluetooth® HFP profile.

The Comfort phone interface can be equipped with the wireless charging function
>>> page 280.

In order to use the functions of the wireless charging function, you have to place a suitable mobile phone device correctly in the storage compartment. The mobile phone device will then connect to the vehicle antenna. This improves the reception and sound quality of calls.

Calling and sending messages

Open the telephone interface


- Press **HOME** > .


Make a call

Select a phone number to start a call. Different functions are available for selecting a phone number:

Contacts

If a contact has several registered phone numbers you have to select one.


- Press  and press a number on the list to start the call.


OR: press  and enter the contact name in the input field to search for it. Press on the contact to start the call.

OR: press a favourite in the telephone interface main menu to start the call.

Calls



The telephone interface shows the call list of the mobile telephone device. Start a call from the call list.


- Press  > **All** and press a number on the list to start the call.

OR: press  and filter the call list entries (for example, missed calls or dialled numbers). In filtered list, press a number to start the call.

Dial number

Manually enter a phone number to start a call. While entering the phone number, contacts that match that number are shown on the infotainment screen.


- Press  and enter the telephone number. Press  to start the call.

The last call is dialled by pressing and holding the  button on the multifunction steering wheel.


Send messages

Depending on the mobile phone device and the infotainment system used, you can send and receive SMS and e-mails through the telephone interface.

Send an SMS:

1. Press  > **Text message** > **Enter new message** and enter the message on the screen.
2. Enter the contact you want in the search bar.
3. To send the message press **OK**.

Send an email:

- Press  > **E-mail** > **Enter new message** and enter the message on the screen.
- Enter the contact you want in the search bar.
- To send the message press **OK**.

Phone book, favourites and speed dial buttons

In the first connection of a telephone with the infotainment system, the phone book is saved in the infotainment system. It may be necessary to confirm the data transmission on the mobile phone.

Each time the phone is reconnected, the phone book is updated.

If conference calls are supported, the phone book can be accessed during a call. If there is a saved image for a contact, it can be displayed in the list next to the entry.

Favourites

A speed dial button can be assigned to a phone book favourite up to a maximum of six. If there is a registered photo saved to the contact, it is shown on the speed dial button.

All speed dial buttons have to be manually edited and will be assigned to a user profile »» page 277.

Assign the speed dial button

- In the **Favourites** menu, press the **+** button, then open the phone book to select a contact as a favourite. If the contact has several phone numbers, press on the number in the list.

¹⁾ It only includes the wireless charge functionality.

²⁾ Qi technology allows you to charge your mobile phone wirelessly.

Edit the speed dial button

- To edit or delete a favourite contact press on the icon  in the **Favourites** menu screen. You can delete one or more favourites.

Call a favourite

- Press the assigned speed dial button.

Note

Favourites are not updated automatically. If you change a contact's phone number, you have to reassign the speed dial button.

Connectivity Box



Fig. 179 On the centre console: pad for the mobile phone connection.


The Connectivity Box includes different functions that will help to use your mobile device. These are:

- *Wireless Charger*¹⁾.
- *Signal amplifier / (Mobile Signal Amplifier)*

Wireless charger

The Wireless Charger allows mobile devices with Qi²⁾ technology to be charged without a cable.

To charge your mobile phone wirelessly:

- Place your mobile device in the middle of the pad with the screen facing up »» **Fig. 179**, »» .

Make sure there are no objects between the pad and the mobile phone.

The mobile phone will start charging automatically. For further information about whether your mobile device uses Qi technology, check your phone's user manual or visit the SEAT website

Mobile Signal Amplifier

It allows you to reduce radiation in the vehicle and have better reception.

For safety reasons, it is recommended that you pair the system and the mobile using Bluetooth® and place it on the Connectivity Box pad, for the best reception without having to handle the mobile phone.

For connection to the vehicle's external antenna:

- Place your mobile device in the middle of the pad with the screen facing up »» Fig. 179 , »» ⚠.

Make sure there are no objects between the pad and the mobile phone.

Your mobile phone will automatically be able to use the external antenna function.

⚠ WARNING

Notifications on the screen of the mobile device can distract the driver's attention and increase the risk of a serious accident.

- Only place one suitable mobile device, with Qi compatibility if applicable. To ensure that it operates properly, place it without the protective case and ensure that it has maximum dimensions (width x length) of 80 x 140 mm (3.15 x 5.512 inches) on the base of the Connectivity Box as indicated.
- If the mobile device is not placed on the base of the Connectivity Box, in the correct position, or if its dimensions exceed those specified, it may not be recognised or may not charge correctly. Under certain circumstances, the infotainment system indicates

that there is a foreign object in the storage compartment. Using a suitable mobile phone device and correcting its position can eliminate the fault.

- If necessary, remove any objects that may obstruct the cover's closing function.

⚠ WARNING

- The mobile phone may become warm due to wireless charging. Think about this before you pick it up, and take care when removing it.
- There must be no metallic or other objects between the mobile phone and the housing, to prevent the functionality of the Connectivity Box from being affected.

ⓘ NOTICE

The base of the Connectivity Box is not removable.

ⓘ Note

- Your mobile device must support the Qi inductive charging interface standard for proper operation.
- Charging time and temperature varies depending on the device that is used.
- The maximum charging capacity is 15W.
- Qi technology does not allow simultaneous charging of more than one mobile device.

• No improvement in reception can be guaranteed if there is more than one mobile phone on the pad.

- You are advised to keep the engine running to guarantee proper wireless charging.
- When a telephone with Qi technology is connected by USB, it will be charged by the means specified by the manufacturer.

Storing objects

Positioning the luggage and cargo

General information

Placing luggage inside the vehicle safely

It is possible to carry objects and luggage in the vehicle, in a trailer »» page 294 and on the roof »» page 292. When doing so, please consider all legal provisions.

- Distribute the load in the vehicle as evenly as possible.
- Always place luggage and heavy objects as far forwards as possible in the luggage compartment »» ⚠.
- Take into account the maximum authorised weight per axle, as well as the maximum authorised weight of the vehicle »» page 381.
- Secure the objects to the fastening rings of the boot using appropriate chains or belts »» page 289.
- Also place small objects safely.
- In vehicles with dynamic headlight range control, the lights adapt automatically.
- Adapt tyre pressure to the load. Take into account the pressure sticker of the tyres »» page 347.

- In vehicles equipped with tyre pressure control system, adjust to the new load status if necessary »» page 357.

⚠ WARNING

Loose or unsecured objects can cause serious injury in case of sudden manoeuvring or braking or in case of an accident. Particularly if the airbag hits them when deploying and they are thrown across the inside of the vehicle. Please observe the following rules to minimise the risk of injury:

- Place all objects inside the vehicle safely.
- Secure all objects, little and large.
- Place the objects in the cabin in such a way that they can never reach the airbag deployment areas while the vehicle is in motion.
- Keep the storage compartments closed at all times while the vehicle is in motion.
- Place the objects in such a way that they never force any occupant of the vehicle to sit in an incorrect position.
- When transporting objects that take up a seat, never let anyone use that seat.
- Never leave hard, sharp or heavy objects loose in open storage compartment of the vehicle, on the cover behind the rear seat or on the instrument panel.
- Remove all hard, sharp or heavy objects from the fabrics and bags inside the cabin and store them safely.

⚠ WARNING

The transport of heavy object changes vehicle handling and increases braking distance. Heavy objects that are not properly placed or secured may cause loss of control of the vehicle and thus severe injuries.

- Never put too much load in the vehicle. Both the carrying capacity as well as the distribution of the load in the vehicle have effects on the driving behaviour and braking ability.
- When transporting heavy objects, the driving behaviour of the vehicle varies due to the displacement of the centre of gravity.
- Always distribute the load in the vehicle as evenly and horizontally as possible.
- Always place heavy objects in the boot before the rear axle and as far away from it as possible.
- Objects in the luggage compartment that are unsecured could move suddenly and modify the handling of the vehicle.
- Adapt your speed and driving style at all times to suit visibility, weather, road and traffic conditions.
- Accelerate with particular care and caution.
- Avoid sudden braking and manoeuvres.
- Brake earlier than usual.

NOTICE

Electrical wires or, depending on the features, the antenna embedded into the rear windows could be damaged, even irreparably, if they are in contact with objects.

Note

Straps for securing the load to the fastening rings are commercially available from accessory shops.

Luggage compartment

Luggage compartment shelf

✓ Valid for: Leon

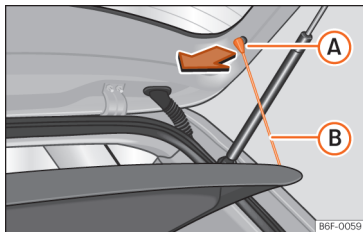


Fig. 180 In the boot: removing and installing the shelf.

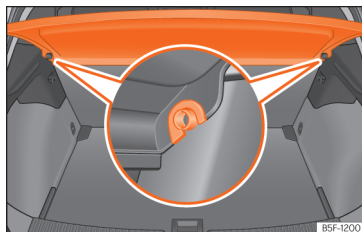


Fig. 181 In the boot: removing and installing the shelf.

Removing

- Detach the cord loops >>> Fig. 180 (B) from their hooks (A).
- Remove the rear shelf from the side supports >>> Fig. 181 by pulling it upwards and then take it out.

If necessary, the rear shelf can be stored under the luggage compartment double floor >>> page 284.

Fitting

- Insert the cover horizontally so that the "recess" fits onto the axis of the supports >>> Fig. 181 and press down until it engages.
- Attach the securing straps >>> Fig. 180 (B) onto the rear lid.

WARNING

Animals, loose or unsecured objects carried on the rear shelf can cause serious injury in case of sudden manoeuvring or braking or in case of an accident.

- Do not leave hard, sharp or heavy objects or in bags on the rear shelf.
- Never transport animals on the rear shelf.

NOTICE

- Before closing the rear lid, ensure that the rear shelf is correctly fitted.
- An overloaded luggage compartment could mean that the rear shelf is not correctly seated and it may be bent or damaged.
- If the luggage compartment is overloaded, remove the tray.

Note

Ensure that, when placing items of clothing on the luggage compartment cover, rear visibility is not reduced.

Store the rear shelf

✓ Valid for: Leon

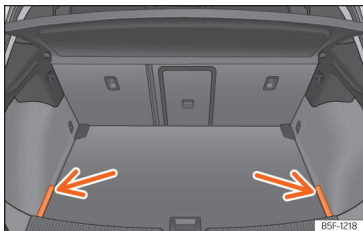


Fig. 182 In the boot: covers for storing the rear shelf.



Fig. 183 In the boot: fitting the rear shelf.

Depending on the equipment, once the luggage compartment shelf has been removed, it can be stored under the boot floor.

- Remove the left and right covers »» **Fig. 182**.
- Place the rear shelf in the corresponding housing »» **Fig. 183**.
- Put the left and right covers in their original position.

Retractable shelf

✓ Valid for: LEON Sportstourer

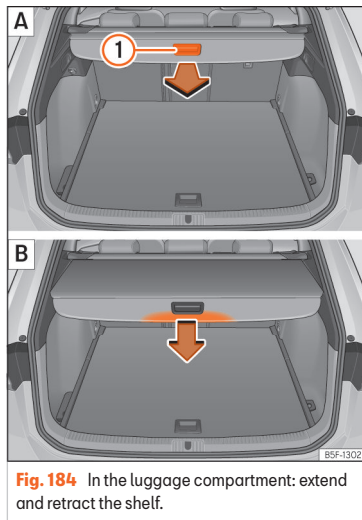


Fig. 184 In the luggage compartment: extend and retract the shelf.

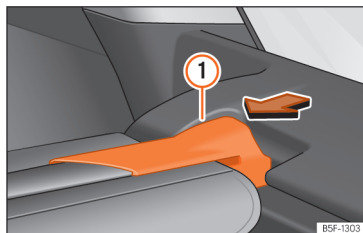


Fig. 185 In the luggage compartment: remove the shelf.

Extending the shelf

- Pull evenly on the rear shelf using its handle »» **Fig. 184** ① in a backwards direction until it audibly clicks into place.

Retracting the rear shelf

- Press on the handle of the rear shelf in the direction of the arrow to release it »» **Fig. 184** B.

The shelf will automatically move towards the end and will retract completely.

Removing the shelf

- Press the rear shelf support »» **Fig. 185** ① in the direction of the arrow.
- Pull the rear shelf up and out of the support.

- The tray can be stored under the variable floor of the luggage compartment, which must be in its upper position >>> **page 285**.

Fitting the shelf

- Place the rear shelf in the housing provided in the left or right side cover.
- Engage the support of the rear shelf >>> **Fig. 185** ① into the housing on the other side.
- Check that the support is properly engaged.

⚠ WARNING

Animals, loose or unsecured or objects carried on the rear shelf can cause serious injury in case of sudden manoeuvring or braking or in case of an accident.

- Do not leave hard, sharp or heavy objects or in bags on the rear shelf.
- Never transport animals on the rear shelf.

ⓘ NOTICE

To retract the rear shelf, press on its handle in a downwards only direction; if you press it upwards it may lead to its axles breaking.

Storing the retractable shelf

✓ Valid for: Leon Sportstourer except PHEV versions

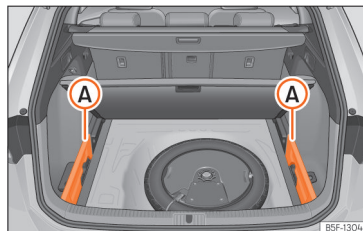


Fig. 186 In the boot: space to store the retractable shelf.

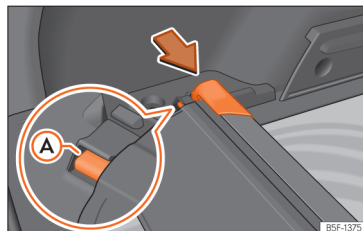


Fig. 187 In the boot: space to store the retractable shelf.

The retractable shelf can be stored under the luggage compartment variable floor.

- Remove the left and right covers >>> **Fig. 186** ①.
- Press the head of the retractable shelf in the direction of the arrow until it engages in its housing >>> **Fig. 187**. Make sure that slide ① fits into the corresponding housing.
- Put the left and right covers in their original position.

Variable luggage compartment floor

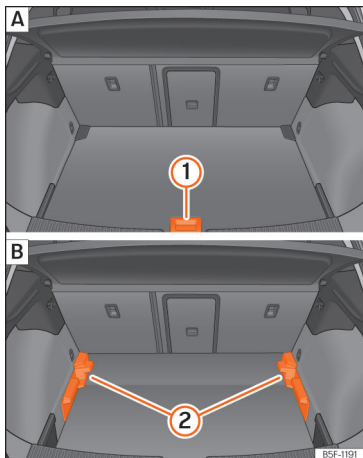


Fig. 188 Variable luggage compartment floor:
A raised position; **B** lowered position.

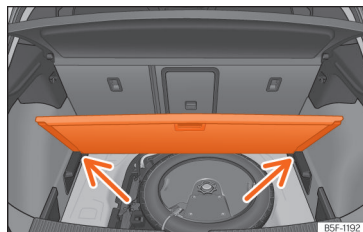


Fig. 189 Variable boot floor: tilted position.

Variable floor in high position

- To move from the low position to the high position, lift the floor using the handle »» **Fig. 188** ①, and pull it back until the front of the floor has fully passed the supports ②.
- Move the floor forward over the supports as far as the rear seat backrest and then lower the floor with the handle ①.

Variable floor in low position

- To move from the high position to the low position, lift the floor using the handle »» **Fig. 188** ①, and pull it back until the front of the floor has fully passed the supports ②.
- Now let the front part fall to the floor and slide the floor forwards as far as the rear seat backrest; lower the floor at the same time with the handle ①.

Variable floor in the tilted position

When the variable floor is tilted you can access the spare wheel or anti-puncture kit area.

- Lift the variable floor in the high position using handle »» **Fig. 188** ①, pull it up and push it towards the backrest of the rear seats until it folds along the hinge line and the movable part of the floor is resting on itself.
- Rest the floor on its housings »» **Fig. 189** (arrows).

⚠ WARNING

- Always secure objects, even when the luggage compartment floor is properly lifted.
- Only objects that do not protrude more than 2/3 the height of the floor may be carried between the rear seat and the raised luggage compartment floor.
- Only objects that do not weigh than approximately 7.5 kg may be carried between the rear seat and the raised luggage compartment floor.

NOTICE

- The maximum weight that can be loaded on the luggage compartment variable floor in the top position is 100 kg.
- Do not let the luggage compartment floor fall when closing it. Always carefully guide it downwards in a controlled manner. Otherwise, the lining and the floor of the luggage compartment could be damaged.

Net partition

Partition net behind the rear seat

✓ Valid for: LEON Sportstourer

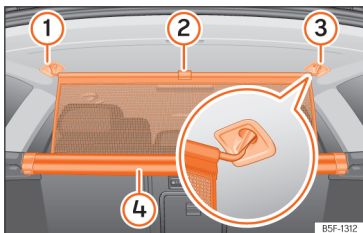


Fig. 190 In the boot: securing the partition net.

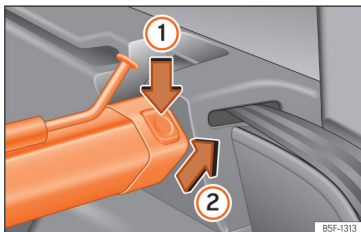


Fig. 191 In the boot: removing the partition net.

Pulling out and securing the net partition

- Pull up handle >>> Fig. 190 ② to remove the net from the casing ④.
- Hook in the net partition on the right or left side ③ [magnified image].
- Hook in the net partition into the housing on the other side ① by pulling the rod.

The net partition is properly assembled when the T-shaped ends are firmly secured in the corresponding housings ③ and ①.

Retracting the net partition

- Unhook the rod from the housings ③ and ①.
- Roll up the net into the casing ④ lowering it with your hand.

Removing the net partition

- Fold the rear seat backrests forward.
- Press the left or right release catch >>> Fig. 191 in the direction of the arrow ①.
- Remove the casing from the support in the direction of the arrow >>> Fig. 191 ②.

Fitting the net partition

- Fold the rear seat backrests forward.
- Fit the casing in the right and left supports.
- Press the casing into the left and right supports in the opposite direction to the arrow >>> Fig. 191 ② until it engages. The red markings on the release buttons should no longer be visible.

WARNING

- Always secure objects, even when the net partition is properly assembled.
- There should be nobody behind the assembled partition when the vehicle is moving.
- The attachments on the backs of the rear seats must never be used to fit the net partition when the rear seat backs are in their vertical position.

NOTICE

Incorrect handling of the net partition could cause damage.

- Do not release the net partition when lowering it, as the net and other vehicle parts could be damaged. Roll down the net partition by hand.

Net partition with the rear seat backs folded down.

✓ Valid for: LEON Sportstourer

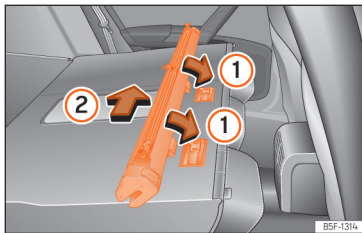


Fig. 192 Assembling the net partition in the rear seat backrests.

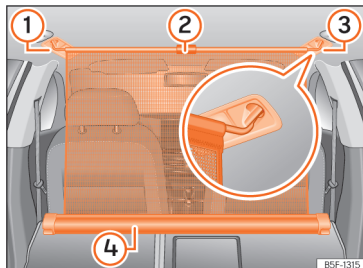


Fig. 193 In the boot: net partition hooked into the rear seat backrests.

Fitting the net partition

- Fold the rear seat backrests forward.
- Remove the net partition from the side supports.
- Place the net casing in the rail slots in the direction of the arrows »» Fig. 192 ①.
- Push the casing towards the left side of the vehicle in the direction of arrow »» Fig. 192 ②.
- Check that the net is secure.

Pulling out and securing the net partition

- Pull up handle »» Fig. 193 ② to remove the net from the casing ④.
- Hook in the net partition on the right or left side »» Fig. 193 ③ (magnified image).

- Hook in the net partition into the housing on the other side »» Fig. 193 ① by pulling the rod.

The net partition is properly assembled when the T-shaped ends are firmly secured in the corresponding housings »» Fig. 193 ③ and ①.

Retracting the net partition

- Remove the rod from the housings in the trims of the roof side members.
- Roll up the net into the casing »» Fig. 193 ④ lowering it with your hand.

Removing the net partition

- Pull the net casing out approximately 5 cm in the opposite direction to the arrow »» Fig. 192 ②.
- Remove the casing from the rails by pulling in the opposite direction to the arrows »» Fig. 192 ①.
- Lift the rear seat backrests.

WARNING

During a sudden driving or braking manoeuvre, or in the event of an accident, objects could be flung through the interior and cause serious or fatal injuries.

- Always secure objects, even when the net partition is properly assembled.
- There should be nobody behind the assembled partition when the vehicle is moving.

⚠ WARNING

The rear seat backrests should only be lifted again once the net partition has been disassembled.

ⓘ NOTICE

Incorrect handling of the net partition could cause damage.

- Do not release the net partition when lowering it, as the net and other vehicle parts could be damaged. Roll down the net partition by hand.

Luggage compartment equipment

Fastening rings

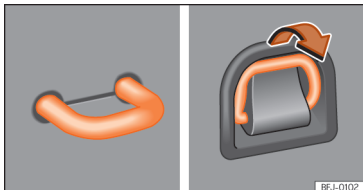


Fig. 194 In the luggage compartment: fastening rings.

There are fastening rings »» Fig. 194 on the front and rear of the boot to secure loose objects and luggage with fastening belts and cords.

⚠ WARNING

If unsuitable or damaged belts or retaining straps are used, they could break in the event of braking or an accident. Objects could then be launched across the passenger compartment and cause serious or fatal injuries.

- Always use belts or straps that are suitable and in good condition.
- Tighten the belts and straps in a cross layout over the load placed on the boot floor and secure them to the fastening rings safely.
- Never exceed the maximum tensile load of the fastening rings when securing objects.
- Make sure that, particularly for flat objects, the upper edge of the load is higher than the fastening rings.
- Depending on the features, take into account the instruction panels on the boot on how to place the load.
- Never secure a child seat to the fastening rings.

ⓘ Note

- The maximum tensile load that the fastening rings can support is approx. 3.5 kN.
- Belts, straps and securing systems for the appropriate load can be obtained from specialised dealerships. SEAT recommends visiting a SEAT dealership for this.

Net bag

✓ Valid for: LEON Sportstourer

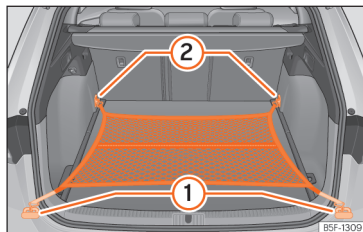


Fig. 195 In the boot: net bag hooked up at floor level.

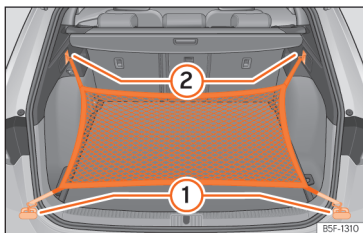


Fig. 196 In the luggage compartment: rings ① and hooks ② for attaching the net bag.

The luggage compartment prevents light luggage from moving. The net bag has a zip and can be used to store small objects.

The net bag can be hooked up to the luggage compartment in different ways.

Hooking the net bag into the luggage compartment floor

If necessary, the front eyes must be unfolded first »» page 289.

- Secure the net hooks to the fastening rings »» Fig. 195 ① and ② »» ⚠. The bag zip should be facing upwards.

Hook the net bag next to the load threshold

- Secure the short net hooks to the fastening rings »» Fig. 196 ① »» ⚠. The bag zip should be facing upwards.
- Secure the straps in the bag hooks ②.

Removing the net bag

The hooked up net bag is taut »» ⚠.

- Release the net bag from the fastening rings.
- Store the net bag in the luggage compartment.

⚠ WARNING

To secure the elastic net bag on the fastening rings of the boot it must be stretched out. Once hooked up it is taut. If the net bag is hooked up or unhooked incorrectly the hooks could cause injuries.

- Always secure the bag hooks properly so that they do not suddenly release from the fastening rings when hooking or unhooking them.
- On hooking or unhooking them, protect your eyes and face in case the hooks are released suddenly.
- Always hook up the net bag hooks in the described order. Unfastening a hook suddenly can cause injuries.

Bag hooks

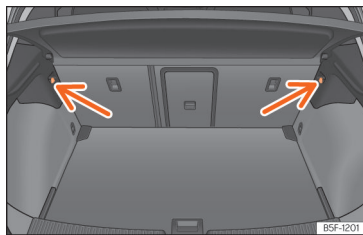


Fig. 197 In the boot: bag hooks (Leon).

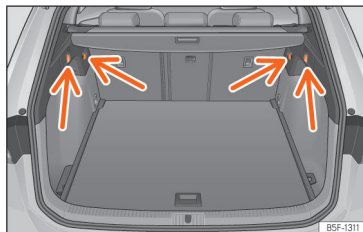


Fig. 198 In the boot: bag hooks (Leon Sportstourer).

There may be hooks for hanging bags on both sides of the luggage compartment »» Fig. 197.

The retaining hooks have been designed to secure light shopping bags.

⚠ WARNING

Never use the hooks to hang luggage or other objects. In case of sudden braking or an accident, the hooks could break.

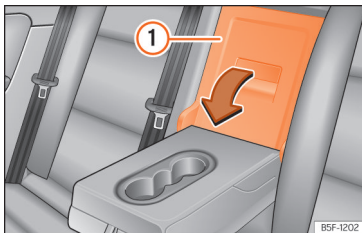
Trapdoor for transporting long objects

Fig. 199 On the rear seat backrest: opening the tailboard.

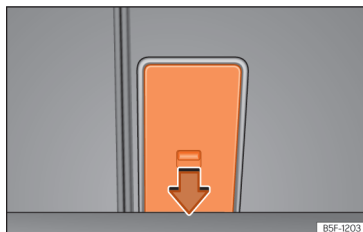


Fig. 200 In the boot: opening the tailboard.

On the rear seat, behind the central armrest, there is a tailboard for transporting long items in the interior, such as skis.

Opening the tailboard

- Lower the centre armrest.
- Pull the release lever in the direction of the arrow and push the tailboard cover >>> **Fig. 199** ① down and forwards.
- Open the rear lid.
- Insert the long objects through the gap from the luggage compartment.
- Secure the objects with the seat belt.
- Close the rear lid.

Closing the tailboard

- Lift the tailboard cover until it engages. The red mark on the luggage compartment side should never be visible.

- Close the rear lid.
- Lift the centre armrest if necessary.

⚠ WARNING

The presence of objects in the central airbag deployment area can prevent it from operating properly and can cause serious injury.

- Do not leave any objects in the central airbag deployment zone >>> page 56.

⚠ WARNING

- When the armrest is down, nobody should travel in the centre seat of the rear bench.
- Do not use the hatch while driving.
- When lowering or raising the hatch, take particular care with your hands and do not trap or damage the seatbelt.

i Note

The tailboard can also be opened from the luggage compartment. To do so, press the release lever down, in the direction of the arrow, and the cover upwards >>> **Fig. 200**.

Roof carrier

Introduction

The vehicle roof has been designed to optimise aerodynamics. For this reason, cross bars or conventional roof carrier systems cannot be secured to the roof water drains.

As the roof water drains are integrated in the roof to reduce air resistance, only SEAT-approved cross bars and roof carrier systems can be used.

Cases in which cross bars and the roof carrier system should be disassembled.

- When they are not used.
- When the vehicle is washed in a car wash.
- When the vehicle height exceeds the maximum height, for example, in some garages.

WARNING

- Always secure the load properly using belts or retaining straps that are suitable and in a good condition.
- Bulky, heavy, long or flat loads have a negative effect on aerodynamics, the centre of gravity and driving performance.
- Avoid sudden braking and manoeuvres.
- Adapt your speed and driving style at all times to suit visibility, weather, road and traffic conditions.

NOTICE

- Remove the cross bars and the roof carrier system before entering a car wash.
- Vehicle height is increased by the installation of cross bars or a roof carrier system and the load secured on them. For this purpose, check that your vehicle's height does not surpass the headspace limit, for example, for underpasses or for entering garage doors.
- Cross bars, the roof carrier system and the load secured on them should not interfere with the roof aerial or hamper the path of the panoramic sun roof and the rear lid.
- On opening the rear lid make sure that it does not knock into the roof load.

For the sake of the environment

When cross bars and a roof carrier system are installed, the increased air resistance means that the vehicle uses more fuel.

Securing the crossbars and the roof carrier system

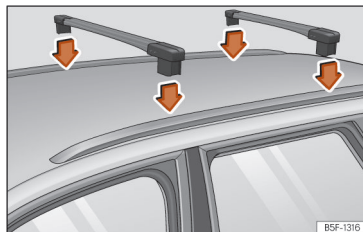


Fig. 201 Mounting points for the roof bars for the roof rack (Leon Sportstourer).

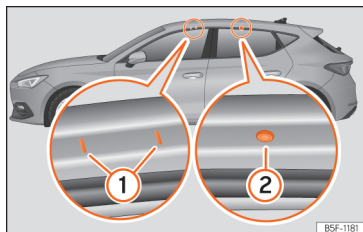


Fig. 202 Mounting points for the roof bars for the roof rack (Leon).

The crossbars are the basis of a series of special roof carrier systems. For safety reasons, special fixtures must be used to safely transport

luggage, bicycles, skis, surf boards or boats on the roof. Suitable accessories can be acquired at SEAT dealerships.

Always secure the crossbars and the roof carrier system properly. Always take the assembly instructions that come with the crossbars and the roof carrier system in question into account.

Installing the bars

Valid for the Leon Sportstourer: The crossbars are assembled on the roof railings »» Fig. 201. The distance between cross bars (A) should be approx. 75 cm and the distance between the front bars and the front bracket of the side roof bar (B) should be 30 cm.

Valid for Leon: The front and rear attachment points (1) and (2) are only visible when the doors are open »» Fig. 202.

WARNING


Incorrect attachment and use of the crossbars and the roof carrier system may cause the whole system to detach from the roof and cause an accident and injuries.

- Always take the manufacturer assembly instructions into account.
- Check threaded joints and attachments travelling and if necessary tighten them after you have travelled a short distance. When making long trips, check the threaded joints whenever you stop for a rest.
- Do not modify or repair the crossbars or roof carrier system.


Note

Always read the assembly instructions that come with the crossbars and the roof carrier system carefully and keep them in the vehicle.

Loading the roof carrier system

The load can only be secured if the crossbars and the roof carrier system are properly installed »» .


Maximum authorised cargo on the roof

The maximum permissible roof load is **50 kg** (Leon) and **75 kg** (Leon Sportstourer). This figure comes from the combined weight of the roof carrier, the cross bars and the load itself on the roof »» .

Always check the weight of the roof carrier system, the cross bars and the weight of the load to be transported and weigh them if necessary. Never exceed the maximum authorised roof load.

If you are using cross bars and a roof carrier with a lower weight rating, you will not be able to carry the maximum authorised roof load. In this case, do not exceed the maximum weight limit for the roof carrier which is listed in the fitting instructions.

Distributing a load

Distribute loads uniformly and secure them correctly »» .

Check attachments

Once the cross bars and roof carrier system have been installed, check the bolted connections and attachments after a short journey and subsequently with a certain frequency.

⚠ WARNING

- Never exceed the maximum authorised load on the roof and on the axles or the vehicle's maximum authorised weight.
- Never exceed the load capacity of the cross bars and the roof carrier system, even if the maximum authorised roof load has not been reached.
- Secure heavy items as far forward as possible and distribute the vehicle load uniformly.

⚠ WARNING

If the load is loose or not secured, it could fall from the roof carrier system or cause accidents and injuries.

- Always use belts or retaining straps that are suitable and in a good condition.

Trailer mode

Introduction

Take into account country-specific regulations about driving with a trailer and the use of a towing bracket.

The vehicle has been developed primarily for carrying people, although it can also be used to tow a trailer if fitted with the corresponding technical equipment. This additional load has

an effect on the useful life, fuel consumption and vehicle performance and in some cases can reduce the service intervals.

Driving with a trailer requires more force from the vehicle, and thus more concentration from the driver.

In winter, winter tyres should be fitted on both the vehicle and the trailer.

Maximum vertical load technically permitted on the coupling device

The *maximum* vertical load technically permitted from the trailer draw bar on the towing bracket's tow ball is **80 kg**.

Vehicles with the Start-Stop system

If the vehicle has a factory-fitted towing bracket or one that is retrofitted by SEAT, the Start-Stop system operates as normal. No special characteristics need to be taken into account.

If the system does not recognise the trailer or the trailer bracket has not been retrofitted by SEAT, the Start-Stop system must be disconnected by pressing the corresponding button in the lower part of the centre console before driving with the trailer, and it should remain off for the rest of the journey >>> ⚠.

Vehicles with driving profile selection

If you are going to be towing a trailer, the use of the **Eco** driving profile is not recommended. You are advised to select another of the available driving profiles before beginning to drive with a trailer.

Trailer weight/drawbar load

Never exceed the authorised trailer weight. If you do not load the trailer up to the maximum permitted trailer weight, you can then climb correspondingly steeper slopes.

The maximum trailer weights listed are only applicable for **altitudes** up to 1000 m above sea level. Since higher altitude decreases engine performance and the ability to climb slopes, the tow load decreases proportionally. The weight of the vehicle and trailer combination must be reduced by 10% for every 1000 m of altitude. When possible, operate the trailer with the maximum **authorised drawbar load** on the ball joint of the towing bracket, but **do not exceed** the specified limit.

⚠ WARNING

Never use the trailer to transport people, since it would put their life in danger and is also prohibited.

⚠ WARNING

Undue use of the towing bracket may cause injury and accidents.

- Only use the towing bracket if it is in a perfect state of repair and is properly secured.
- Never modify or repair the towing bracket in any way.
- In order to reduce the danger of injury in the event of rear-end collisions and to avoid injury to pedestrians and cyclists when parking the vehicle, cover or remove the tow hook when you are not using a trailer.
- According to EU regulation 2021_535 it is not permitted to install a towing device that completely or partially covers the rear number plate.
- Never fit a towing bracket “with weight distribution” or “load compensation”. The vehicle has not been designed for this type of towing bracket. The towing bracket could fail and the trailer could be released from the vehicle.

⚠ WARNING

Driving with a trailer and transporting heavy or large objects can affect driving properties and even cause an accident.

- Always secure the load properly using belts or straps that are suitable and in good condition.
- Adapt your speed and driving style at all times to suit visibility, weather, road and traffic conditions.
- Trailers with a high centre of gravity are more likely to overturn than those with a low one.
- Avoid sudden braking and manoeuvres.
- Take great care when overtaking.
- Reduce speed immediately if you notice that the trailer is swaying, however slightly.
- Never drive at more than 80 km/h (50 mph) when towing a trailer (or at more than 100 km/h (60 mph) in exceptional circumstances). This also applies in countries where driving at higher speeds is permitted. Take into account the speed limit for vehicles with trailers in the corresponding country, as it could be less than the speed limit for vehicles without a trailer.
- Never attempt to “straighten” the towing vehicle and trailer while accelerating.

⚠ WARNING

If the towing bracket has been retrofitted by a non-SEAT workshop, the Start-Stop system must be disconnected manually whenever driving with a trailer. Otherwise the brake system could be damaged and could consequently cause a serious accident or injury.

- Always disconnect the Start-Stop system manually when using a towing bracket that has not been fitted by a SEAT workshop.

i Note

- Before hitching or unhitching a trailer, always deactivate the anti-theft alarm >>> page 96. Otherwise, the tilt sensor could cause the alarm to go off.
- Do not drive with a trailer for the engine's first 1000 km >>> page 150.
- Some retrofitted towing brackets cover the rear towing eye. In these cases, the towing eye should not be used for tow-starting or for towing other vehicles. For this reason, if the vehicle has been retrofitted with a towing bracket, always keep the tow hook in the vehicle when you remove it.

Technical requirements

Vehicles that are **factory**-equipped with a towing bracket fulfil all the technical and legal requirements for driving with a trailer.

If the **vehicle is retrofitted with a tow bracket**, only a bracket that is authorised for the maximum authorised load of the trailer that is to be towed may be fitted. The towing bracket must be suitable for the vehicle and the trailer and must be properly secured to the vehicle's chassis. Only use a towing bracket that has been authorised by SEAT for this vehicle. Always check and take into account the towing bracket manufacturer's instructions.

Towing bracket fitted on the bumper

Never fit a towing bracket to the bumper or to the area where the bumper is mounted. The towing bracket should not impair the bumper's function. Do not make modifications or repairs to the exhaust system or the brake system. Make regular checks to ensure that the towing bracket is secure.

Engine cooling system

Driving with a trailer increases the load on the engine and cooling system. The cooling system should have sufficient coolant and be prepared for the additional effort involved in driving with a trailer.

Trailer brakes

If the trailer has its own brake system, please take the relevant legal requirements into account. Never connect the trailer's brake system to the vehicle's brake system.

Tow cable

Always use a cable between the vehicle and the trailer »» page 296.

Trailer tail lights

The trailer's rear lights should comply with the statutory safety regulations »» page 296.

Never connect the trailer's rear lights directly to the vehicle's electric system. If you are not sure that the trailer's electrical connection is correct, have it checked by a specialised workshop. SEAT recommends visiting a SEAT dealership for this.

Exterior mirrors

If you cannot see the area behind the trailer with the exterior mirrors of the towing vehicle, additional mirrors will have to be installed in accordance with the regulations of the country in question. The exterior mirrors should be adjusted before you start driving and must provide a sufficient field of vision at the rear.

WARNING

If the towing bracket is wrongly fitted or is not the right one, the trailer could become detached from the vehicle and cause serious injury.

NOTICE

- If the rear lights of the trailer are not correctly connected, the vehicle's electronic system may be damaged.
- If the trailer absorbs excessive electric current, the vehicle's electronic system may be damaged.
- Never connect the trailer's electric system directly to the electrical connections of the tail lights or any other power sources. Only use the connections intended for providing electric current to the trailer.

Hitching and connecting a trailer

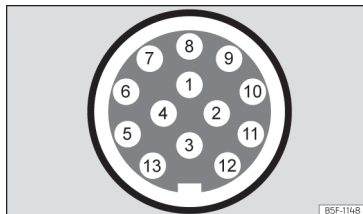


Fig. 203 Diagram: assignment of the pins of the trailer's electrical socket.

Pin	Meaning
1	Left turn signal
2	Rear fog light

Pin	Meaning
3	Earth for pins 1, 2, 4, 5, 6, 7 and 8
4	Right turn signal
5	Rear light, right
6	Brake lights
7	Rear light, left
8	Reverse lights
9	Permanent live
10	Live charge cable
11	Earth for pin 10
12	Unassigned
13	Earth for pin 9

Power socket for trailer

The vehicle is fitted with a 13-pole power socket for the connection between the trailer and the vehicle. With the engine running, electrical devices on the trailer receive power from the electrical connection (pin 9 and pin 10 of the trailer power socket).

If the system detects that a trailer has been connected, the consumers on the trailer will receive electricity through this connection (pins 9 and 10). Pin 9 has a permanent live. This powers, for example, the trailer's interior lighting. Electrical devices such as a fridge in a caravan **only** receive electrical power if the engine is running (through pin 10).

To avoid overloading the electrical system, you cannot connect the ground wires of pin 3, pin 11 or pin 13.

If the trailer has a **7-contact connector**, you will need to use an adapter cable. In this case the function corresponding to pin 10 will not be available.

Tow cable

The tow rope must always be securely fixed to the towing vehicle and loose enough so that the vehicle can handle turns smoothly. However, make sure that the cable does not rub on the ground while driving.

Trailer tail lights

Always check the trailer's rear lights to ensure they are working correctly and that they comply with the relevant safety regulations. If you connect the trailer to the factory-mounted system, when you turn on the rear fog lamp, the fog lamp of the towing vehicle will turn off to turn on the trailer fog lamp.

Include in the anti-theft alarm

The trailer is included in the anti-theft system if the following conditions are met:

- If the vehicle is factory-equipped with an anti-theft alarm.
- If the vehicle is factory-equipped with a tow bracket.

- If the trailer is electrically connected to the towing vehicle through the trailer power socket.

- If the electrical systems of the vehicle and trailer are in perfect condition and have no faults or damage.

- If the vehicle is locked with the key and the anti-theft alarm is activated.

When the vehicle is locked, the alarm is triggered if the electrical connection with the trailer is cut off.

Before hitching or unhitching a trailer, always turn off the anti-theft alarm. Otherwise, the tilt sensor could cause the alarm to go off.

Trailers with LED tail lights

For technical reasons, trailers fitted with LED rear lights cannot be connected to the anti-theft alarm system.

When the vehicle is locked, the alarm does not go off when the electrical connection with the trailer is cut if it has rear lights with light-emitting diodes.

⚠ WARNING

If the cables are improperly or incorrectly connected, it may lead to an excessive amount of current supplied to the trailer, which can cause abnormalities in the entire vehicle electronic system, as well as accidents and serious injuries.

- Ensure that any repairs that need to be carried out on the electrical system are carried out by a specialised workshop.
- Never connect the trailer's electric system directly to the electrical connections of the tail lights or any other power sources.

⚠ WARNING

Contact between the pins of the trailer power socket can cause short circuits, overloading of the electrical system or failure of the lighting system, and consequently can cause accidents and serious injuries.

- Never connect the pins of the trailer power socket to each other.
- Make sure any work on bent pins is carried out by a specialised workshop.

ⓘ NOTICE

Do not leave the trailer connected to the vehicle when parked; place it on its support wheel or its supports. If the vehicle rises or falls due, for example, to a variation of the load or a burst tyre, increased pressure will be placed on the towing bracket and the trailer, and both the vehicle and the trailer can be damaged.

ⓘ Note

- In case of anomalies in the electrical systems of the vehicle or trailer, as well as in the anti-theft alarm system, have them inspected by a specialised workshop.
- If the trailer accessories consume energy through the power socket to the trailer and the engine is turned off, the battery will discharge.
- If the vehicle battery is running low, the electrical connection with the trailer will be automatically cut.

Trailer loading**Technically permissible maximum trailer weight and vertical load on the coupling device**

The technically permissible maximum trailer weight is the weight that the vehicle can tow »» ⚠. The vertical load on the coupling is exerted vertically from above on the hook of the towing bracket.

The information on the maximum trailer weight and vertical load on the coupling device contained in the type plate of the towing bracket are experimental values only. The correct figures for your specific model, which may be lower than these figures, are given in the vehicle documentation. The information in the vehicle documentation takes precedence at all times.

To promote safety while driving, SEAT recommends making the most of the maximum vertical load technically permissible on the coupling device »» page 294. An insufficient vertical load has a negative influence on the behaviour of both the vehicle and trailer.

The vertical load increases the weight on the rear axle, reducing the vehicle's carrying capacity.

Gross combination weight of the towing vehicle and trailer

The gross combination weight is the actual weight of the loaded vehicle plus the actual weight of the loaded trailer.

In some countries trailers are classified into distinct categories. SEAT recommends obtaining information from a specialised workshop regarding which type of trailer is most suitable for your vehicle.

Trailer loading

The weight of the towing vehicle and trailer must be balanced. In order to do this, the load must be as close as possible to the maximum vertical load technically permissible on the coupling point, and it must be evenly distributed between the back and front of the trailer:

- Distribute loads in the trailer so that heavy objects are as near to the axle as possible or above it.
- Secure the trailer load properly.

Tyre pressure

Set the tyre pressure of the trailer tyres in accordance with the trailer manufacturer's recommendations.

When towing a trailer, inflate the tyres of the towing vehicle with the maximum allowable pressure »» page 347.

WARNING

If the maximum permissible axle weight, the maximum load technically permissible on the coupling point, the maximum authorised vehicle weight or the gross combination weight of the towing vehicle and trailer are exceeded, accidents and serious injuries may occur.

- Never exceed the indicated values.
- The actual weight on the front and rear axles must never exceed the maximum permissible axle weight. The weight on the front and rear axles must never exceed the maximum permissible weight.

WARNING

A shift in weight could jeopardize the stability and security of the towing vehicle and trailer, which could lead to accidents and serious injuries.

- Always load the trailer correctly.
- Always secure the load properly using belts or straps that are suitable and in good condition.

Driving with a trailer

Adjusting the headlights

The front part of the vehicle may be raised when the trailer is connected and the light may dazzle the rest of the traffic.


Specific features of driving with a trailer

- If your trailer has an **overrun brake**, brake *gently at first* and then rapidly. This will prevent the jerking that can be caused by the locking of trailer wheels.
- Due to the gross combination weight of the towing vehicle and trailer, the braking distance increases.
- When going down a slope, engage a lower gear (with a manual gearbox, or use the automatic gearbox's tiptronic mode) to use engine braking. Otherwise, the brake system could overheat and even fail.
- The trailer weight, as well as the gross combination weight of the towing vehicle and trailer, change the centre of gravity and the properties of the vehicle.
- If the towing vehicle is empty and the trailer is loaded, then the load distribution is incorrect. Under these conditions, drive slowly and with extra caution.

Hill starts with a trailer


Depending on the slope of the hill and the combination weight of the towing vehicle and trailer, the vehicle might start rolling backwards slightly when you first start up.

For hill starts with a trailer hitched:


- Press and hold the brake pedal.
- Press the  button to disconnect the electronic parking brake »» page 209.

- **Manual gearbox:** Depress the clutch pedal fully and engage 1st gear.

Automatic gearbox: Move the selector lever to the **D/S** position.

- Pull out the  button and hold it in that position to stop the towing vehicle and trailer with the electronic parking brake.
- Release the brake pedal.
- Move off slowly.

Manual transmission: release the clutch pedal slowly.

- Do not release the  button until the engine has sufficient power to start driving.

WARNING

If a trailer is pulled incorrectly, this may lead to loss of control of the vehicle and serious injury.

- Driving with a trailer and transporting heavy or large objects will change the vehicle handling and braking distances.
- Always drive cautiously and carefully. Brake earlier than usual.
- Adapt your speed and driving style at all times to suit visibility, weather, road and traffic conditions. Slow down, especially when driving down hills or slopes.
- Accelerate with particular care and caution. Avoid sudden braking and manoeuvres.

- Take great care when overtaking. Reduce speed immediately if you notice that the trailer is swaying, however slightly.

- Never attempt to "straighten" the towing vehicle and trailer while accelerating.



- Take into account the speed limit for vehicles with a trailer, as it could be lower than for vehicles without a trailer.

Stabilisation of the towing vehicle and trailer combination

The stabilisation of the vehicle and trailer combination is an additional function of the electric stability control (ESC).

If the system detects that the trailer is weaving, it intervenes to reduce the swaying of the trailer.

Vehicle and trailer combination stabilisation requirements

- The vehicle is factory-equipped with a towing bracket or has been retro-fitted with a compatible towing bracket.
- The ESC and TCS are active. The control lamp  or  is not lit up on the instrument cluster.
- The trailer is connected to the towing vehicle through the trailer power socket.
- The vehicle is travelling at over 60 km/h (approx. 37 mph).

- The maximum vertical load technically permissible is not being exceeded on the coupling device.

- The trailer has a rigid draw bar.

- If the trailer has brakes, it must be equipped with a mechanical overrun brake.

WARNING

The enhanced safety provided by the electric stability control of the vehicle and trailer should not lead you to take any risks that could compromise your safety.

- Adapt your speed and driving style at all times to suit visibility, weather, road and traffic conditions.
- Accelerate with caution when the road is slippery.
- When adjusting any settings, stop accelerating.

WARNING

The electric stability control for the vehicle and trailer may not correctly detect all driving conditions.

- When the ESC is switched off, the stabilisation of the towing vehicle and trailer is also switched off.
- The stability system does not always detect light trailers, so it may not stabilise these correctly.

- When driving on surfaces with poor grip, the trailer can even interfere with the stability system.
- Trailers with a high centre of gravity can tip over without having previously weaved.
- If a trailer is not attached, but a connector is plugged into the power socket (e.g. installation of a bicycle rack with lights), repeated automatic braking may occur in extreme driving conditions.

Electrically unlocking trailer hook

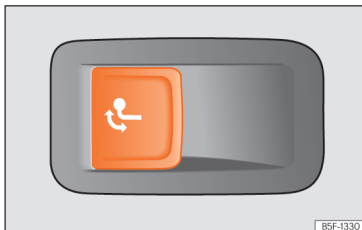


Fig. 204 Left side of the luggage compartment: button to unlock the tow hitch.

The hook of the towing device is located in the bumper and cannot be removed.

There should be no person, animal or object in the path of the tow hook »» » ⚠.

Unlocking the tow hook and removing it

- Stop the vehicle and connect the electronic parking brake »» page 209.
- Switch off the engine.
- Open the rear lid.
- Pull the »» Fig. 204 button briefly. The tow hook unlocks electrically and automatically turns outwards. The button's control lamp flashes.
- Finish remove the tow hook by hand until you feel and hear that it has engaged and the control lamp on the button stays on.
- Close the rear lid.
- Hitching and connecting a trailer »» page 296.

Retracting the tow hook

- Stop the vehicle and apply the electronic parking brake.
- Switch off the engine.
- Unhook the trailer and interrupt the electrical connection between it and the vehicle. If you are using an adapter, remove it from the trailer's power socket.
- Open the rear lid.
- Pull the »» Fig. 204 button briefly. The tow hook unlocks electrically.

- Turn the tow hook under the bumper with your hand until you feel and hear that it engages and the control lamp on the button remains on continuously.
- Close the rear lid.

The button's control lamp

→ Flashing:

This means that the tow hook has not yet engaged correctly or is damaged »» ⚠.

→ Remains on:

If it remains on while the rear lid is open, the tow hook is correctly in place both when extracted and when covered.

The button's indicator lamp switches off approximately 1 minute after closing the rear lid.

⚠ WARNING

Undue use of the towing bracket may cause injury and accidents.

- Only use the tow hook if it is properly engaged.
- Always ensure that no person, animal or object is to be found in the path of the tow hook.
- Never use a tool or instrument while the tow hook is moving.
- Never press the button »» Fig. 204 when there is a trailer hooked to the vehicle or when a carrier system or other accessories are mounted on the tow hook.

- If the tow hook is not attached properly, do not use it. Instead, go to a specialised workshop and have the towing bracket checked.
- If you detect any fault in the electrical system or in the towing bracket, contact a specialised workshop and ask them to check it.
- If the ball has a diameter of less than 49 mm at any one point, do not use the towing bracket under any circumstances.

NOTICE

If you clean the vehicle with high-pressure or steam devices, do not point the jet directly towards the retractable tow hook or the trailer power socket, as this may damage the joints or remove the grease necessary for lubrication.

Note

At extremely low temperatures, the tow hook may be impossible to operate. In this case, place the vehicle in a warmer location (for example, a garage).

Installing a rear carrier system or a bicycle rack on the trailer hitch

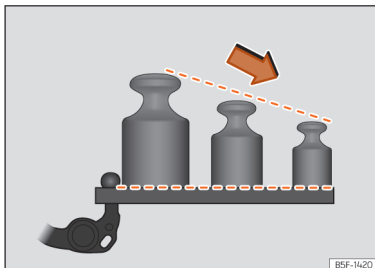


Fig. 205 Recommended weight distribution on the rear support system.

Examples of rear carrier systems are bicycle racks or multi-purpose boxes that are installed on the trailer hitch.

Only use rear carrier systems that have been specified by the respective manufacturer for the vehicle model, model year and version of the vehicle in question » .

SEAT recommends the use of genuine SEAT spare parts and accessories, which can be purchased from the brand's dealers. Install the rear carrier system according to the manufacturer's installation instructions.

The load capacity results from the weight of the rear carrier system and the weight of the load carried on it.

The recommended maximum load capacity of the rear carrier system installed on the trailer hitch may be different from the maximum vertical load on the specific vehicle coupling.

However, it is not permitted to exceed the maximum permitted vertical load on the tow hitch (which depends on the model).

The load capacity is reduced due to the lever effect that occurs the further the carrier system is from the ball head.

Place heavy objects as close as possible to the trailer hitch » **Fig. 205**.

Maximum load capacity depending on the vehicle

To find out the recommended load capacity for your vehicle, check the maximum vertical load on its coupling » **page 381**. Please refer to the following table for the load capacity.

In accordance with the UN-R-55 guideline, SEAT recommends not carrying more bicycles than recommended on the rear rack system.

Maximum vertical load on the vehicle's specific coupling	Maximum load capacity	Number of bicycles
50 kg	50 kg	2
55 kg	55 kg	2
From 75 kg	75 kg	3

Maximum load overhang of the rear carrier system

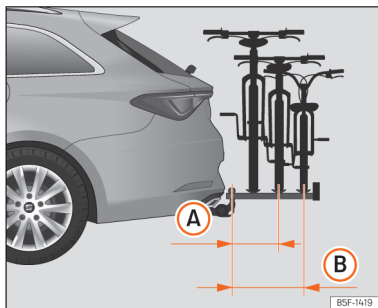


Fig. 206 Schematic representation of the maximum load overhang of a bicycle rack for two or three bicycles.

- A** With up to 55 kg load capacity: 500 mm (approx. 19.7 in)
- B** With 75 kg load capacity: 700 mm (approx. 27.6 in)

The maximum overhang shall not exceed 500 mm from the centre of the ball head to the to the centre of the rail of the last support >>> **Fig. 206 A** for two-bicycle racks. In the case of three-bicycle racks, the overhang must not exceed 700 mm >>> **Fig. 206 B**.

⚠ WARNING

The incorrect use of a rear carrier system installed on the tow hook can cause accidents and injury.

- Make sure that the carrier system is suitable for your vehicle.
- Read and observe the installation instructions of the rear carrier system manufacturer.
- Never attach a rear carrier system below the ball head of the trailer hitch. The system could slip due to the shape of the hitch.

i Note

Before setting off, SEAT recommends removing, to the extent possible, all accessories from the load attached to the carrier system. Examples of these accessories are baskets and panniers, child seats or batteries. This improves the aerodynamics and centre of gravity of the rear carrier system.

Retrofitting a towing bracket

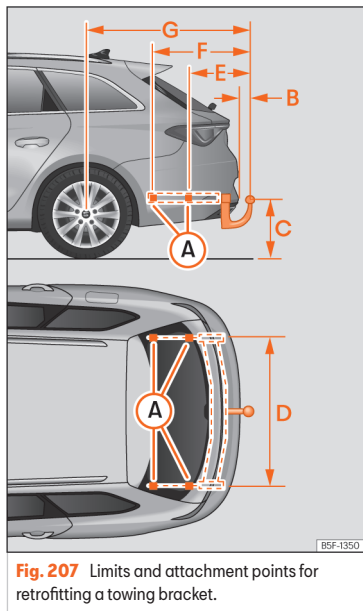


Fig. 207 Limits and attachment points for retrofitting a towing bracket.

Distance measurements (measurements can vary depending on the different chassis combinations):

- A** Mounting points on the vehicle

- Ⓑ 65 mm (minimum)
- Ⓒ 350 mm to 420 mm (fully laden vehicle)
- Ⓓ 1043 mm
- Ⓔ 344 mm / 333 mm (PHEV)
- Ⓕ 564 mm / 553 mm (PHEV)
- Ⓖ 885 mm (Leon) / 874 mm (Leon PHEV) / 1.162.5 mm (Leon Sportstourer) / 1.151.5 mm (Leon Sportstourer PHEV)

SEAT recommends that towing brackets be retrofitted at a specialised workshop. For example, it may very well be necessary to adjust the cooling system or mount thermal protection plates. SEAT recommends visiting a SEAT dealership for this.

If a towing bracket is retrofitted, the distance specifications should always be kept in mind.

The distance between the centre of the ball head and the road »» Fig. 207 Ⓒ must never be less than that indicated. This also applies when the vehicle is fully loaded, including the technically permissible maximum vertical load on the coupling device.

WARNING

If the cables are improperly or incorrectly connected, this may lead to malfunctions in the entire vehicle electronic system, as well as to accidents and serious injuries.

- Never connect the trailer's electric system to the electrical connections of the tail lights or any other unsuitable power sources. Only use suitable connectors to connect the trailer.
- The towing bracket should be retrofitted only at a specialised workshop.

WARNING

If the towing bracket is badly fitted or unsuitable, the trailer may separate from the vehicle while driving. This could cause serious accidents and fatal injuries.

Note

- According to regulation EU2021_535 it is not permitted to install a towing device that cannot be removed or retracted.
- Only use towing brackets that have been approved by SEAT for the model in question.
- In some versions, the fitting of a conventional towing hook solution is not recommended. Please consult your Technical Service.

Fuel and exhaust gas cleaning

Refuelling

Safety warnings regarding fuel handling

WARNING

Fuel is highly flammable and can cause serious burns and other injuries.

- When refuelling, turn off the engine and turn off the ignition for safety reasons.
- The fuel system of PHEV models is pressurized to prevent petrol vapours from escaping into the atmosphere.
- Do not smoke when filling the fuel tank or a canister. Naked flames are forbidden in the vicinity due to the risk of explosion.
- Observe legislation governing the use, storage and carrying of a spare fuel canister in the vehicle.
- For safety reasons we do not recommend carrying a spare fuel canister in the vehicle. In an accident the canister could be damaged and could leak.
- If, in exceptional circumstances, you have to carry a spare fuel canister, please observe the following points:

- Never fill fuel into the spare fuel canister if it is inside or on top of the vehicle. This could cause an explosion. Always place the canister on the ground to fill it.
- Insert the filling nozzle as far as possible into the spare fuel canister.
- If the spare fuel canister is made of metal, the filling nozzle must be in contact with the canister during filling. This helps prevent an electrostatic charge building up.
- Never spill fuel in the vehicle or in the luggage compartment. Fuel vapour is explosive. Risk of fatal accident!

NOTICE

- If any fuel is spilt onto the vehicle, it should be removed immediately. It could otherwise damage the paintwork.
- Never run the tank completely dry. The catalytic converter can be damaged.
- When filling the fuel tank after having run it completely dry on a vehicle with a diesel engine, the ignition must be switched on for at least 30 seconds before starting the engine. When you then start the engine it may take longer than normal (up to one minute) to start firing.

For the sake of the environment

Do not overfill the fuel tank, it may cause the fuel to overflow if it becomes warm.

Note

There is no emergency mechanism for the manual release of the fuel tank flap. If necessary, request assistance from specialised personnel.

Note

Diesel vehicles are fitted with a protective device that prevents the insertion of the wrong fuel hose¹⁾. It is only possible to refuel with Diesel nozzles.

- If the pump nozzle is worn, damaged, or if it is very small, it is possible that it will not be able to open the protective device. Before trying to insert the pump nozzle by turning it, try a different pump or request specialist help.
- If you fill the tank from a reserve fuel canister, the protective device will not open. One way to resolve this is to pour the fuel in very slowly.

¹⁾ Depending upon country.

Refuelling

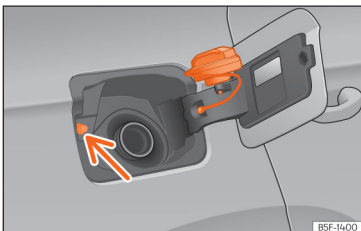



Fig. 208 Fuel tank flap with tank cap attached.

The fuel tank flap is on the rear right of the vehicle.

- The tank flap is unlocked when the car is unlocked using the central locking remote control >>> **page 92**.

Hybrid vehicles: Use the  button on the driver's door to release the tank flap >>> **page 306**.


- Open the fuel tank flap by pressing on the retainer zone.
- Unscrew the cap by turning it to the left.
- Place it in the space on the hinge of the open flap >>> **Fig. 208**.

- Start refuelling. The tank is full as soon as the pump's automatic nozzle cuts off the fuel supply. Do not try to put in more fuel after the nozzle cuts out, as this will fill the expansion chamber in the fuel tank.
- Unscrew the cap by turning it to the right as far as it will go.
- Close the lid.

The correct fuel grade for your vehicle is given on a sticker on the inside of the fuel tank flap. Further notes on fuel can be found at >>> **page 307**.

The capacity of your vehicle's fuel tank is given in >>> **page 381**.

Hybrid vehicles



Every 6 months it is necessary to run on petrol until the control lamp switches off  and then the tank must be refilled. This is necessary to ensure that the system works properly, as well as the fuel quality required for driving with petrol.

Purging the fuel tank


✓ Valid for: hybrid vehicles.




Fig. 209 Driver's door: tank cover release.

Before refuelling the fuel system must be depressurised >>>  in **Safety warnings regarding fuel handling on page 305**. To do this, press the  button on the driver's door.

An audible sound will be played and a warning will be displayed on the instrument cluster display.

After a few seconds the fuel tank flap will unlock and remain unlocked for a few minutes. If you have not refuelled after this time, you must press the  button again before refuelling.

Avoid touching the fuel tank flap lock button >>> **Fig. 208** (arrow). The system will interpret that you have finished and cannot continue refuelling. Press the  button on the driver's door again to continue.

Fuel types

Identification of fuels¹⁾

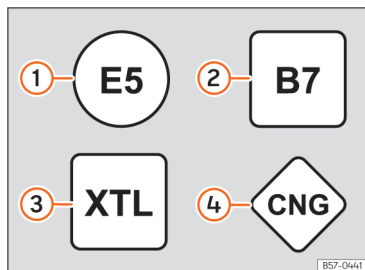


Fig. 210 Identification of fuels according to European Union (EU) Directive 2014/94/

Fuels are identified by different **symbols on the pump and on your vehicle's tank flap**. The identification serves to prevent confusion when choosing the fuel.

- 1) **Petrol** with ethanol ["E" stands for **E**thanol]. The number indicates the percentage of ethanol in the petrol: "E5" means an ethanol ratio of 5% max. "E10" means an ethanol ratio of 10% max. "E20" means an ethanol ratio of 20% max.

- 2) **Diesel** according to EN590 standard. The number indicates the maximum percentage of Biodiesel in the fuel. "B7" means a maximum of 7% Biodiesel.
- 3) Synthetic **diesel** according to EN15940 standard.
- 4) **Natural gas**: "CNG" means **C**ompressed **N**atural **G**as

Type of petrol

The correct grade of petrol is listed inside the fuel tank flap.

The vehicle is equipped with a catalytic converter and must only be run on **unleaded petrol**. The petrol must comply with the standard EN 228 and be **sulphur-free**. Follow the regulations of the country you are driving in. The types of petrol are differentiated by using the **octane numbers (RON)** or via the **anti-knock index (AKI)**.

Super unleaded petrol 95 octane petrol or normal 91 octane petrol at least

We recommend refuelling with super 95 octane petrol (91 AKI). If not available, normal 91 octane petrol (87 AKI) (with a slight power loss) may be used.

Super unleaded petrol, 95 octanes at least

You should use super 95 octane petrol (91 AKI) at least.

If super petrol is not available, if necessary, use normal 91 octane petrol (87 AKI). In this case only use moderate engine speeds and a light throttle. Refuel with super as soon as possible.

Unleaded super plus 98 octane petrol or super 95 octane petrol at least

We recommend refuelling with super plus 98 octane petrol (93 AKI). If not available: super 95 octane petrol (91 AKI) (with a slight power loss).

If super petrol is not available, if necessary, use normal 91 octane petrol (87 AKI). In this case only use moderate engine speeds and a light throttle. Refuel with super as soon as possible.

! NOTICE

- **Fuels with a high percentage of ethanol, e.g. E30 - E100 button must not be used. The fuel system would be damaged.**
- **A single refuelling with leaded fuel or other metal additives entails a permanent deterioration of the effectiveness of the catalytic converter.**
- **Only use fuel additives that have been approved by SEAT. The products that contain substances to increase the octane rating or**

¹⁾ Depending upon country.

decrease knocking may contain metal additives that damage the engine and catalytic converter. This type of products must not be used.

- Do not use fuels shown in the pump as containing metals. LRP (lead replacement petrol) fuels contain high concentrations of metal additives. Risk of engine damage!
- High engine speed and full throttle can damage the engine when using petrol with an octane rating lower than the correct grade for the engine.

Note

- Fuel with an octane rating higher than the one required by the engine can be used.
- In countries in which there is no sulphur-free fuel, it is also allowed to use low sulphur content fuel.

Ethanol fuel

✓ Valid for: vehicles with Totalflex engines

You can recognise vehicles with Totalflex engines¹⁾ by label on the fuel tank lid with the marking "Petrol/ethanol".

¹⁾ This motor is only available in some markets.

²⁾ Depending upon country.

Vehicles with Totalflex engine can run with unleaded petrol (95 octane / 91 AKI) according to ANP No. 57 and with fuels with any high percentage of ethanol. The vehicle is refuelled in the same way as petrol refuelling.

Also consider that »» page 307, *Type of petrol*.

Note

SEAT recommends filling the tank exclusively with petrol every 10,000 km to decrease impurities that using E100 ethanol fuel might have left in the engine.

Diesel

✓ Valid for: vehicles with diesel engines

Please note the information on the inside of the fuel tank flap.

The diesel can thicken at very low temperatures, thus affecting the start or operation of the engine. Ask your service station attendant if their diesel is suitable for winter use.

Water in the fuel filter²⁾

If your vehicle has a diesel engine and is equipped with a **fuel filter with a water separator**, the instrument panel may display the following warning:

Water in the fuel filter.

If this is the case, take the vehicle to a specialised workshop so that they can drain the fuel filter.

NOTICE

- Never use of FAME (biodiesel that does not meet the EN590 standard), petrol, heating oil, other fuels or thinning agents as they can cause severely damage the fuel system and the engine.
- If the wrong fuel has been filled, do not start the engine under any circumstances. Risk of damaging the fuel system and the engine! Seek professional assistance.


AdBlue®


Information about AdBlue®

AdBlue® consumption depends on your personal driving style, the temperature of the system and the outdoor temperature when the vehicle is used.

AdBlue® freezes at temperatures of -11 °C [+13°F]. The system has heating elements that guarantee its operation even at low temperatures.

When the **range is less than 2,000 or 2,400 km (1,200 or 1,500 miles)**, depending on the version, a message appears on the instrument panel display requesting AdBlue refuelling®.

If this message is ignored, the yellow warning lamp  will come on when the **remaining range is less than 1000 km**. The indication that in XXX km (XXX miles) it will no longer be possible to restart the engine will appear on the instrument cluster display.

If the yellow indicator lamp is ignored, when a **remaining range of 0 km (0 miles)** is displayed, it will no longer be possible to restart the engine. The red warning lamp will light up .

AdBlue® is a registered trademark of the German Association of the Automotive Industry (VDA) and is also known as AUS32 or DEF (Diesel Exhaust Fluid).

NOTICE

Overfilling with AdBlue® can cause damage to the tank system.

Fill AdBlue®

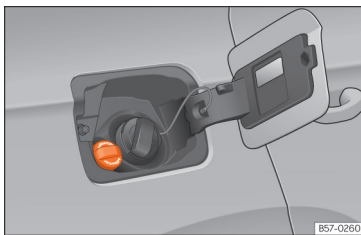


Fig. 211 AdBlue tank cap®.

Operations prior to refilling

Park the vehicle on a flat surface and turn off the ignition. If the vehicle is on a slope or on a curb, the level indicator may not detect the refill properly.

If an AdBlue® warning message is shown on the instrument cluster display, **fill with at least the minimum required amount (approx. 5 litres)**. Only after adding this amount will the system detect that AdBlue® has been added and you will be able to start the engine again.

Fill with a refill bottle

Only use AdBlue® that complies with the ISO 22241-1 standard.

- Only use original containers.
- Open the tank cover >>> **Fig. 211.**

- Unscrew the tank cap by turning it in an anti-clockwise direction.
- Please observe the manufacturer's instructions, indicated on the refill bottle.
- Check the expiry date.
- Remove the cap of the refill bottle.
- Insert the neck of the bottle in the tank filler neck vertically and screw the bottle on by hand, by turning it in a clockwise direction.
- Press the refill bottle in the direction of the filler neck and hold it in this position.
- Wait until the contents of the refill bottle have been poured into the AdBlue® tank. Do not compress or break the bottle!
- Turn the bottle in a counter-clockwise direction and gently pull it upwards >>> **page 310.**
- The AdBlue® tank is full when no more liquid comes out of the bottle.
- Screw on the tank cap in a clockwise direction until it is tightly closed.
- Close the fuel tank flap.

Refilling AdBlue® at the dispenser

Valid for vehicles with selective catalytic reduction.

- Open the tank cap.
- Turn the SCR tank cap anti-clockwise >>> **Fig. 211.**

- Fill with AdBlue® until the nozzle stops for the first time.
- Close the SCR tube by turning it clockwise until you hear a click.

Operations before driving

- After refilling the tank, only switch on the ignition.
- Leave the ignition on for at least 30 seconds for the system to detect the fluid load.
- Make sure you wait for at least 30 seconds before starting the engine!

⚠ WARNING

AdBlue® should only be stored in its original container, which should be tightly closed and kept in a safe place.

ⓘ NOTICE

- When refilling, the nozzle grip should be aligned downward. Otherwise the nozzle will not connect automatically.
- Do not try to add any more additive after the nozzle has stopped for the first time. The AdBlue® tank could overflow and AdBlue® could spill out.
- Only use AdBlue® that complies with the ISO 22241-1 standard. Only use original containers.

- Never mix AdBlue® with water, fuel or additives. Any type of damage caused by such a mixture will not be covered by the warranty.
- Never pour AdBlue® into the fuel tank! This could result in engine damage.
- Do not carry the refill bottle inside the vehicle. If there is a leak (due to temperature changes or damage to the bottle), the AdBlue® may damage the vehicle's interior.

♻ For the sake of the environment

Dispose of the refill bottle in an environment-friendly manner.

ⓘ Note

Suitable AdBlue® refill bottles can be purchased from SEAT dealerships.

Troubleshooting

🔧 AdBlue® level too low

The indicator lamp lights up red. **The engine cannot be restarted!**

Stop the vehicle in a suitable, safe and flat area then top up with the minimum required quantity of AdBlue® >>> page 309.

🔧 together with 🔑: Fault in the AdBlue system®

The indicator lamps light up red. **The engine cannot be restarted!**

Go to a specialised workshop and get the system checked.

🔧 The AdBlue® reserve is low

The indicator lamp lights up yellow.

To top AdBlue® within the number of kilometres (or miles) that are indicated >>> page 309.

🔧 together with 🔑: Fault in the AdBlue® system.

The control lamps light up yellow. There is a fault in the AdBlue® system or non-conforming AdBlue® fluid has been added. Go to a specialised workshop and get the system checked.

Engine management and emissions control system

Introduction

⚠ WARNING

Due to the high temperatures reached by the exhaust gas scrubbing system, you should not park your vehicle near a surface that can catch fire easily. Fire hazard!


WARNING

Do not apply wax underneath the vehicle around the area of the exhaust system: Fire hazard!

Catalytic converter

To maintain the useful life of the catalytic converter

- Only use unleaded petrol with petrol engines.
- Never run the fuel tank dry.
- When changing or adding engine oil, do not exceed the necessary amount >>> **page 335, Checking and topping up the engine oil level.**
- Never tow the vehicle to start it, use jump leads if necessary >>> **page 315.**

If you should notice misfiring, uneven running or loss of power when the car is moving, have the vehicle inspected by a specialised workshop. In general, the emissions warning lamp  will light up when any of these symptoms occur. If this happens, any unburnt fuel can enter the exhaust system and escape into the atmosphere. The catalytic converter can also be damaged by overheating.

NOTICE

Never run the fuel tank completely dry because an irregular fuel supply can cause ignition faults. This allows unburnt fuel to enter the exhaust system, which could cause overheating and damage the catalytic converter.


For the sake of the environment

Even when the emission control system is working perfectly, there may be a smell of sulphur from the gases on occasions. This depends on the sulphur content of the fuel used. This can quite often be avoided by changing to another brand of fuel.

Particulate filter

Valid for: vehicles with petrol or diesel particulate filters

The particulate filter eliminates most of the soot from the exhaust gas system. Under normal driving conditions the filter cleans itself. If the filter does not clean itself (e.g. if short journeys are made continuously), it becomes blocked with soot and the following indication is displayed to the driver:

 **Particulate filter: cleaned while the vehicle is moving. See Manual.**

The particulate filter needs cleaning (regeneration).

Regeneration of the petrol and diesel particulate filter¹⁾

Requirements for the regeneration journey: the engine is at operating temperature.

- Drive at a speed of between 50/20 km/h (31-75 mph). This increases the temperature and burns the soot in the filter >>> **page 312.**
- Consider the legal speed limits as well as the recommended gears.
- End the regeneration journey once the control warning lamp has gone out.

If the warning lamp stays on after 30 minutes of running in regeneration mode, have a specialised workshop repair the fault.

Regeneration of the particulate filter (only for 2.0l and 2.5l TSI engines)

Requirements for the regeneration journey: the engine is at operating temperature.

- Drive at a speed of at least 80 km/h >>> **page 312.**
- Completely remove your foot from the accelerator pedal for a few seconds to let the vehicle roll with the gear engaged.

¹⁾ Except 2.0l and 2.5l TSI petrol engines.

- Consider the legal speed limits as well as the recommended gears.

- Repeat this procedure (accelerate and let roll) until the control lamp turns off.


This procedure involves an autonomous particulate filter cleaning process and may take some time.

If the warning lamp **does not turn off**, go immediately to a specialised workshop to repair the fault.

WARNING

Always adjust your speed to suit the weather conditions, roads, braking distance and traffic if the particulate filter is in its regeneration phase. Route recommendations should never make you disregard each country's specific traffic regulations.

Note

If during the particulate filter regeneration process you also get a fuel reserve warning , the process may be interrupted. Refuel and continue with the particulate filter regeneration process.

NOTICE

- When the exhaust system detects that the particulate filter is close to saturation, the self-cleaning function of this system recommends optimal driving for this function.
- Due to the high temperatures caused by the regeneration of the particulate filter, it is possible that the radiator fan will activate after stopping the engine, even if its operating temperature has not been reached.
- Noise, smells and high idle speeds can occur during regeneration.
- Always use the correct engine oil and the correct fuel to make sure the useful life of the particulate filter is not affected. Also avoid making short trips all the time.

Troubleshooting

Fault in the emission control system.

The indicator lamp lights up yellow.

Reduce speed and drive carefully to the nearest specialised workshop to have the engine checked.

Combustion failures that can damage the catalytic converter.

The control lamp flashes yellow.

Reduce speed and drive carefully to the nearest specialised workshop to have the engine checked.

Particulate filter blocked

The indicator lamp lights up yellow
>>> page 311..

EPC Fault in the petrol engine management.

The indicator lamp lights up yellow.

Have the engine checked as soon as possible by a specialised workshop.

When the ignition is switched on, the **EPC** (Electronic Power Control) lamp lights up and should go off once the engine has started.

Diesel engine preheating system

The indicator lamp lights up yellow.




The engine can be started straight away when the lamp switches off.

Fault in the diesel engine management

The control lamp flashes yellow.

Have the engine checked as soon as possible by a specialised workshop.

NOTICE

While the indicator lamps , , **EPC** or  are on, there might be faults in the engine, fuel consumption may go up and the engine might lose power.

Miscellaneous situations

Vehicle tool kit

On-board toolkit

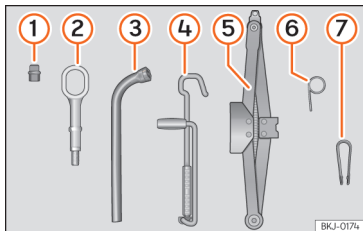


Fig. 212 Underneath the floor panel of the luggage compartment: on-board tools.

The vehicle tool kit is located under the floor panel in the luggage compartment. To access the on-board tools »» page 286.

The tool kit includes:

- ① Adapter for the anti-theft bolt
- ② Towing eye, removable
- ③ Wheel spanner
- ④ Crank handle for jack
- ⑤ Jack

- ⑥ Hook for extracting the central wheel trims
- ⑦ Clip for removing the wheel bolt caps

Some of the items listed are only provided in certain model versions, or are optional extras.

⚠ WARNING

When the vehicle tool kit, tyre mobility set and spare wheel are loose in the interior they can be violently thrown in case of a sudden manoeuvre or braking and especially in accidents, causing serious injury.

- Ensure that the vehicle tool kit, the tyre mobility set and the spare wheel or temporary spare wheel are safely secured in the luggage compartment.

⚠ WARNING

Unsuitable or damaged vehicle tools can cause injury or accidents.

- Never work with inappropriate or damaged tools.

i Note

The jack does not generally require any maintenance. If required, it should be greased using universal type grease.

Changing the windscreen wiper blades

Wiper service position

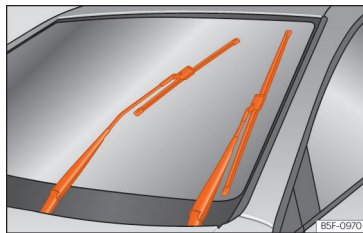


Fig. 213 Wipers in service position.

Ensure that the wiper blades are not frozen.

With the wiper in service position, it is possible to fold the wiper arms »» **Fig. 213**.

- Close the bonnet »» page 325.
- Switch the ignition on and off.
- Briefly press the wiper lever downwards.

Before driving, always lower the wiper arms. Using the windscreen wiper lever, the windscreen wiper arms return to their initial position.

 Note

- The wiper arms can be moved into the re-
placement position when the front bonnet is
fully closed.
- You can also use the service position, for
example, if you want to fix a cover over the
windscreen in the winter to keep it clear of
ice.

Changing the wiper rear wiper blades

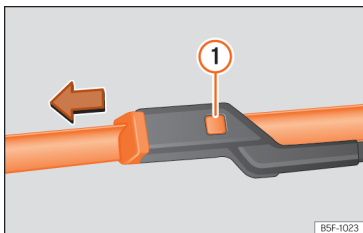


Fig. 214 Changing the windscreen wiper blades

The windscreen wiper blades are supplied as standard with a layer of graphite. This layer is responsible for ensuring that the wipe is silent. If the graphite layer is damaged, the noise of the water as it is wiped across the windscreen will be louder.

Check the condition of the wiper blades regularly. **If the wipers scrape across the glass**, they should be changed if they are damaged, or cleaned if they are dirty >>> ①.

If this does not produce the desired results, the setting angle of the windscreen wiper arms might be incorrect. They should be checked by a specialised workshop and corrected if necessary.

Damaged windscreen wiper blades should be replaced immediately. These are available from qualified workshops.

Raising and lowering windscreen wiper arms

- Place the windscreen wipers in the service position >>> **page 313**.
- Grip the wiper arms **only** by the blade's fastening point.

Cleaning windscreen wiper blades

- Raise the wiper arms.
- Use a soft cloth to remove dust and dirt from the windscreen wiper blades.
- If the blades are very dirty, a sponge or damp cloth may be used >>> ①.

Changing the windscreen wiper blades

- Lift and unfold the wiper arms.
- Press and hold release button >>> **Fig. 214 ①** and pull gently on the wiper blade in the direction of the arrow.

- Fit a new wiper blade of the **same length and design** on to the wiper arm and hook it into place.
- Rest the wiper arms back onto the windscreen.

Changing the rear window wiper blade

- Separate the wiper arm from the rear window.
- Remove the blade from the holder below the centre. During this operation, hold the wiper arm firmly.
- Fit the new blade (of the same length and type) into the housing of the wiper arm by pressing it in place. When doing so, hold the wiper arm by the upper end.
- Fold the wiper arm and rest it on the window.

 **WARNING**

Worn or dirty windscreen wiper blades reduce visibility and increase the risk of accident and serious injury.

- **Always replace damaged or worn windscreen wiper blades or blades that no longer clean the windscreen properly.**

NOTICE

- Damaged or dirty windscreen wipers could scratch the glass.
- If products containing solvents, rough sponges or sharp objects are used to clean the blades, the graphite layer will be damaged.
- Never use fuel, nail varnish remover, paint thinner or similar products to clean the windows.
- In icy conditions, always check that the wiper blades are not frozen to the glass before using the wipers. In cold weather, it may help to leave the vehicle parked with the wipers in service position >>> page 313.

NOTICE

- To prevent damage to the bonnet and the wiper arms, only leave them in the service position.
- Before driving, always lower the wiper arms.

Jump start

Introduction

If the engine fails to start because of a discharged 12-volt battery, the battery can be connected to the battery of another vehicle to start the engine.

Jump leads complying with the **DIN 72553 standard** are needed for starting (see cable manufacturer's instructions). The wire cross section must be at least 25 mm² for petrol engines and at least 35 mm² for diesel engines.

NOTICE

To avoid considerable damage to the vehicle electrical system, note the following carefully:

- If the jump leads are connected incorrectly, a short circuit may occur.
- Use only jump leads with fully insulated clamps.
- Do not allow the vehicles to come into contact with each other, otherwise current may start to flow as soon as the positive poles are connected.

Jump start: description

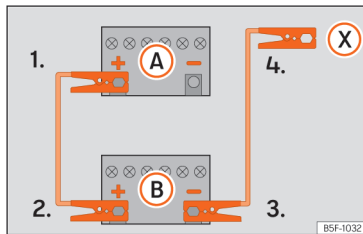


Fig. 215 Wiring diagram for vehicles without a start/stop system.

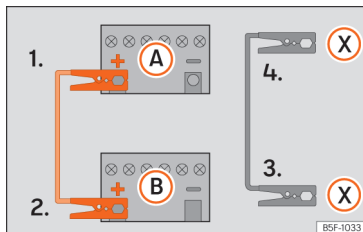


Fig. 216 Wiring diagram for vehicles with a start/stop system.

The discharged battery must be properly connected to the on-board network.

Make sure that the clamps have sufficient metal contact when connecting them to the poles.

Jump lead terminal connections

The jump leads should only be connected in the order **1 > 2 > 3 > 4** »» Fig. 216.

- Switch off the ignition of both vehicles »» **A**.
- Connect one end of the *red* jump lead to the positive (+) terminal of the vehicle with the flat battery **A**.
- Connect the other end of the *red* jump lead to the positive terminal (+) in the vehicle providing assistance **B**.
- Vehicles without a Start-Stop system:* connect one end of the black jump lead to the negative terminal (-) of the vehicle providing the current **B** »» Fig. 215. *Vehicles with a Start-stop system:* connect one end of the black jump lead (X) to a suitable ground terminal, to a solid piece of metal in the engine block, or to the engine block itself »» Fig. 216.
- Connect the other end of the *black* jump lead (X) to a solid metal component bolted to the engine block or to the engine block itself of the vehicle with the flat battery. Do not connect it to a point near the battery **A**.
- Position the leads in such a way that they cannot come into contact with any rotating part in the engine compartment.

Starting

- Start the engine of the vehicle supplying the current and leave it running at idle.
- Start the engine of the vehicle with a discharged battery and wait 2 to 3 minutes until the engine runs.

Disconnecting the jump leads

- Before disconnecting the jump leads, switch off the dipped beam headlight if it is on.
- Turn on the heating fan and the vehicle's heated rear window when the battery is discharged to reduce the voltage peaks that occur while disconnecting the battery.
- While the engines are still running, disconnect the cables in the reverse order in which they were connected.

If the engine does not start after 10 seconds, wait for approximately 1 minute and then try again.

⚠ WARNING

- Please note the safety warnings referring to working in the engine compartment »» page 325.
- The battery supplying the current must have the same voltage (12V) as the flat battery. Failure to comply could result in an explosion.

- Never use jump leads when one of the batteries is frozen. Danger of explosion! Even once thawed, electrolyte leaks can cause burns. Replace the battery if it is frozen.
- Keep any sources of ignition (flames, cigarettes, etc.) far enough away from the batteries. They may cause an explosion.
- Observe the usage instructions of the jump lead manufacturer.
- On the other vehicle, do not connect the negative cable directly to the negative terminal of the discharged battery. Any sparks could ignite the igniter gas coming out of the battery and could cause an explosion.
- The negative wire must never be connected to fuel system components or brake lines on the other vehicle.
- Do not touch uninsulated parts of the pole clamps. The jump lead attached to the positive battery terminal must not touch metal parts of the vehicle, this can cause a short circuit.
- Jump leads must be placed in such a way that they cannot be caught by rotating parts in the engine compartment.
- Do not rest your body on the batteries, as this could cause burns.
- Take into account the instruction manual of the jump lead manufacturer and the instruction manual of the other vehicle.

NOTICE

Immediately go to a specialist workshop and have the 12 volt battery checked.

Towing the vehicle

Introduction

It takes practice to tow a vehicle, especially when using a tow cable. Both drivers should be well informed of the special features of towing. Inexperienced drivers should refrain from towing.

During towing, make sure at all times that no inadmissible traction forces or jolts are generated. On roads without a firm surface there is always the danger of overloading the attachment parts.

Take into account the legal provisions regarding tow starting and towing.

Tow start

Tow starting means starting a vehicle's engine while another puts it in motion by pulling it.

The vehicle can be towed with a tow bar or cable

Towing

Towing means a vehicle pulling another vehicle that is not in a condition to run.

The vehicle can be towed with a tow bar or cable.

- The maximum permitted speed is 50 km/h (30 mph).
- The maximum permitted distance is 50 km (30 miles).

Tow cable and tow bar

It is safer for the vehicle to be towed using a tow bar, avoiding damage to the vehicle. The tow cable should only be used if a tow bar is not available.

A tow rope should be slightly elastic to avoid damage to both vehicles. It is advisable to use a tow rope made of synthetic fibre or similarly elastic material.

Tow with a tow truck

If a breakdown lorry is used, vehicles with automatic transmission are only allowed to be towed with the front wheels suspended.

Towing vehicles with four-wheel drive (4Drive)

Four-wheel drive vehicles (4Drive) can be towed using a tow bar or tow rope. If the vehicle is towed with the front or rear axle suspended, the engine must be switched off, otherwise the transmission may be damaged.

WARNING

During the towing of a vehicle, the driving behaviour and braking capacity change considerably.

WARNING

Never allow the vehicle to be towed if it has no power.

- When towing, never remove the key from the ignition or disconnect the ignition with the ignition and start button. Otherwise, the electronic lock of the steering column could suddenly get blocked and it would be impossible to steer the vehicle. This could cause an accident, serious injury and loss of control of the vehicle.
- If the vehicle runs out of power during towing, stop the process immediately and seek the assistance of specialised personnel.

NOTICE

Towing the vehicle with a tow cable or a tow bar can cause damage to the vehicle.

- If the vehicle is towed with a tow cable or tow bar, special care must be taken.
- If possible, have the vehicle transported on a tow truck.

NOTICE

If the vehicle is pushed by hand, the tail light units, the side spoilers of the rear window and large sheet metal surfaces may be damaged. In addition, the rear spoiler could be detached.

- If the vehicle is pushed by hand, the tail light units, the side spoilers of the rear window, large sheet metal surfaces or the rear spoiler.

NOTICE

Removing and attaching the cover and the towing eye may cause damage to the vehicle, for example, on the paintwork.

- To avoid damaging the vehicle, remove and replace the cover and the towing eye carefully.

NOTICE

Using a towing eye that is not suitable for the vehicle can damage it.

- When towing, always use the vehicle's towing eye, which forms part of the on-board tools, or an appropriate eye for towing.

Instructions for tow-starting and towing

During towing, the change of direction can be signalled on the towed vehicle even when the hazard warning lights are on. To do so, at the same time, the turn signal lever must be operated with ignition switched on. During this time the hazard warning lights remain disconnected. When the turn signal lever is returned to the rest position, the hazard warning lights will be automatically reactivated.

Cases where tow starting and towing the vehicle are not permitted

Do not allow the vehicle to be towed in the following situations:

- The vehicle's gearbox is damaged or has no lubricant.
- The 12-volt battery is discharged. In vehicles with the "Keyless Access" locking and ignition system the steering remains locked and the parking brake cannot be deactivated and the steering column lock cannot be released if they are connected.
- If a distance above 50 km needs to be travelled.
- There is no guarantee that the wheels will turn smoothly or that the steering will work after an accident.

If the vehicle cannot be towed on its wheels for any of the reasons mentioned above, request assistance from specialised personnel and, if necessary, have the vehicle transported without the wheels touching the ground.

Tow start**Steps to be taken prior to tow starting**

Vehicles with an automatic gearbox: Due to technical reasons, tow starting the vehicle is not allowed. Attempt to start the engine using the starting aid »» page 315.

Vehicles with a manual gearbox: In general, it is not recommended to tow start the vehicle. If the engine does not start, try the starting aid first »» page 315. Please note that, in the case of petrol engines, the maximum permitted distance for tow starting is 50 m.


- Secure the tow cable or tow bar using only the attachment points provided for this purpose.
- Switch on the ignition and the hazard warning lights.
- Engage 2nd or 3rd gear while the vehicle is stopped.
- Press the clutch and hold it down.
- When both vehicles are in motion, release the clutch pedal.
- As soon as the engine starts, depress the clutch and disengage the gear to avoid colliding with the towing vehicle.

NOTICE

When tow-starting, unburnt fuel could enter the catalytic converter and damage it.

Towing

Previous steps

- Secure the tow cable or tow bar using only the attachment points provided for this purpose >>> . Depending on the equipment, these points may be a towing device or a towing eye.
- Make sure the tow cable is not twisted. Otherwise the towing eye could unscrew during towing.
- Switch on the ignition and the hazard warning lights of both vehicles. If necessary, take into account other different provisions that may exist in this regard.
- Take into account the instructions on towing provided in the instruction manual of the other vehicle.

Towing vehicle {front}

- Do not actually start driving until the cable is tight.
- Accelerate with particular care.
- Avoid sharp braking and sudden manoeuvres.

Vehicles with a manual gearbox:

- When starting to drive, use the clutch very gently.

Towed vehicle {behind}

- Make sure the ignition is switched on so that the steering wheel does not lock and so that, if necessary, you can use the turn signals and the windscreen wiper.
- The brake servo and power steering only work when the engine is running. Otherwise, you will have to depress the brake pedal considerably harder and more force will be needed to turn the steering wheel.
- Release the electronic parking brake.
- Make sure the tow cable is always taut.
- Disengage the gear or place the gear selector in the **N** position.

WARNING

Never attach the tow rope or tow bar to axle or running gear components. They could be damaged, resulting in an accident and serious injury.

- Seek specialist assistance and, if applicable, have the vehicle transported on a tow truck.

NOTICE

The vehicle can only be towed if the state of charge of the 12-volt battery is sufficient to disengage the electronic parking brake and the steering column lock. If the vehicle has no power supply or there is an electric system fault, the engine must be jump-started to release the electronic parking brake and deactivate the electronic lock of the steering column.

Front towline anchorage



Fig. 217 Front bumper on right: remove the lid.

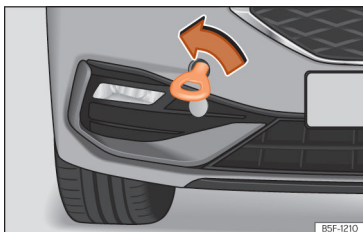


Fig. 218 Right side of the front bumper: towline anchorage screwed in.

The housing of the removable towline anchorage is on the right side of the front bumper underneath a cover >>> **Fig. 217**.

The towing eye should always be kept in the vehicle.

Bear in mind the instructions for towing >>> **page 318**.

Fitting the towline anchorage

- Remove the towing eye from the vehicle tool kit in the luggage compartment >>> **page 313**.
- Remove the cover by pressing down on its base and leave it hanging from the vehicle >>> **Fig. 217**.
- Screw the towing eye in the housing by turning it to the maximum **anticlockwise** >>> **Fig. 218**, >>> ⓪. Use a suitable object that can completely and securely tighten the towing eye in its housing.

- After towing, unscrew the towing eye **clockwise** with a suitable object.
- Replace the cover and push it in until it clicks into place.
- Clean the towing eye if necessary and then store it in the luggage compartment along with the other vehicle tools.

ⓘ NOTICE

The towing eye must always be completely and firmly tightened. Otherwise, it could jump out of the housing during towing.

Rear towline anchorage

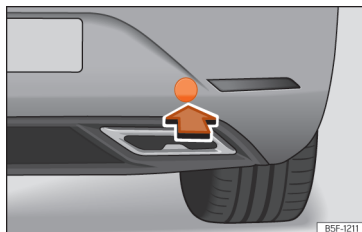


Fig. 219 Rear bumper on right: remove the lid.

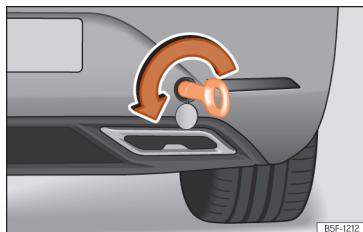


Fig. 220 Right side of the rear bumper: towline anchorage screwed in.

The housing of the screw towing eye is on the right side of the rear bumper behind a lid >>> **Fig. 219**.

Vehicles fitted as standard with a towing bracket **do not** have any housing for the screw towing eye behind the lid. In this case, the tow hitch needs to be extracted or installed and used for towing >>> **page 294**, >>> ⓪.

Bear in mind the instructions for towing >>> **page 318**.

Assemble the rear towing eye (cars without a factory-equipped towing bracket)

- Remove the towing eye from the vehicle tool kit in the luggage compartment >>> **page 313**.
- Press the lower side of the lid >>> **Fig. 219** to unclip it.
- Remove the lid and let it hang from the vehicle.

- Screw the towing eye in the housing by turning it to the maximum **anticlockwise** >>> **Fig. 220** , >>> ①. Use a suitable object that can completely and securely tighten the towing eye in its housing.
- After towing, unscrew the towing eye **clockwise** with a suitable object.
- Replace the cover and press until the tab snaps into the bumper.
- Clean the towing eye if necessary and then store it in the luggage compartment along with the other vehicle tools.

① NOTICE

- The towing eye must always be completely and firmly tightened. Otherwise, it could be released while towing and tow-starting.
- If the vehicle is factory-equipped with a towing bracket, it is only allowed to tow with a tow bar if this has been specially designed to be installed with a tow hitch. If an unsuitable tow bar is used, both the tow hitch and the vehicle may be damaged. Instead, a tow rope should be used.

Fuses

Introduction

In general, a fuse can be assigned to various electrical components. Likewise, an electrical component can be protected by several fuses.

Only replace fuses when the cause of the problem has been solved. If a newly inserted fuse blows after a short time, you must have the electrical system checked by a specialised workshop as soon as possible.

⚠ WARNING

The high voltages in the electrical system can give serious electrical shocks, causing burns and even death!

- Never touch the electrical wiring of the ignition system.
- Take care not to cause short circuits in the electrical system.

⚠ WARNING

Using unsuitable fuses, repairing fuses or bridging a current circuit without fuses can cause a fire and serious injury.

- Never use a fuse with a higher value. Only replace fuses with a fuse of the same amperage (same colour and markings) and size.
- Never replace a fuse by a metal strip, staple or similar.

ⓘ NOTICE

- To prevent damage to the vehicle's electrical system, before replacing a fuse always turn off the ignition, the lights and all electrical elements.
- Protect the fuse boxes when open to prevent the entry of dust or humidity as they can damage the electrical system.

ⓘ Note

In the vehicle, there are more fuses than those indicated in this chapter. These should only be replaced by a specialist workshop.

Fuses inside the vehicle



Fig. 221 On the dashboard on the driver side: lid of the fuse box.

Opening and closing the fuse box located below the instrument panel

- **Open:** fold the cover down »» Fig. 221.
- **Close:** push back the cover it in until it clicks into place.

Identifying fuses below the dashboard by colours

Colour	Current intensity in amps
Orange	5
Brown	7.5
Red	10
Blue	15
Yellow	20
White or transparent	25
Green	30
Orange	40
Red	50

NOTICE

- Always carefully remove the fuse box covers and refit them correctly to avoid problems with your vehicle.
- Protect the fuse boxes when open to avoid the entry of dust or humidity. Dirt and humidity inside fuse boxes can cause damage to the electrical system.

Fuses in the engine compartment

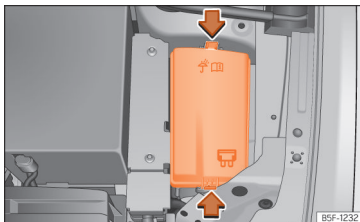



Fig. 222 In the engine compartment: lid of the fuse box.

To open the engine compartment fuse box

- Raise the bonnet »»  on page 325.
- Press the locking tabs to unlock the fuse box cover »» Fig. 222.
- Then lift the cover out.

- To **fit** the cover, place it on the fuse box. Push the locking tabs down until they click audibly into place.

Replace a blown fuse

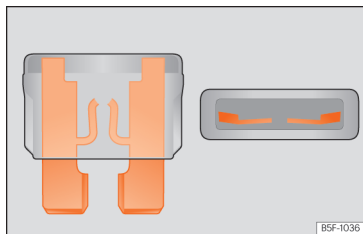


Fig. 223 Image of a blown fuse.

Preparations

- Switch off the ignition, lights and all electrical equipment.
- Open the corresponding fuse box »» page 321, »» page 322.

Recognise a blown fuse

A blown fuse can be recognised if the metal strip is melted »» Fig. 223.

- Point a lamp at the fuse to see if it has blown.

To replace a fuse

- Remove the fuse.
- Replace the blown fuse by one with an *identical* amperage rating (same colour and markings) and *identical* size.
- Replace the cover again or close the fuse box lid.

Fuse placement

Fuses in the vehicle interior

No.	Consumers/Amps	
3	Trailer	25
4	SCR, Adblue®	20
5	Automatic gearbox lever	25
6	Interior light	30
8	Sunroof	20
7	Heated seats	30
9	Left door	30
11	Trailer	15
12	Right lights	40
13	Central locking	40
14	External Ethernet Amplifier	30
16	Airbag	7.5
17	SCR, engine relay, 1.5	10
18	KESSY	7.5

No.	Consumers/Amps	
19	Instrument panel	7.5
20	Connectivity Box	7.5
21	Rear camera	7.5
24	4x4 Haldex Control Unit	15
25	RGS+EBSS front seat belts	25
26	Right door	30
27	RGS+EBSS front seat belts	25
28	PHEV. Switching off the high voltage system for rescue tasks. Identified by a yellow label.	10
29	Trailer	15
30	Radio	30
31	Trailer	25
34	230V socket	30
35	Left lights	40
36	Air conditioner fan	40
37	Electric rear lid	30
39	Heated steering wheel	10
40	Alarm horn	7.5
41	Gateway	7.5
42	Automatic gearbox lever	7.5
43	Air conditioning and heating control panel, rear window heating, AA compressor	10

No.	Consumers/Amps	
44	Diagnosis, handbrake switch, light switch, reverse light, interior lighting, lit-up door sill	7.5
45	Steering column	7.5
46	Radio display	7.5
47	Driving mode	10
48	USB	7.5
52	12V socket	20
58	Parking sensors, park distance control unit, front camera, radar	7.5
59	Reverse switch, clima sensor, electrochromic mirror	7.5
60	Diagnosis, headlight control unit, headlight adjuster	7.5
61	Starter motor; clutch sensor	7.5
65	Sound amplifier	10
66	Rear window wiper	15
67	Heated rear window	30

In-line fuse/Amps

230 V rear power sockets	30
Electric driver's seat	15

Fuse arrangement in engine compartment

No.	Consumers/Amps	
2	Engine control unit	7.5
3	Fuel pump control unit	7.5/10/ 20
4	Left headlight KL 30 Signal	15
5	Right headlight KL 30 Signal	15
7	Automatic gearbox pump	30
8	KL 30 Signal brake servo	40
9	Horn	15
10	Front windscreen washer	30
11	PHEV Climate	7.5
12	Automatic gearbox control unit	15/30
13	ESP control unit	25
14	Standheizung	20
15	ESP control unit	40
16	PHEV, Automatic gearbox unit	50
17	PTC	40
18	PTC	40
20	Front electronic differential	15
21	Engine control unit	7.5
22	Starter motor	30
23	Engine control unit (diesel/petrol)	15

No.	Consumers/Amps	
24	Engine sensors	7.5/10
25	Engine sensors	7.5/10
26	Engine power supply	7.5/10/1 5
27	Lambda probe	10/15
28	Engine	10/20
29	Fuel pump control unit	15/20/3 0
30	Pressure pump 1.0	10
33	PTC	40

 Note

- In the vehicle, there are more fuses than those indicated in this chapter. These should only be changed by a specialised workshop.
- Positions not containing a fuse do not appear in the following tables.
- Some of the equipment listed in the tables below pertain only to certain versions of the model or are optional extras.
- Please note that the above lists, while correct at the time of printing, are subject to change.

Changing bulbs

Change a bulb

LED technology lights

Full-LED headlights handle all light functions (daylight, side light, turn signal, dipped beam and route light) with light emitting diodes (LEDs) as a light source.

Full-LED headlights are designed to last the lifetime of the car and light bulbs cannot be replaced. In case of headlight failure, go to an authorised workshop to have it replaced.

The fog lights, tail lights, number plate light, side turn signals and additional brake light are all LED bulbs. With this in mind, they should be replaced by a technical service.

Checking and refilling levels

Engine compartment

Working in the engine compartment

The engine compartment of the vehicle is a dangerous area. You should only perform works in the engine compartment if you have good knowledge of the necessary operations and the general safety measures, and if you have adequate tools, means and operating fluids. Works performed inadequately, could lead to serious injuries »» » ⚠. In this case, seek a specialised workshop to perform all the works. SEAT recommends visiting a SEAT dealership for this.

Before performing any work in the engine compartment, always park the vehicle on level and firm ground, taking all necessary safety precautions.

⚠ WARNING

Any accidental movement of the vehicle during maintenance work could cause serious injuries.

- Never perform works underneath the vehicle without having first immobilised it to prevent it from moving. When working under the vehicle with the wheels on the ground, the vehicle must be on a level surface and the wheels must be locked.
- If work must be performed underneath the vehicle, take the extra precaution of supporting it safely using suitable assembly support. The jack is not suitable for this purpose and may not withstand, which could lead to serious injuries.
- The Start-Stop system must be switched off manually.

⚠ WARNING

The engine compartment of any vehicle is a dangerous area in which serious injuries can be caused!

- When performing any type of work, always ensure you are extremely cautious, and bear in mind the general safety measures. Never put yourself at risk.
- Never perform works in the engine compartment if you do not have solid knowledge of the necessary operations. If you are unsure of what needs to be done, seek a speci-

alised workshop to perform the works. Works performed inadequately, could lead to serious injuries.

- Never open or close the bonnet if you see steam or coolant escaping from the engine compartment. Steam or hot coolant can cause severe burns. Always wait until you stop hearing or seeing the steam or coolant discharging from the engine compartment.
- Before opening the bonnet, always wait for the engine to cool down.
- Touching hot engine or exhaust system components could result in skin burns.
- Turn off the ignition and keep the vehicle key in a safe place at a safe distance from the vehicle to prevent the ignition from being turned on and the combustion engine started by mistake.
- Always keep children away from the engine compartment and never leave them unsupervised.
- When the motor is hot, its cooling system is pressurised. Do not open the expansion tank cap, hot coolant may splash out and cause severe burns and other injuries.
 - Turn the coolant expansion tank cap slowly and very carefully anticlockwise while pressing it down slightly.
 - Always protect your face, hands and arms from the hot coolant and steam with a large thick cloth.

- When refilling operating fluids, ensure they do not spill onto the components of the engine or onto the exhaust system. These liquids could cause a fire.

WARNING

The electrical system is under high voltage and can cause electrical shocks, burns, serious injuries and even death!

- Never short circuit the electrical system. The 12-volt battery could explode.
- To reduce the risk of electric shock and serious injury, never touch the electrical wires of the ignition system while the engine is running or when starting.

WARNING

There are rotating parts in the engine compartment which could cause serious injury.

- Never insert your hand in the radiator fan or around that area. All the rotor blades can cause serious injuries. The fan activates depending on the temperature and can switch on automatically, even if the ignition is off.
- If any work has to be done during engine start-up or when it is running, take into account that the rotating parts (e.g. the poly-V belt, alternator and the radiator fan) and the high-voltage ignition system pose a fatal hazard. Always act with extreme care.

- Ensure that no part of your body, or any jewellery or tie, loose clothing, loose long hair can become trapped in the rotating parts. Before performing works in the engine compartment, remove any jewellery or tie you may be wearing, tie up your hair if it is long and gather any loose clothing.

- Do not press the accelerator pedal while not paying attention. Always do so with extreme care. The vehicle could start moving even when the electronic parking brake is engaged.

- Do not leave objects in the engine compartment, e.g. rags or tools.

WARNING

The operating fluids and some materials of the engine compartment are highly flammable and could cause a fire and serious injuries!

- Never smoke in the vicinity of the engine compartment.
- Never perform works close to unprotected flames or sparks.
- When you must perform works on the on-board 12 volt electrical system, bear in mind the following:

- Always disconnect the 12 volt battery. Ensure the vehicle is unlocked when disconnecting the 12-volt battery, otherwise the anti-theft alarm will trigger.

- Never perform works in the vicinity of heating elements, water boilers or unprotected flames.

- Always have a fire extinguisher close-by, ensuring it is operational and had been checked.

NOTICE

When refilling or changing the operating fluids, ensure you pour the correct fluids into their corresponding filler caps. Using the wrong operating fluids can lead to serious malfunctions and motor damage.

For the sake of the environment

Operating fluids that overflow from the vehicle contaminate the environment. Therefore, check underneath the vehicle on a regular basis. If there are marks left by operating fluids on the ground, consult a specialised workshop and request the vehicle be checked. If any operating fluid leaks out, dispose of it in the correct manner.

Preparing the vehicle for work in the engine compartment

Before performing works in the engine compartment, always perform the following operations in the order indicated >>> ⚠:

1. Place the vehicle on level and firm ground, taking all necessary safety precautions.
2. Press the brake pedal and keep it pressed until the ignition is switched off.
3. Apply the electronic parking brake.
4. *Manual transmission:* place the gear lever in neutral.
Automatic transmission: press the parking lock button **P**.
5. Switch the ignition off >>> page 152.
6. Remove the vehicle key from the vehicle and store it outside to avoid inadvertently starting the engine.
7. Wait for the engine to cool down sufficiently.
8. Always keep other people away from the engine compartment.
9. Immobilize the vehicle so that it cannot move.

⚠ WARNING

For your own safety, do not ignore this important check list, otherwise this could cause accidents and serious injuries.

- Always follow the indications on the check list and always bear in mind the general safety measures.

Opening and closing the bonnet

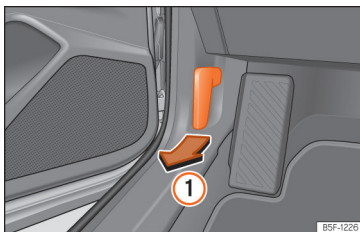


Fig. 224 Release lever in the driver's footwell area.

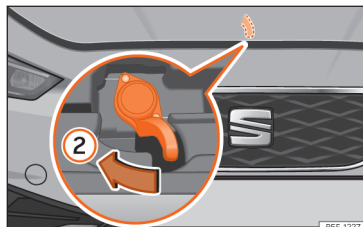


Fig. 225 Lever under the bonnet.

Opening the bonnet

The bonnet is released from inside the vehicle. Before opening the bonnet, make sure that the windscreen wiper arms are in place against the windscreen.

- Open the door and pull the lever that is underneath the instrument panel >>> Fig. 224 ①.
- To lift the bonnet, press towards the left on the lever located under the bonnet, in the centre >>> Fig. 225 ②. The fastening hooks are unlocked.
- The bonnet can be opened. Release the bonnet stay and secure it in the fixture designed for this in the bonnet.

Closing the bonnet

- Slightly lift the bonnet.
- Release the bonnet stay and replace it in its support.
- At a height of approximately 20 cm let it fall so it locks.

If the bonnet does not close, do not press downwards. Open it again and let it fall as mentioned above.

WARNING

Make sure that the bonnet is properly closed. If it opens when driving, it can cause an accident.

NOTICE

In certain weather conditions, ice or snow may build up between the bonnet and windscreen; do not force the bonnet open until you are sure that there is no ice or snow, especially in the hinge area.

NOTICE

To avoid damage to the bonnet and to the windscreen wiper arms, only open it when the windscreen wipers are in place against the windscreen.

Fluids and consumables

Introduction

All fluids and consumables, such as engine coolant or vehicle batteries, are subject to continuous development. For this reason, whenever a fluid or consumable needs to be replaced, please contact a specialist workshop.

SEAT dealers always promptly receive information about any modifications.

WARNING

If unsuitable fluids and consumables are used or used improperly, accidents, injuries, burns and severe poisoning can occur.

- Only store operating fluids in their original containers, tightly closed.
- Never store operating fluids in empty food cans, bottles or other empty containers, as they could be ingested by somebody.
- Keep all fluids and consumables out of reach of children.
- Always read and observe the information and warnings given on containers of operating fluids.
- When using products that emit harmful vapours, always work outdoors or in a well-ventilated area.

NOTICE

Use only appropriate operating fluids. Never confuse operating fluids. This could result in serious malfunctions and motor damage!

For the sake of the environment

Leakages of operating fluids can contaminate the environment. If any operating fluid leaks, collect it in an appropriate container and dispose of it properly and in an environmentally friendly manner.

Cooling system

Introduction

Only carry out work on the motor cooling system yourself if you are familiar with the necessary operations and the generally applicable safety measures, and if you have the appropriate tools, equipment and operating fluids. Works performed inadequately could lead to serious injuries. In this case, seek a specialised workshop to perform all the works. SEAT recommends visiting a SEAT dealership for this.

⚠ WARNING

Engine coolant is toxic!

- Only store coolant in its original container, tightly closed and in a safe place.
- Never store motor coolant in empty food cans, bottles or other empty containers, as it could be ingested by another person.
- Always keep motor coolant out of reach of children.
- Ensure that the coolant fluid additive percentage is correct, taking into account the lowest ambient temperature expected in the location where the vehicle is to be used.
- When the outside temperature is very low, the coolant could freeze and the vehicle could be immobilised. In this case, the heating would not work either and inadequately dressed passengers could die of cold.

🌿 For the sake of the environment

Coolants and additives can contaminate the environment. If any operating fluid leaks out, collect it and dispose of it properly and in an environmentally friendly manner.

Coolant specifications

The factory fitted motor cooling system is filled with a mixture of specially treated water and at least 40% coolant additive G12evo (TL-VW 774 L).

Get information from a specialist workshop about which coolant is suitable for your vehicle. SEAT recommends visiting a SEAT dealership for this.

To protect the engine cooling system, the additive percentage should **always** be at least 40%. If more antifreeze protection is required for climatic reasons, the additive proportion can be increased. However, it should only be increased up to a maximum of 55 %, otherwise the antifreeze protection would be reduced and the cooling effect would be impaired.

The G12evo (TL-VW 774 L) can be recognised by its lilac colouring. This mixture of water and additive not only provides antifreeze protection down to -25°C (-13°F), but also protects the light alloy parts of the cooling system against corrosion, prevents limescale build-up and considerably raises the boiling point of the coolant.

When topping up the coolant, a mixture of **distilled water** and at least 40% of the appropriate coolant additive should be used for optimum corrosion protection »» page 330.

⚠ WARNING

If the vehicle's cooling system does not have sufficient antifreeze protection, the engine could fail and this could result in serious injury.

- Ensure that the coolant fluid additive percentage is correct, taking into account the lowest ambient temperature expected in the location where the vehicle is to be used.
- When the outside temperature is very low, the coolant could freeze and the vehicle could be immobilised. In this case, the heating would not work either and inadequately dressed passengers could die of cold.

ⓘ NOTICE

Never mix the original additives for the G12evo coolant (TL-VW 774 L) with motor coolant fluid not authorised by SEAT.

- If the fluid in the expansion tank does not have a pink colour (resulting from mixing the lilac additive with distilled water), but is, for example, brown, the suitable coolant may have been mixed with another unsuitable one. The coolant must be changed as soon as possible if this is the case! Otherwise serious malfunctions or damage to the engine and the cooling system could occur!

For the sake of the environment

Motor coolant and its additives can pollute the environment. If any operating fluid leaks out, collect it and dispose of it properly and in an environmentally friendly manner.

Coolant tank

✓ Valid for: hybrid vehicles.

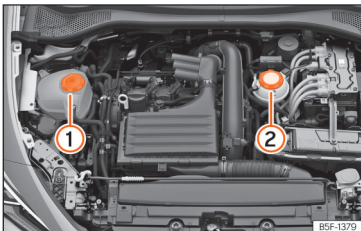


Fig. 226 Engine compartment: Coolant tanks

Hybrid vehicles have 2 independent coolant expansion tanks.

››› **Fig. 226**

- ① Coolant expansion tank for the combustion engine.
- ② Coolant expansion tank for the high-voltage system. Visually check the coolant level of the **high-voltage system Do not open it!** It is sealed.

If the coolant level in the **cooling system of the high-voltage system** is too low:

-  **Do not top up coolant!**
- Contact a specialised workshop immediately.

Check and refill the coolant

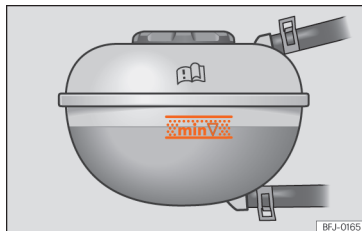




Fig. 227 In the front compartment: marking on coolant expansion tank.



Fig. 228 Front compartment: coolant expansion tank cap.

Previous steps

- Park the vehicle on a firm, flat surface.
- Wait until the engine has fully cooled ››› .
- Open the front bonnet.
- The motor coolant expansion tank can be recognised by the symbol on the cap  ››› **Fig. 228**

Check the level

When the vehicle is delivered (new vehicles), the coolant may be above the marked area. This is normal. It is not necessary to suck the coolant out.



- When the engine is cold, check the coolant level using the side marking on the expansion tank ››› **Fig. 227**. The coolant level should be between the marks.


- If the level is below the minimum level mark (**min**) on the tank, top up with coolant. When the motor is warm, the coolant level may be slightly above the upper mark.

Topping up the fluid

When the motor coolant level is too low, the coolant warning light comes on. In this case, immediately seek assistance from specialist personnel.

If the coolant level is too low and there is no workshop nearby, note the following:

- Always protect your face, hands and arms from hot coolant or steam by placing a suitable cloth over the cap of the motor coolant expansion tank.
- Carefully unscrew the cap ››› .
- Only top up with **fresh** coolant according to SEAT specifications ››› page 329.
- Only top up with coolant if there is still some coolant left in the expansion tank; otherwise the motor could be damaged! If you do not see any coolant in the expansion tank, **do not continue driving** and seek specialist assistance.
- If there is still some coolant left in the expansion tank, top up with coolant up to the tank's upper mark and check the level the next day. If the level drops **again**, go to a workshop and request a check of the cooling system.
- The coolant level must be between the marks on the expansion tank ››› Fig. 227. **Never exceed the top edge of the marked area** ››› .

- Screw the cap on tightly.
- If engine coolant with the recommended specifications is not available in an emergency, do not use any other coolant additive! In this case, top up with **distilled water** ›››  only. Next, ensure that the recommended additive is topped up as soon as possible in the correct proportion ››› page 329.

WARNING

Steam and hot motor coolant can cause severe burns.

- **Never open the front bonnet if you see or hear steam or coolant escaping from the front compartment. Always wait until you can no longer see or hear steam or coolant escaping. Touching hot parts can result in skin burns.**
- **Before opening the front bonnet, please note the following:**
 - Apply the electronic parking brake.
 - Always keep children away from the front compartment and never leave them unattended.

- **When the motor is hot, its cooling system is pressurised. Do not open the expansion tank cap, hot coolant may splash out and cause severe burns and other injuries.**

- Turn the cap slowly and very carefully anticlockwise while pressing it down slightly.
- Always protect your face, hands and arms from the hot coolant and steam with a large thick cloth.

NOTICE

Only use distilled water! Other types of water contain chemical substances that could cause significant corrosion damage. If you have added non-distilled water, have all of the motor cooling system fluid changed immediately by a specialist workshop.

- When topping up the, do not fill over the upper edge of the marked area ››› Fig. 227. Otherwise, when the temperature rises the excess fluid will be expelled from the motor cooling system and could cause damage.
- If the system leaks a lot of coolant, only refill once the motor has **cooled down completely**. If there is a significant loss of coolant, there may be leaks in the cooling system. Immediately go to a specialist workshop to have the system checked. This could result in motor damage.

- Do not add coolant if the expansion tank is completely empty! Air may have got into the cooling system. Do not continue driving and seek assistance from specialist personnel. This could result in motor damage.
- When changing the operating fluids, make sure that you pour the correct fluids into the correct filler necks. Using the wrong operating fluids can lead to serious malfunctions and motor damage.

Brake fluid

Check and refill the brake fluid



Fig. 229 Engine compartment: brake fluid reservoir cap.

Checking the brake fluid level


The brake fluid level must be between the **MIN** and **MAX** markings.

However, if the brake fluid level goes down noticeably in a short time, or drops below the **MIN** mark, there may be a leak in the brake system. Seek specialist assistance. A warning light on the instrument panel display monitors the brake fluid level.

Brake fluid level

The control lamp lights up red.

Brake fluid level is too low.

-  **Stop driving!**
- Check the brake fluid level.
- If the brake fluid level is too low, seek specialist assistance.

Changing brake fluid

We recommend that you have the brake fluid changed by a Technical Service.

WARNING

If the brake fluid level is low or unsuitable/old brake fluid is used, the brake system may fail or braking power may be reduced.

- Check the brake system and the brake fluid level regularly!
- When the brake fluid is used and brakes are subjected to extreme braking forces, bubbles of vapour form in the brake system. These bubbles can significantly reduce brak-

ing power, notably increasing braking distance, and could result in the total failure of the brake system.

- Be sure to always use the correct brake fluid. Only use brake fluid that expressly meets the VW 501 14 standard.
- You can buy VW 501 14 standard brake fluid in a SEAT dealership or a SEAT Official Service. If none is available, use only high-quality brake fluid that meets DIN ISO 4925 CLASS 4 standards, or USA Standards FMVSS 116 DOT 4.
- The replacement brake fluid must be new.
- Brake fluid should be stored in the closed original container in a safe place out of reach of children. Risk of poisoning!

NOTICE

Brake fluid should not come into contact with the vehicle paintwork, as it is abrasive.

Note

Brake fluid is an environmental pollutant. Collect any spilt service fluids and allow a professional to dispose of them.

Windscreen washer reservoir

Checking the level of the window washer tank and refilling it

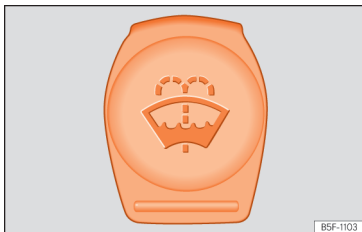


Fig. 230 In the engine compartment: blue cap of the windscreen washer tank.

Check the water level in the windscreen washer reservoir regularly and top up as required.

The window washer tank contains liquid detergent for the windscreen and rear window.

There is a sieve in the filler neck of the washer fluid tank. When filling the tank, this sieve retains large dirt particles so that they do not reach the nozzles. Do not remove the sieve except for cleaning. If the sieve is damaged or not fitted, these dirt particles could enter the system during filling and clog the windscreen washer nozzles.

- Raise the bonnet >>> on page 325.
- The windscreen washer reservoir is marked with the symbol on the cap.
- Check if there is enough fluid in the tank. Plain water is not enough to clean the windscreen and headlights. We recommend that you always add a product to the windscreen washer fluid.

Recommended windscreen wipers

- For the hottest seasons we recommend summer G 052 184 A1 for clear glass. Proportions of the mixture in the washer fluid tank: 1:100 (1 part concentrate per 100 parts water).
- All year round, G 052 164 A2 for clear glass. Approximate proportion of the winter mixture, up to -18°C (0°F): 1:2 (1 part concentrate per 2 parts water); otherwise, a 1:4 proportion of mixture in the washer fluid tank.

The capacity of the windscreen washer tank is approximately 3 litres.

NOTICE

If the water from the windscreen washer does not contain enough anti-freeze, it may freeze on the windscreen and rear window, reducing forward and rear visibility.

- In winter, ensure the windscreen washer contains enough anti-freeze.
- In cold conditions, you should not use the windscreen wiper system unless you have warmed the windscreen with the ventilation system. The antifreeze could freeze on the windscreen and reduce visibility.

NOTICE

Never mix an unsuitable antifreeze or other similar additives with the windscreen washer water. A greasy layer may be formed on the windscreen which will impair visibility.

- Use clean water with a window cleaner recommended by SEAT.
- If necessary, add a suitable antifreeze to the water in the reservoir.

NOTICE

- Do not mix cleaning products recommended by SEAT with other products. This could lead to flocculation and may block the windscreen washer jets.
- When topping up service fluids, make absolutely certain that you fill the fluids into the correct reservoirs. Using the wrong fluids could cause serious malfunctions.
- Lack of window washer fluid causes the view through the windscreen to be obscured.

Engine oil

General notes

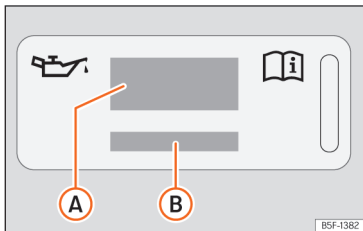


Fig. 231 In the engine compartment: engine oil label

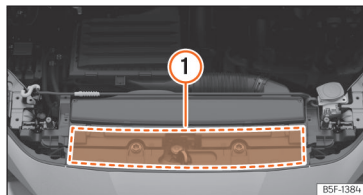


Fig. 232 In the engine compartment: area where the engine oil label is located

Key to the >>> **Fig. 231**:

- (A) Information about the engine oil standard.
- (B) Information about engine oil viscosity.

The engine comes with a special, multi-grade oil that can be used all year round.

Because the use of high-quality oil is essential for the correct operation of the engine and its long useful life, when topping up or changing oil, use only those oils that comply with VW standards.

For vehicles with an engine oil label

If the engine oil has to be topped up, use one of the oils shown on the label >>> **Fig. 231**.

The label with the prescribed standard is located at the front of the engine compartment >>> **Fig. 232** (1). If you use the recommended engine oil, you can top up the oil as often as necessary.

For vehicles without an engine oil label

Contact a specialised workshop or SEAT official service for information about the corresponding standard.

If the engine oil level is too low

If the recommended engine oil is not available, **in the event of an emergency** you can change the oil **once** with a maximum of 0.5 l of the next oil until the next oil change:

- *Petrol engines:* standard VW 504 00, ACEA C3, ACEA C4, API SN or IL-SAC GF-6A.
- *Diesel engines:* standard VW 507 00, ACEA C3, ACEA C4 or API CK-4.

SEAT recommends changing the oil at a specialised workshop. SEAT recommends an Official SEAT Service.

NOTICE

SEAT recommends the use of engine oils approved according to the appropriate VW standard. Use of engine oils that do not meet these quality requirements can cause engine damage.

SEAT recommends the use of Original SEAT Spare Part engine oils.

Engine oil additives

No type of additive should be mixed with the engine oil. The deterioration caused by these additives is not covered by the warranty.

NOTICE

0.5 l of engine oil of one of the indicated engine oil standards may be used, only in the event of an emergency and in exceptional cases.

NOTICE

Take the following into account if you have refilled with an engine oil different to those specified in the aforementioned standards, or by your SEAT technical service centre:

- There is no way of completely avoiding the danger of causing damage to the engine and particulate filter.
- You can continue driving with the vehicle if the refill was no more than 0.5 l of engine oil. Go to a specialised workshop as soon as possible and request an oil change. Otherwise, there is a danger of engine damage.
- If you have topped up more than 0.5 l of engine oil, drive with the engine at low load levels and within the medium RPM range as a maximum. Do not drive at more than 80 km/h and do not travel more than 300 km (approximately). Go to a specialised workshop as

soon as possible and request an oil change. Otherwise, there is a danger of engine damage.

- You are responsible for the risk of possible damage to the vehicle (engine, exhaust system). If in doubt, do not start the engine and request assistance from the technical service centre.
- Do not start the engine if you have topped up with a fluid other than engine oil. Request assistance from the technical service centre. Danger of engine damage!

Note

Before a long trip, we recommend finding an engine oil that conforms to the corresponding VW specifications and recommend keeping it in the vehicle. This way, the correct engine oil will always be available for a top-up if needed.

- If the label showing the engine oil specifications is missing >>> Fig. 231, please contact a specialist workshop.

Checking and topping up the engine oil level

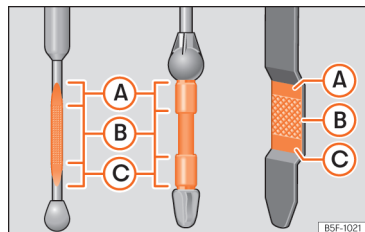


Fig. 233 Engine oil dipstick.



Fig. 234 Oil filler cap cover in the engine compartment.

Key to the >>> Fig. 233:

- (A) Do not top up oil in any case.
- (B) You can add oil but keep the level in that zone.

- Ⓒ The oil level is too low. Add oil up to zone Ⓑ.

Before opening the bonnet, read and observe the warnings >>> page 325, *Working in the engine compartment*.

Check the oil level


The engine oil dipstick indicates the level of the oil.

- Park the vehicle in a horizontal position.
- Briefly run the engine at idle speed until the operating temperature is reached and then stop.
- Wait for about two minutes.
- Locate the oil level dipstick. It can be recognized by its coloured upper end.
- Pull out the dipstick. Wipe the dipstick with a clean cloth and insert it again, pushing it in as far as it will go.
- Then pull it out again and check the oil level >>> Fig. 233. Top up with engine oil if necessary.

The oil should leave a mark between the areas Ⓐ and Ⓒ. It must never exceed zone Ⓐ.

Depending on how you drive and the conditions in which the vehicle is used, oil consumption can be up to 0.5 l/1000 km. Oil consumption is likely to be higher for the first 5,000 km. For this reason the engine oil level must be checked at regular intervals, preferably when filling the tank and before a journey.

Topping up engine oil

- Locate the engine oil filler cap. It can be recognized by the symbol  on the cover >>> Fig. 234.
- Unscrew cap from the oil filler mouth >>> Fig. 234.
- Carefully add oil in small quantities (no more than 0.5 l).
- To avoid adding too much oil, whenever you add a certain amount, wait about 2 minutes and recheck the oil level >>> page 336.
- If necessary, add some more oil.
- When the oil level reaches at least zone >>> Fig. 233 Ⓑ, carefully screw on the engine oil filler cap >>> Ⓣ.

Engine oil specification >>> page 334.

WARNING

Any work carried out in the engine compartment or on the engine must be carried out cautiously.

- When working in the engine compartment, always observe the safety warnings >>> page 325.

WARNING

Oil is highly inflammable! Ensure that no oil comes into contact with hot engine components when topping up.

NOTICE

If the oil level is above zone Ⓐ, do not start the engine. This could result in damage to the engine and catalytic converter. Contact a Technical Service.

For the sake of the environment

Under no circumstances should the oil level be above zone Ⓐ. Otherwise oil can be drawn in through the crankcase breather and leak into the atmosphere via the exhaust system.

Note

Before a long trip, we recommend finding an engine oil that conforms to the corresponding VW specifications and recommend keeping it in the vehicle. This way, the correct engine oil will always be available for a top-up if needed.

Engine oil change

We recommend that you have the engine oil changed by a Technical Service.

⚠ WARNING

Only change the engine oil yourself if you have the specialist knowledge required!

- Before opening the bonnet, read and observe the warnings »» page 325.
- Wait for the engine to cool down. Hot oil may cause burn injuries.
- Wear eye protection to avoid injuries, such as acid burns, caused by splashes of oil.
- When removing the oil drain plug with your fingers, keep your arm horizontal to help prevent oil from running down your arm.
- Wash your skin thoroughly if it comes into contact with engine oil.
- Engine oil is poisonous! Used oil must be stored in a safe place out of the reach of children.

📌 NOTICE

No additives should be used with engine oil. This could result in engine damage. Any damage caused by the use of such additives would not be covered by the factory warranty.

🌿 For the sake of the environment

- We recommend that you change the engine oil and the filter at a technical service centre.
- Never pour oil down drains or into the ground.
- Use a suitable container when draining the used oil. It must be large enough to hold all the engine oil.

Troubleshooting**🚗 Engine oil pressure too low**

The indicator lamp lights up red.

🚫 **Do not carry on driving!** Switch off the engine. Check the engine oil level.

- If this warning lamp 🚗 starts to flash, and is accompanied by **three audible warnings**, switch off the engine and check the oil level. If necessary, add more oil »» page 335.
- If the warning lamp 🚗 flashes although the oil level is correct, **stop driving**. Do not even run the engine at idle speed! Seek professional assistance.

🚗 Engine oil level too low

The indicator lamp lights up yellow.

- Check the engine oil level as soon as possible »» page 335.

- Change the oil as soon as you have the opportunity to do so.

**Fault in the oil level sensor**

The control lamp flashes yellow.

- Have the check done by a specialised workshop.
- Until then it is advisable to check the oil level every time you refuel.







12-volt battery**Introduction**

The 12 volt battery is located in the engine compartment or in the luggage compartment (PHEV hybrid vehicles). The 12 volt battery is checked and, if necessary, replaced as part of maintenance work.

All work on batteries requires specialist knowledge. Please refer to a SEAT Official Service or a workshop specialising in batteries: risk of burns or exploding battery!

The battery must not be opened! Never try to change the fluid level of the battery. Otherwise explosive gas is released from the battery that could cause an explosion.

Battery warning indications

-  Wear protective goggles.
-  Battery acid is extremely corrosive. Wear protective gloves and eye protection. Rinse any splashes of electrolyte with plenty of water.
-  Fires, sparks, open flames and smoking are prohibited.
-  The battery should only be charged in a well-ventilated zone. Risk of explosion!
-  Keep children away from acid and the battery.
-  Always follow the instruction manual.

If the vehicle is not used for long periods

The vehicle has a system for monitoring the current consumption when the engine is left unused for extended periods of time **>>> page 343**. Some functions, such as the interior lights, or the remote door opening, may be temporarily disabled to prevent the battery from running flat. These functions will come back on as soon as the ignition is switched on and the engine started.

WARNING

Working on the 12-volt battery and electrical system can cause severe burns, fire and electric shock. Always read and observe the following warnings and safety precautions before working on the battery:

- Before working on the 12-volt battery, switch off the ignition and all electrical consumers and disconnect the negative cable from this battery.
- Always keep children away from the 12-volt battery electrolyte and the battery itself.
- Always wear eye protection and protective gloves.
- The battery electrolyte is very corrosive it can cause skin burns and blindness. When handling the 12-volt battery, protect your hands, arms and face in particular from acid splashes
- Do not smoke while working and never work in the vicinity of naked flames or sparks.
- Avoid sparks caused by electrostatic discharges, just like when handling electric cables and devices.
- Never short the battery terminals.
- Never use damaged 12-volt batteries. They could explode. If the 12-volt battery is damaged, replace it immediately.
- Never use a frozen 12 volt battery. When the battery is discharged, it may freeze at temperatures close to 0°C (+32 °F). If the 12-volt battery is frozen, replace it immediately.

NOTICE

Do not expose the 12-volt battery to direct sunlight for a prolonged period of time.

- Ultraviolet rays can damage the battery casing.

NOTICE

If the vehicle is not to be used for a long period of time, protect the 12-volt battery from frost.

- The battery may freeze and, as a result, suffer irreparable damage.

Note

After starting the engine with a deeply discharged or newly replaced 12-volt battery, or after a jump start, some system settings (time, date, personalised comfort settings and programs) may be incorrectly set or deleted. Check and correct these settings once the battery is sufficiently charged.

Note

During the winter, the starting power may be reduced, and if necessary, the battery should be charged.

Check the electrolyte level



Fig. 235 Hybrid vehicles (PHEV): location of the battery in the luggage compartment

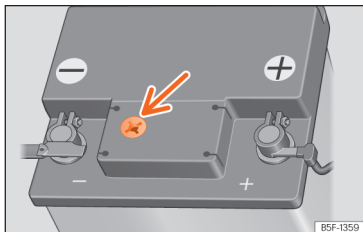


Fig. 236 Sight glass on the top of the 12 volt battery (schematic representation).

Access to the 12 volt battery

The 12-volt battery is located in the engine compartment (conventional vehicles) or under the luggage compartment floor (PHEV hybrid vehicles).

Valid for conventional and Mild Hybrid vehicles:

- Raise the bonnet >>> **△** in *Working in the engine compartment* on page 325.
- Lift the cover that protects the front of the battery.

Valid for hybrid vehicles (PHEV):

- Open the luggage compartment.
- Raise the floor of the luggage compartment >>> **page 286** to gain access to the 12-volt battery cover >>> **Fig. 236**.
- A suitable tool must be used to open and close the cover.

Check the level

The electrolyte level should be checked regularly in high-mileage vehicles, in hot countries and in older batteries.

- Check the colour display in the sight glass on the top of the battery >>> **Fig. 236**.
- If there are air bubbles in the window, tap the window gently until they disperse.

The “magic eye” indicator, located on the top of the battery changes colour, depending on the charge state and electrolyte level of the battery.

There are two different colours:

Yellow or colourless: The battery’s electrolyte level is too low. Go to a specialised workshop to have the battery checked and replaced if necessary.

Black: The battery’s electrolyte level is correct.

Charging, replacing, disconnecting and connecting the 12-volt battery

If you suspect that the 12-volt battery is damaged or defective, have it checked by a qualified specialist workshop.

Charging the 12-volt battery

Contact a specialist workshop for charging the 12-volt battery, as the battery model fitted in the vehicle in the factory uses a technology that requires limited voltage charging >>> **△**. SEAT recommends visiting a SEAT dealership for this.

Replacing the 12-volt battery

The 12-volt vehicle battery has been designed to suit its location and has special safety features. If a 12 volt battery needs to be replaced, the replacement battery must be installed by a qualified technician. SEAT recommends visiting a SEAT dealership. Component information regarding size, maintenance, power and safety characteristics to be met can be obtained from a qualified technician, who should have the necessary documentation and technical equipment. SEAT recommends visiting a SEAT dealership.

The degassing hole of the 12 volt battery must always be on side of the negative pole. The degassing hole on the side of the positive pole must always be sealed.

Only use maintenance-free 12 volt batteries that comply with the TL 825 06 and VW 7 50 73 standards. These standards must be dated October 2014 or later.


The 12 volt battery must always be replaced by a qualified technician, as the vehicle's electronic system must also be adjusted as part of the replacement. In addition, the battery parameters relating to operational safety can only be determined with the original battery. Only a qualified technician has both the right technology to make the adjustment and the correct replacement batteries.

The use of unsuitable batteries will invalidate the approval.


Vehicles with Start-Stop functions (»» page 159) are fitted with a special battery. Therefore, it must only be replaced with a battery of the same specifications.

Disconnecting the 12-volt battery

If the 12 volt battery is to be disconnected from the vehicle's electrical system, please note the following:

- Switch off all electrical consumers.
- Before disconnecting the battery, unlock the vehicle, otherwise the alarm will be triggered.
- First disconnect the negative cable and then the positive cable »» .

Connecting the 12-volt battery

- Switch off all electrical consumers before reconnecting the 12 volt battery.
- First reconnect the positive cable and then the negative one »» .

After connecting the 12 volt battery and switching on the ignition, several control lamps may light up. These lamps go out after a short distance at a speed of approx. 15 to 20 km/h (10 to 12 mph). If the warning lights do not go out, visit a specialist workshop and have the vehicle checked.

If the 12-volt battery has been disconnected for a long period of time, it is likely that the next service is not correctly indicated or calculated »» page 18. In this case it will be necessary to take into account the maximum maintenance intervals allowed »» page 362.

Vehicles with a "Keyless Access" system

»» page 90: If the ignition cannot be switched on after connecting the 12 volt battery, lock and unlock the vehicle from the outside. Then try to switch on the ignition again. If the ignition does not work, seek professional assistance.

WARNING

Attaching the 12-volt battery incorrectly or using unsuitable batteries may result in short circuits, fire and serious injury.

- Use only maintenance-free 12 volt batteries with an anti-spill system with the same properties, specifications and dimensions as the factory-fitted battery.

WARNING

Charging the 12-volt battery creates a highly explosive mixture of detonating gases.

- Only charge the 12-volt battery in a well-ventilated place.
- Never charge a 12-volt battery that is frozen or has thawed. When the battery is discharged, it may freeze at temperatures close to 0°C (+32°F).
- If the 12-volt battery has frozen, have it replaced without fail.
- A short circuit may occur if the wires are incorrectly connected to the poles. First connect the positive cable and then the negative one.

NOTICE

- Never connect or disconnect the 12-volt battery when the ignition is switched on or the engine is running. Also, never use a 12-volt battery that does not meet the vehicle's battery specifications. The electrical system or certain electronic components could be damaged and electrical malfunctions could occur.
- Never connect accessories that supply power, such as solar panels or battery chargers, to the 12-volt socket or cigarette lighter, to charge the 12-volt battery. This could damage the vehicle's electrical system.

For the sake of the environment

- The battery may contain toxic substances, such as sulphuric acid and lead. Dispose of the 12 volt battery in accordance with the applicable regulations.
- Electrolyte can contaminate the environment. If any operating fluid leaks out, collect it and dispose of it properly.

Troubleshooting**Alternator fault**

Only valid for: conventional vehicles.

The control lamp lights up in **RED**.

Stop driving! Stop the vehicle at the next opportunity and in a safe place. The vehicle battery stops charging from the alternator while driving. As the battery gradually discharges, switch off all electrical devices that are not essential.

- Switch off the ignition and any electrical consumers that are not required.
- Inform a specialised workshop and get the electrical system checked.

12 volt battery

The control lamp lights up in **RED**. The following messages may be displayed:

Error: 12 V battery not charging. Stop vehicle safely!

Error: 12V power supply. Stop safely! Manual!

Stop driving! Stop the vehicle at the next opportunity and in a safe place. The 12-volt battery will not be charged while driving or there is a fault in the on-board 12-volt network.

- Switch off the ignition and any electrical consumers that are not required.
- Contact a specialised workshop.
- Request a check of the electrical system.

12 volt battery

The indicator lamp lights up **YELLOW**. The following message is displayed:

Error: 12 V vehicle battery. Engine cannot be started. Go to the workshop.

There is a fault in the connection between the on-board network and the 12-volt battery.

If the drive system is switched off in this situation, it cannot be switched on again. If necessary, use the jump leads »» page 315 or seek assistance from qualified personnel.

- Contact a specialised workshop.
- Request a check of the electrical system.

12 volt battery

The indicator lamp lights up **YELLOW**. The following message is displayed:

Low level of the 12 V vehicle battery. Charge while driving

Starting capacity may be limited. If this driver message goes out after a certain amount of time, the vehicle's battery has recharged while driving and reached a sufficient level. If the driver message does not go out, take the vehicle to a specialized workshop.

12 volt battery

The indicator lamp lights up **YELLOW**. The following message is displayed:

Replace the 12V vehicle battery. Please visit workshop.

The 12 volt battery has almost reached the end of its service life.

- Contact a specialised workshop.
- Have the 12 volt battery checked and replaced if necessary »» page 339.

12 volt battery

The indicator lamp lights up **YELLOW**. The following message is displayed:

Error: 12V power supply. Visit the workshop

There is a fault in the 12-volt power supply:

- Contact a specialised workshop.
- Have the electrical system checked.

48-volt battery

General information

✓ Valid for: Mild Hybrid vehicles (MHEV)

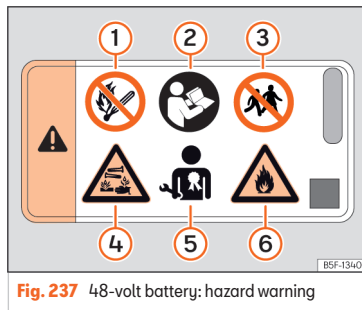


Fig. 237 48-volt battery: hazard warning

- ① Never expose the 48 volt battery to sources of fire, sparks or unprotected flames.
- ② The instruction manual and the workshop information contain further information and warnings to this regard.
- ③ Always keep children away from the 48 volt battery.
- ④ If the 48-volt battery is damaged, fluid can leak and very corrosive acids can form. The battery should only be handled by qualified personnel.

- ⑤ All maintenance works involving the 48 volt battery should only be performed by duly qualified and trained technical staff .
- ⑥ Take care when handling flammable substances.

In addition to a 12-volt battery, the vehicle may be fitted with a 48-volt battery located underneath the front passenger seat.

The works that are to be carried out on the 48 volt battery should be performed exclusively by a specialised workshop with duly qualified technical staff, trained according to the SEAT guidelines.

Overview of the 48 volt system

The 48 volt system consists of the following components, among others:

- 48-volt battery
- 12V/48V voltage converter
- 48 volt alternator/starter motor
- Purple 48 volt cables

48 volt battery warnings

There is a hazard warning sign on the 48 volt battery »» **Fig. 237**.

WARNING

An inappropriate handling of the 48 volt battery can cause serious injuries or death.

- All maintenance works involving the 48 volt battery should only be performed by duly qualified and trained technical staff.
- Never make any changes to the 48 volt battery.

WARNING

Make sure the 48 volt battery does not come into contact with water or other fluids.

- Liquids may cause short circuits, electrical shocks and burns.

Troubleshooting

✓ Valid for: Mild Hybrid vehicles

Indicator lamps and driver messages on the instrument cluster display or infotainment system:

48 volt battery

The indicator lamp lights up **red** while driving. The following message is displayed:

Error: 48V electrical system. Stop safely! Check the manual.

The charge level of the 48 volt battery is too low.

- Park the vehicle in a safe place.
- Switch off the ignition and wait for 3 seconds.
- Switch ignition back on.
- The indicator lamp lights up yellow.
- Leave the engine running with the vehicle stopped until the warning lamp switches off.
- Start driving when all the warning lamps have switched off.

If the yellow warning lamp does not switch off within 3 minutes, seek professional assistance.

48 volt battery

The warning lamp lights up **yellow** when the vehicle is stopped. The following message is displayed:

Error: 48V electrical system. Do not start driving. Check the manual.

The charge level of the 48 volt battery is too low.

- Do not start driving.
- Leave the engine running with the vehicle stopped until the warning lamp switches off.
- Start driving when all the warning lamps have switched off.

If the yellow warning lamp does not switch off within 3 minutes, seek professional assistance.

Energy management

Optimisation of the starting capacity

Energy management controls the electrical power distribution so that there is always enough electrical power to start the engine.

If a vehicle with a conventional energy system remains stationary for a long period of time, the electrical devices, for example in the electronic ignition lock, discharge the battery. Under certain circumstances, this can lead to a lack of electrical power to start the engine.

In your vehicle, a smart energy management system is responsible for distributing the electrical energy. This clearly improves the starting performance and service life of the battery.

The main functions incorporated in the power management system are **battery diagnosis, residual current management and a dynamic power management system.**

Battery diagnostics

Battery diagnostics determine the status of the battery on an ongoing basis. The battery voltage, current and temperature are monitored for this purpose. This is used to determine the battery's charge level and efficiency.

Residual current management system




The residual current management reduces energy consumption while the vehicle is stationary. When the ignition is switched off, it manages the power supply to the various electrical devices. In doing so, it takes into account the battery diagnostic data.

Depending on the battery's charge level, it disconnects electrical devices one after the other to avoid over-discharging the battery and to maintain starting capacity.

Dynamic energy management system

Energy generated while driving is distributed by the dynamic energy management system to the electrical devices according to their energy requirements. It also ensures that no more energy is consumed than is generated, thus ensuring an optimal battery charge level.

Note

- **The energy management system also cannot override the limits imposed by the laws of physics. Please note that the capacity and service life of the battery are limited.**
 - **When there is a risk that the vehicle will not start, the alternator power failure or low battery charge level warning lamp will be shown**
-    page 341.

Discharged battery

Maintaining starting capacity has top priority. Battery strain is considerable on short journeys, city driving and in the cold season of the year.

In these situations, a lot of energy is required but very little is generated. If the engine is stopped and at the same time the electrical devices are switched on, the battery can become discharged to a critical point. In this case energy is consumed without being generated at the same time.

In these situations you will notice that the energy regulation system performs active energy distribution adjustment.

Vehicle stationary for a long period of time

If you do not drive the vehicle for a few days or weeks, adjustments will be made to reduce consumption or the electrical devices will be deactivated one by one. This reduces energy consumption and the starting capacity is maintained for longer. Some comfort functions may not be available under certain circumstances. The comfort functions will be available again when the ignition is switched on and the engine is started.

With the engine stopped

If you listen to the radio, for example, while the engine is stopped, the battery will be discharged.

If the energy consumption means there is a risk that the engine will not start, a text will be displayed in vehicles with a driver information system.

This driver message indicates that the engine must be started to recharge the battery.

With the engine running

The battery may discharge despite the fact that energy is being generated while the vehicle is in motion. This is particularly the case if too little energy is generated and too much is consumed at a time while the battery's level of charge is not optimal.

To restore the energy balance, the devices that consume the most energy are either temporarily adjusted or deactivated. Heating systems, in particular, consume a lot of energy. If you notice, for instance, that the seat heating or the rear window heater is not working, they may have been temporarily switched off or regulated to a lower heat output. These systems can be used again as soon as the energy balance has been restored.

If necessary, you may also notice a slight idling speed boost. However, this is normal and should not cause you any concern. Boosting the idling speed generates additional energy and charges the battery.

Wheels and tyres

Important information about wheels and tyres

General notes

- When driving with **new tyres**, be especially careful during the first 600 km (300 miles).
- If you have to drive over a kerb or similar obstacle, drive very slowly and as near as possible at a right angle to the obstacle.
- Check from time to time if the tyres are damaged (punctures, cuts, cracks or dents). Remove any foreign objects embedded in the treads.
- Damaged wheels and tyres must be replaced immediately.
- Keep grease, oil and fuel off the tyres.
- Replace any missing valve caps as soon as possible.
- Mark the wheels before taking them off so that they rotate in the same direction when put back.
- When removed, the wheels or tyres should be stored in a cool, dry and preferably dark place.

Low profile tyres

Low profile tyres have a wider tread, a larger wheel diameter and a lower sidewall height. Therefore, its driving behaviour is more agile.

Low profile tyres may deteriorate more quickly than standard tyres, for instance due to strong knocks, potholes, manhole covers and kerbs. Correct tyre pressure is very important »» page 347.

To avoid damage to tyres and wheels, drive with special care when driving on roads in poor condition.

Visually check your wheels every 3000 km.

If the tyres or rims have received a heavy impact or have been damaged, have a specialised workshop check whether or not it is necessary to change the tyre.

Low profile tyres may deteriorate more quickly than standard tyres.

Concealed damage

Damage to tyres and rims is often not readily visible. If you notice unusual **vibration** or the car **pulling to one side**, this may indicate that one of the tyres is damaged. Reduce speed immediately if there is any reason to suspect that damage may have occurred. Inspect the tyres for damage. If no external damage is visible, drive slowly and carefully to the nearest specialised workshop and have the car inspected.

Foreign objects inserted in the tyre

- Do not remove foreign bodies if they have penetrated through the tyre wall!
- If the vehicle comes with a tyre mobility system, where necessary seal the damaged tyre as shown in section »» page 360.

Use a specialised workshop for repair or replacement. SEAT recommends visiting a SEAT dealership for this.

The sealant at the lower part of the tyre tread wraps around the foreign body and provisionally seals the tyre.

Tyres with directional tread pattern

An arrow on the tyre sidewall indicates the direction of rotation on single drive tyres. Always note the direction of rotation indicated when mounting the wheel. This makes sure that optimal use is made of tyre properties in terms of aquaplaning, grip, excessive noise and wear.

Subsequent fitting of accessories

If you wish to change or fit wheels, rims or wheel trims, we recommend that you consult with a SEAT Official Service for advice regarding current techniques.

Speed symbols

The speed rating indicates the maximum speed permitted for the tyres.

P max. 150 km/h (93 mph)


Q	max. 160 km/h (99 mph)
R	max. 170 km/h (106 mph)
S	max. 180 km/h (112 mph)
T	max. 190 km/h (118 mph)
U	max. 200 km/h (124 mph)
H	max. 210 km/h (130 mph)
V	max. 240 km/h (149 mph)
Z	max. 240 km/h (149 mph)
W	max. 270 km/h (168 mph)
Y	max. 300 km/h (186 mph)

WARNING

- **New tyres do not have maximum grip during the first 600 km. Drive particularly carefully to avoid possible accidents.**
- **Never drive with damaged tyres. This may cause an accident.**
- **If you notice unusual vibrations or if the vehicle pulls to one side when driving, stop the vehicle immediately and check the tyres.**
- **Never use old tyres or those with an unknown history of use.**

New wheels and tyres

It is best to have all wheels and tyres serviced by a specialised workshop. There they have the required knowledge, the special tools and the corresponding spare parts.

- Even winter tyres lose their grip on ice. If you have installed new tyres, drive the first 600 km carefully and at a moderate speed.
- All four wheels must be fitted with tyres of the same type, size (rolling circumference) and, if possible, tread pattern.
- When changing tyres, do not change just one; change at least two on the same axle.
- If you want to equip your vehicle with a combination tyres and rims that are different to those fitted in the factory, inform your specialised workshop before purchasing them »» 

The sizes of the rims and tyres approved for your vehicle are listed in the vehicle documentation (e.g. EC Certificate of Conformity or COC document¹⁾). The vehicle documentation varies depending on the country of residence.

If the type of spare wheel is different from the normal wheels — e.g. in the case of winter tyres or particularly wide tyres — the spare wheel should only be used temporarily in the event of a puncture, and the vehicle should be driven with care. Refit the normal road wheel as soon as possible.

In vehicles with four-wheel drive, the 4 wheels must be fitted with tyres of the same brand, type and tread so that the traction system is not damaged by a difference in the number of turns of the wheels. Therefore, in the event of a puncture, only a spare wheel with the same perimeter as normal tyres should be used.

Manufacturing date

The manufacturing date is also indicated on the tyre sidewall (or on the inside face of the wheel):

DOT . . . 2220 . . .

it means, for example, that the tyre was manufactured in the 22nd week of 2020.

WARNING

- **Use only combinations of tyres and rims, as well as suitable wheel nuts, approved by SEAT. Otherwise the vehicle may be damaged, causing an accident.**
- **For technical reasons it is not possible to use wheels of other vehicles; in some cases not even wheels from the same vehicle model should be used.**
- **Always ensure that the tyres you have chosen have adequate clearance. When selecting replacement tyres, do not rely entirely on the nominal tyre size marked on the tyre, since the nominal tyre size can differ**

¹⁾ COC = certificate of conformity.

significantly depending on the manufacturer. Lack of clearance can damage the tyres or the vehicle and, as a result, endanger road safety. Accident hazard!

- Only use tyres that are over 6 years old in an emergency, and drive with due care.
- The fitting of tyres with run-flat properties is not permitted on your vehicle! Prohibited use can cause accidents or can damage your vehicle.
- If decorative hubcaps are subsequently fitted, make sure that they allow enough air in to cool the braking system. Accident hazard!
- Models with aerodynamic wheel rims and/or with bolt-on plastic elements (more closed design) increase the likelihood of ice and snow accumulating on the inside. This should be taken into account, depending on the driving situations, as snow or ice accumulated in the wheels can cause vibration in the vehicle when it drives at over 40 km/h. It is advisable to remove ice and snow from the inside of the wheels using hot water.
- If you drive on dirt or gravel tracks, the likelihood of stones becoming trapped inside wheel rims with plastic elements increases when driving at high speed or in a sporty manner. If you see that there are stones trapped between the aluminium wheel rim and the insert, you can attempt to remove them using pressurised water.

For the sake of the environment

Old tyres must be disposed of according to the laws in the country concerned.

Note

- A SEAT Service Centre should be consulted to find out whether wheels or tyres of different sizes to those originally fitted by SEAT can be fitted, and to find out about the combinations allowed between the front axle (axle 1) and the rear axle (axle 2).
- Never mount used tyres if you are not sure of their "previous history".

Tyre life

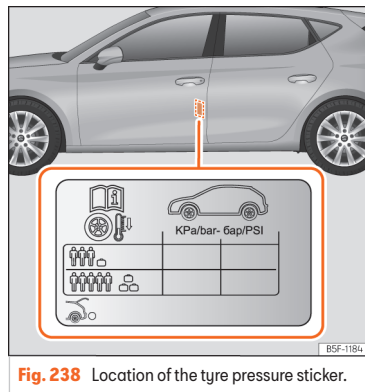


Fig. 238 Location of the tyre pressure sticker.

Correct inflation pressures and sensible driving habits will increase the useful life of your tyres.

- Check tyre pressure at least once a month, and also prior to any long trip.
- The tyre pressure should only be checked when the tyres are cold. Do not reduce the pressure of warm tyres.
- Adjust tyre pressure to the load being carried by the vehicle »» **Fig. 238**.
- In vehicles with a tyre pressure indicator, save the modified tyre pressure »» **page 357**.

- Avoid fast cornering and hard acceleration.
- Inspect the tyres for irregular wear from time to time.

Tyre pressure

The values of the tyre pressure are shown on the sticker label located on the rear frame of the front left door »» Fig. 238.

Insufficient or excessive pressure greatly reduces the useful life of the tyres and adversely affects vehicle performance and ride. Correct inflation pressures are very important, especially at **high speeds**.

The tyre pressure must be adjusted according to the load the vehicle is carrying. If the vehicle is going to be fully loaded, increase the tyre pressure to the maximum load value shown on the sticker label »» Fig. 238.

Do not forget the spare wheel when checking the tyre pressures: Keep this spare wheel inflated to the highest pressure required for the road wheels.

In the case of a minimised temporary spare wheel (125/70 R16 or 125/70 R18) inflate to a pressure of 4,2 bar as indicated on the tyre pressure label »» Fig. 238.

Driving style

Fast cornering, heavy acceleration and hard braking (squealing tyres) all increase tyre wear.

Wheel balance

The wheels on new vehicles are balanced. However, certain circumstances may lead to imbalance (run-out), which is detected as vibrations in the steering wheel.

Unbalanced wheels should be rebalanced, as they otherwise cause excessive wear on steering, suspension and tyres. A wheel must also be rebalanced when a new tyre is fitted or if a tyre is repaired.

Incorrect wheel alignment

Incorrect running gear alignment causes excessive tyre wear, impairing the safety of the vehicle. If you notice excessive tyre wear, you should check wheel alignment at a SEAT Official Service.

WARNING

Unsuitable handling of the wheels and tyres may lead to sudden tyre pressure losses, to tread separation or even to a blow-out.

- The driver is responsible for ensuring that all of the vehicle tyres are correctly inflated to the right pressure. The recommended tyre pressure is indicated on the label »» Fig. 238.
- Check tyre pressures regularly and ensure they are maintained at the pressures indicated. Tyre pressure that is too low could cause overheating, resulting in tread detachment or even burst tyres.

- Tyre pressure should be that indicated on the label when the tyres are cold at all times »» Fig. 238.
- Regularly check the cold inflation pressure of the tyres. If necessary, change the tyre pressure of the vehicle tyres while they are cold.
- Regularly check your tyres for damage and wear.
- Never exceed the maximum permitted speed or loads specified for the type of tyre fitted on your vehicle.

For the sake of the environment

Under-inflated tyres will increase fuel consumption.

Tread wear indicators



Fig. 239 Tyre profile: tread wear indicators.

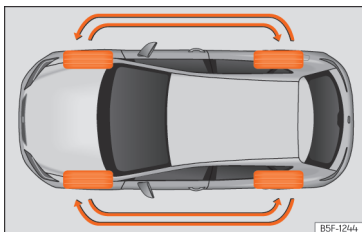


Fig. 240 Interchanging tyres.

Wear indicators around 1.6 mm high can be found on the base of the original tyre treads, ordered at regular intervals and running across the tread »» Fig. 239. The letters "TWI" or triangles on the sidewall of the tyre mark the position of the wear indicators.

The minimum permitted profile depth ¹⁾ have been reached when the tyres have worn down to the wear indicators. Replace the tyres with new ones »» ⚠.

With a sporty driving style, check the tread depth every 5,000 / 10,000 km (3,000 / 6,000 mi). When checking the tread depth, check the wear indicators in all the tyre grooves.

Changing wheels around

In order to wear the wheels in a uniform manner, it is recommended to interchange them regularly according to the diagram »» Fig. 240. The useful life of all the tyres will then be about the same time.

⚠ WARNING

The tyres must be replaced at the latest when the tread is worn down to the tread wear indicators. Failure to follow this instruction could result in an accident.

- Particularly in difficult driving conditions such as wet or icy roads. It is important that the tyre tread be as deep as possible and be approximately the same on the tyres of both the front and the rear axles.
- The scant driving safety due to insufficient tread depth is particularly evident in vehicle handling, when there is a risk of "aquaplaning" in deep puddles of water and when driving through corners, and braking is also adversely affected.
- The speed has to be adapted accordingly, otherwise there is a risk of losing control over the vehicle.

Wheel nuts

The **wheel bolts** and rims have been designed to be part of an assembly. When installing different wheels (for instance alloy wheels or wheels with winter tyres) it is important to use the correct wheel bolts with the right length and correctly shaped bolt heads. This ensures that wheels are fitted securely and that the brake system functions correctly.

The wheel bolts must be clean and turn easily. A special adapter is required to turn the anti-theft wheel bolts »» page 354.

⚠ WARNING

Wheel nuts should never be greased or oiled.

- Use only wheel bolts which belong to the wheel.
- If the prescribed torque of the wheel bolts is too low, they could loosen whilst the vehicle is in motion. Risk of accident! If the tightening torque is too high, the wheel bolts and threads can be damaged.

ⓘ NOTICE

See »» page 356 to find out the recommended tightening torque for wheel nuts for steel and alloy rims.

¹⁾ Follow the regulations of the country you are driving in.

Winter tyres

- Winter tyres must be fitted **on all four** wheels.
- Only use winter tyres that are approved for your vehicle.
- Please note that the maximum permissible speed for winter tyres may be lower than for summer tyres.
- Also note that winter tyres are no longer effective when the **tread** is worn down.
- After fitting the wheels you must always check the tyre pressures. When doing so, take into account the correct tyre pressures listed on the rear of the front left door frame **»» page 347**.

In winter road conditions winter tyres will considerably improve vehicle handling. The design of summer tyres (width, rubber compound, tread pattern) gives less grip on ice and snow. This applies particularly to vehicles equipped with **wide section tyres** or with **high speed tyres** (code letters H, V or Y on the sidewall).

Only use winter tyres of the correct type approved for your vehicle. The sizes of these tyres are specified in the vehicle's documents (e.g. EC Certificate of Conformity or COC¹⁾). The vehicle documentation varies depending on the country of residence.

Winter tyres lose a great deal of their properties when the **tread** is worn down to a depth of 4 mm.

¹⁾ COC = *certificate of conformity*.

The performance of winter tyres is also severely impaired by **ageing**, even if the tread is still much deeper than 4 mm.

A code letter indicating the speed limit is stamped on all winter tyres **»» page 345**.

In the infotainment system's **Vehicle settings** menu, a speed warning can be set in the **Tyres** menu.

Vehicles capable of exceeding these speeds must have an appropriate **sticker** attached so that it is visible to the driver. Suitable stickers are available from the SEAT Official Service and specialised workshop. Please note the regulations to this effect in your country.

"All-weather" tyres can also be used instead of winter tyres.

Using winter tyres with V-rating

Please note that the generally applicable 240 km/h (149 mph) speed for winter tyres with the letter V is subject to **technical restrictions; the maximum permissible speed for your vehicle may be significantly lower**. The maximum speed limit for these tyres depends directly on the maximum axle weights for your car and on the listed weight rating of the tyres being used.

It is best to contact a SEAT Official Service to check the maximum speed which is permissible for the V-rated tyres fitted on your car on the basis of this information.

WARNING

Exceeding the maximum speed permitted for the winter tyres fitted on your car can cause **tyre failure, resulting in a loss of control of the vehicle – risk of accident**.

For the sake of the environment

When winter is over, change back to summer tyres at an appropriate moment. In temperatures above +7°C (+45°F), performance will be improved if summer tyres are used. Rolling noise, wear and energy consumption will all be reduced.

Snow chains

Snow chains **are only permitted on the front wheels**, even on **4-wheel drive** vehicles.

- Check that they are correctly seated after driving for a few yards; correct the position if necessary, in accordance with the manufacturer's fitting instructions.
- Keep your speed below 50 km/h (30 mph).
- If there is a danger of being trapped despite having fitted the chains, it is best to disable the traction control (TCS) in the ESC **»» page 175**.

Snow chains will improve *braking ability* as well as *traction* in winter conditions.

For technical reasons, the use of snow chains is only permitted on the following rim and tyre combinations:

Tyres	Wheel rim	Chains
195/65 R15	6Jx15 ET43	Max. link 12 mm
205/55 R16	6.5Jx16 ET46	
205/55 R16	7Jx16 ET43	
225/45 R17	7.5Jx17 ET46	Max. link 9 mm
205/50 R17	7.5Jx17 ET46	
225/40 R18	7.5Jx18 ET46	
225/35 R19	8Jx19 ET49	
Other dimensions do not allow chains		

Remove any central wheel trims before fitting snow chains.

WARNING

The use of unsuitable or incorrectly fitted chains could lead to serious accidents and damage.

- Always use the appropriate snow chains.
- Observe the fitting instructions provided by the snow chain manufacturer.
- Never exceed the maximum permitted speeds when driving with snow chains.

NOTICE

- Remove the snow chains to drive on roads without snow. Otherwise they will impair vehicle handling, damage the tyres and wear out very quickly.
- Wheel rims may be damaged or scratched if the chains come into direct contact with them. SEAT recommends the use of covered snow chains.

Changing a wheel

Introduction

Only change a wheel yourself if you are familiar with the necessary operations and safety measures, if you have the necessary tools and if the vehicle is parked safely.

Preliminary actions

- Stop the vehicle on a level surface and in a safe place, as far away from road traffic as possible.
- Apply the electronic parking brake.
- Switch on the hazard warning lights.
- *Manual transmission:* engage 1st gear.
- *Automatic transmission:* switch on the parking lock P.
- If towing a trailer, unhitch the trailer from your vehicle.

- Lay out the on-board tools »»» page 313 and the wheel to be changed.
- Follow the legal provisions of each country (reflective vest, warning triangles, light beacon, etc.).
- Get all occupants out of the vehicle and keep them out of the danger zone (e.g. behind the guard rail).

WARNING

- Always observe the above steps and protect yourself and other road users.
- If you change the wheel on a slope, block the wheel on the opposite side of the car with a stone or similar to prevent the vehicle from moving.

Location and use of the temporary spare wheel

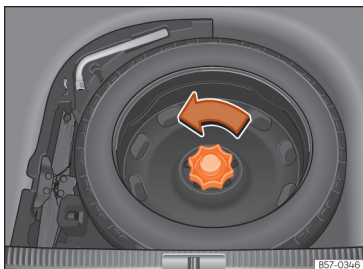


Fig. 241 In the luggage compartment: raised load floor.

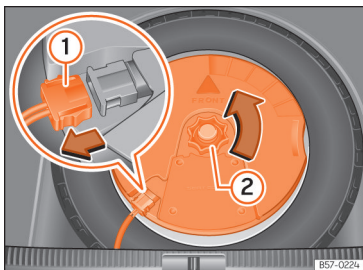


Fig. 242 In the boot: remove the subwoofer.

The temporary spare wheel is stored under the floor panel in the luggage compartment and is attached by a thumbnut.

The temporary spare wheel has been designed to be used for short periods of time. Have the tyres checked and replaced as soon as possible at a SEAT Official Service or at a specialised workshop.

The spare wheel must not be switched for a spare wheel from another vehicle.

Removing the temporary spare wheel

- Lift and hold up the floor panel to remove the temporary spare wheel >>> **page 286**.
- Turn the thumb wheel anticlockwise >>> **Fig. 241**.
- Take out the temporary spare wheel.

Getting the spare wheel out of vehicles fitted with the optional sound system (with subwoofer)

To remove the spare wheel, you must first remove the subwoofer.

- *Vehicles without a variable floor in the luggage compartment:* pull the floor of the luggage compartment (carpet) upwards to get it out.
- *Vehicles with a variable luggage compartment floor:* lift and secure the floor storage compartment as explained in >>> **page 286**.

- Disconnect the subwoofer's speaker cable >>> **Fig. 242 ①**.

- Turn the securing wheel anti-clockwise >>> **Fig. 242 ②**.

- Remove the subwoofer speaker and the spare wheel.

- When re-mounting the spare tyre, place the subwoofer on the base of the wheel rim with care. When doing so, the tip of the "FRONT" arrow on the subwoofer should point forward.

- Reconnect the speaker cable and firmly rotate the securing wheel clockwise so that the subwoofer system and wheel are firmly in place.

Chains

For technical reasons, snow chains must not be used on the temporary spare wheel.

If you have a puncture on one of the front wheels when using snow chains, fit the temporary spare wheel in place of one of the rear wheels. Fit the snow chains on the rear wheel that you have removed and replace the punctured front wheel with this wheel.

WARNING

- After fitting the temporary spare wheel, check the tyre pressures as soon as possible. Failure to do so may cause an accident. The tyre pressure is listed on the back of the left front door frame >>> page 347.
- Do not drive at over 80 km/h [50 mph] when the temporary spare wheel is fitted on the vehicle: risk of accident!
- Never travel more than 200 km using a temporary spare wheel.
- Avoid heavy acceleration, hard braking and fast cornering: risk of accident!
- Never use more than one temporary spare wheel at the same time, risk of accident.
- No other type of tyre (normal summer or winter tyre) may be fitted on the compact temporary spare wheel rim.
- If you are driving using the spare wheel, the ACC system could automatically switch off during the journey. Switch off the system when starting off.

Integral wheel trim

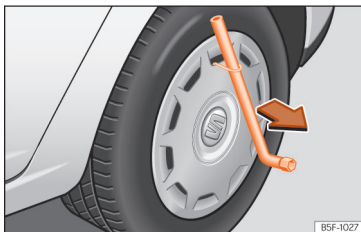


Fig. 243 Remove the wheel cover.

The wheel covers must be removed for access to the wheel bolts.

Removing

- Take the wheel brace and the wire hook from the vehicle tool kit >>> page 313.
- Hook the wire through one of the grooves of the trim.
- Insert the box spanner through the hook, rest it on the tyre and remove the wheel trim >>> Fig. 243.

Fitting

- Press the trim against the wheel so that the hole for the valve fits over the tyre valve.
- Make sure that the trim is correctly fitted all the way around the wheel. If you are using an anti-theft wheel lock, screw it in the opposite position to the valve.

Wheel bolt caps



Fig. 244 Wheel: wheel bolts with caps.

Removal

- Fit the plastic clip [vehicle tools >>> Fig. 212] over the cap until it clicks into place >>> Fig. 244.
- Remove the cap with the plastic clip.

The caps protect the wheel bolts and should be remounted after changing the tyre.

The **anti-theft wheel locking bolt** has a special cap. This only fits on anti-theft locking bolts and is not for use with standard wheel bolts.

Anti-theft wheel nuts

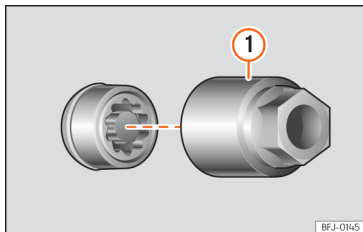


Fig. 245 Anti-theft wheel bolt with cap and adapter.

Loosening the anti-theft wheel bolt

- Remove the wheel trim or hub cap.
- Insert the special adapter >>> **Fig. 245** ① (vehicle tools >>> **page 313**) onto the anti-theft wheel bolt and push it on as far as it will go.
- Insert the wheel brace (vehicle tools) onto the adapter as far as it will go.
- Remove the wheel bolt >>> **page 354**.

Note

Make a note of the code number of the anti-theft wheel bolt and keep it in a safe place, but not in your vehicle. If you need a new adapter, you can obtain it from the SEAT Official Service, indicating the code number.

Loosening wheel nuts



Fig. 246 Tyre change: slacken the wheel bolts.

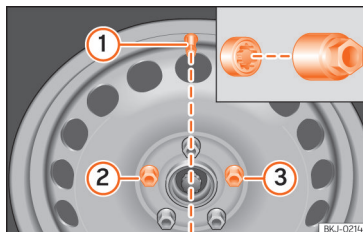


Fig. 247 Tyre change: tyre valve ① and the correct position for the anti-theft wheel locking bolt ② or ③.

Use only the wheel wrench belonging to the car to loosen the wheel bolts.

Loosen the wheel bolts only about one turn before raising the vehicle with the jack.

If the wheel bolt is very tight, carefully push on the end of the wheel wrench with your foot. Hold on to the vehicle for support and take care not to slip during this operation.

Loosening wheel nuts

- Fit the box spanner into the bolt as far as it will go >>> **Fig. 246**.
- Hold the wrench at the end and rotate the bolt approximately one turn anticlockwise >>> **△**.

Important information about wheel bolts

Factory-fitted rims and wheel bolts are specially matched during construction. Therefore, if different rims are fitted, the correct wheel bolts with the right length and heads must be used. This ensures that wheels are fitted securely and that the brake system functions correctly.

In certain circumstances, you should not even use wheel bolts from vehicles of the same model.

On wheels with integral hubcaps, the anti-theft wheel locking bolt must be screwed in the positions >>> Fig. 247 ② or ③, taking as reference the position of the tyre valve ①. Otherwise it will not be possible to mount the hubcap.

⚠ WARNING

If the wheel bolts are not properly tightened, they could come loose while driving and cause an accident, serious injury and loss of vehicle control.

- Use only wheel bolts which correspond to the rim in question.
- Never use different wheel bolts.
- Wheel bolts and threads should be clean, free of oil and grease, and it should be possible to screw them easily.
- To loosen and tighten wheel bolts, only use the wheel wrench that came with the car from the factory.

- The wheel bolts should only be loosened slightly (about one turn) before raising the vehicle with the jack. Risk of accident!
- Never apply grease or oil to wheel bolts or to the wheel hub threads. Even if the bolts have been tightened to the prescribed torque, they could come loose while driving.
- Never loosen the screwed joints of wheel rims with bolted ring trims.
- If wheel bolts are tightened below the prescribed torque, the bolts and rims could come loose while driving. If tightening torque is too high, the wheel bolts or threads can be damaged.

Raise the vehicle

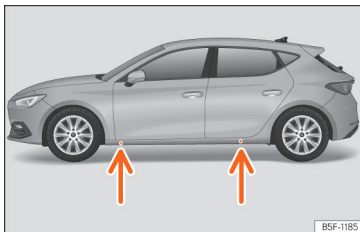


Fig. 248 Jack position points.

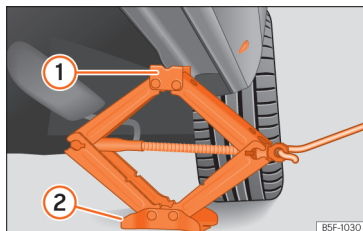


Fig. 249 Crossbar: mounting the jack on the vehicle.

- Rest the jack (vehicles tools) on firm ground. If necessary use a large, strong board or similar support. If the surface is slippery (for example tiles) place the jack on a rubber mat or similar to prevent it from slipping >>> ⚠.
- Look on the strut for the mark of the jack support point (sunken area) closest to the wheel to be changed >>> Fig. 248.
- Turn the jack crank handle, located below the strut support point, to raise it until the tab ① >>> Fig. 249 is below the housing that is provided.
- Align the jack so that the tab ① "grips" onto the housing provided on the cross member and the mobile base ② is resting on the ground. The base plate ② should fall vertically with respect to the support point ①.
- Continue turning the jack until the wheel is slightly lifted off the ground.

⚠ WARNING

The factory-supplied jack is only designed for changing wheels on this model. On no account attempt to use it for lifting heavier vehicles or other loads. Risk of injury.

- Make sure the jack remains stable. If the surface is slippery or soft, the jack could slip or sink, respectively, with the consequent risk of causing injuries.
- Lift the vehicle using only the jack supplied from the factory. Other jacks, even those approved for other SEAT models could slip, with the consequent risk of injury.
- Place the jack only at the support points provided on the strut and align it. Otherwise, the jack could slip because it does not have sufficient grip on the vehicle: risk of injury!
- You should never place a body limb such as an arm or leg under a raised vehicle that is solely supported by the jack.
- If you have to work underneath the vehicle, you must use suitable stands additionally to support the vehicle, there is a risk of accident!.
- Never raise the vehicle if it is tilting to one side or the engine is running.
- Never start the engine when the vehicle is raised. The vehicle may come loose from the jack due to the engine vibrations.

ⓘ NOTICE

- The vehicle must not be raised on the crossbar. Place the jack only at the support points provided on the strut and align it. Otherwise, the vehicle may be damaged.
- Any type of load or weight applied to the external trim/door will (stepped on, fitting the jack, resting heavy objects, etc.) can cause damage to it. SEAT accepts no responsibility for any damages caused by improper use of the external trim or body.

Removing and installing a wheel

Change the wheel after loosening the wheel bolts and raising the vehicle with the jack.

When removing/fitting the wheel, the rim may hit and damage the brake disc. Therefore, please take care and get a second person to assist you.

Taking off the wheel

- Unscrew the bolts with the wheel wrench and place them on a clean surface.
- Remove the wheel.

Putting on the spare wheel

Check the direction of rotation of the tyre
»» page 357.

- Place the spare wheel or temporary spare wheel into position.
- Screw in the wheel bolts and tighten them a little with the wheel wrench.
- Use the appropriate adapter to tighten the anti-theft wheel bolts.
- Carefully lower the vehicle using the jack.
- Use the wheel spanner to tighten all of the wheel nuts clockwise. Tighten the bolts in diagonal pairs (not in a circle).
- Put the caps, trim or full hubcap back on.

The wheel bolts should be clean and turn easily. Before fitting the spare wheel, inspect the wheel condition and hub mounting surfaces. These surfaces must be clean before fitting the wheel.

Tightening torque of the wheel nuts

The prescribed tightening torque for wheel bolts for steel and alloy wheels is **140 Nm**. After changing a wheel, have the tightening torque checked immediately with a torque wrench that is working perfectly.

Before checking tightening torque, have any rusty wheel bolts that are difficult to screw replaced and clean the wheel hub threads.

Never apply grease or oil to wheel bolts or to the wheel hub threads. Even if the bolts have been tightened to the prescribed torque, they could come loose while driving.

Tyres with directional tread pattern

Tyres with directional tread pattern have been designed to operate best when rotating in only one direction. An arrow on the tyre sidewall indicates the direction of rotation on tyres with directional tread. Always observe the indicated direction of rotation in order to guarantee optimum grip and help avoid aquaplaning, excessive noise and wear.

If the tyre is mounted in the opposite direction of rotation, drive with extreme caution, as the tyre is no longer being used correctly. This is of particular importance when the road surface is wet. Change the tyre as soon as possible or remount it with the correct direction of rotation.

Works after changing a wheel

- Replace the hub caps or wheel bolt caps (depending on equipment).
- Return all tools to their proper storing location.
- If the replaced wheel does not fit in the spare wheel housing, store it safely in the luggage compartment »» page 282.
- Check the tyre pressure of the newly mounted tyre as soon as possible.
- In vehicles fitted with a tyre pressure indicator, adjust the pressure and store it in memory »» page 357.

- Have the tightening torque of the wheel nuts checked as soon as possible with a torque wrench »» page 356. Meanwhile, drive carefully.
- Have the flat tyre replaced as quickly as possible.

Tyre pressure monitor system

Tyre pressure monitor indicator



Fig. 250 Instrument cluster: warning of loss of tyre pressure.

The tyre pressure monitoring system compares the individual speeds of each wheel and thus the dynamic radius with the help of the ABS sensors.

If the rolling circumference of one or more wheels has changed, the tyre pressure monitoring indicator will indicate this on the instrument

panel through a warning lamp and a warning to the driver »» **Fig. 250**. If only one tyre is affected, its position on the vehicle will be indicated.

(L) Loss of pressure: Check left tyre pressure!

Change in wheel diameter

The wheel diameter changes when:



- Tyre pressure is changed manually.
- The tyre pressure is insufficient.
- The tyre's structure is damaged.
- The vehicle is not level due to a load.
- The wheels on an axle are subject to a heavier load (e.g. with a heavy load).
- The vehicle is fitted with snow chains.
- The temporary spare wheel is fitted.
- One wheel has been changed on an axle.

There may be a delay in the reaction of the tyre pressure monitoring indicator (L) or it may not indicate anything under certain circumstances (e.g. sporty driving, snow-covered or unpaved roads, or when driving with snow chains).

Calibrate the tyre pressure monitoring indicator

After changing the tyre pressure or replacing one or more wheels, the tyre pressure monitoring indicator must be recalibrated. This should also be done, for example, when switching the front and rear tyres.

It should be calibrated with the vehicle stopped and its tyres cold. If calibrated while the tyres are hot, the pressure check and calibration procedure should be repeated when cold before the next trip.


- Switch the ignition on.
- Save the new inflation pressure in the Infotainment system: function button  >  **Vehicle info > Vehicle status >>>** page 37.
- **OR:** through the **Service** menu on the instrument cluster >>> page 31.

The tyre pressure loss indicator uses the ABS sensors to compare the turns of each wheel and, therefore, their tread circumferences, among other aspects. The set values are collected and monitored after a long journey at different speeds.

For example, if the wheels are under very heavy loads, the tyre pressure must be increased to the total recommended tyre pressure before calibration >>> **Fig. 250**.

WARNING

If the tyres are inflated to different pressures, or to a pressure that is too low, a tyre may be damaged and control of the vehicle may be lost. This could lead to a serious or even fatal accident.

- If the lamp  lights up, reduce speed immediately and avoid any sudden turning or braking manoeuvres. Stop as soon as possible, and check the pressure and status of all tyres.
- The tyre pressure loss indicator only works correctly if all the tyres are at the correct pressure when cold, and it is subsequently calibrated according to the described procedure.
- If the tyres have no punctures and do not need to be replaced immediately, drive to the nearest specialist workshop at low speed and have the tyre pressure checked and corrected.

Note

- When driving for the first time with new tyres at high speeds, the tyres may expand slightly, which may result in an air pressure warning.
- If a low tyre pressure is detected when the ignition is switched on, an audible warning will sound. If the system fails, an audible signal sounds.


- Driving on unpaved roads for a long period of time, or sporty driving, may temporarily deactivate the system. The warning lamp shows a fault, but disappears when road conditions or driving behaviour change.
- Do not only rely on the tyre pressure monitoring system. Check the tyres regularly to ensure that the tyre pressures are correct and that the tyres are free of damage such as punctures, cuts, gouges and dents. Remove any non-puncturing objects from the tyres.
- The tyre pressure monitoring indicator does not function when there is a fault in the ESC or ABS >>> page 173.

Troubleshooting

Low tyre pressure

The control lamp switches on yellow.

The inflation pressure of one or more wheels is much lower than the value set by the driver, or the tyre has structural damage. In addition, a audible warning sounds and a text message is displayed on the instrument panel screen.

-  **Stop the vehicle!** Stop the vehicle safely as soon as possible.
- Check all tyres and pressures.
- Replace any damaged tyres.

Fault in the tyre pressure loss indicator

The control lamp flashes for approximately 1 minute and then lights up permanently in yellow.

- If the tyre is inflated correctly, switch the ignition off and on again.
- Re-calibrate the tyre pressure monitoring system » page 357
- If the fault continues, go to a specialised workshop.

Tyre repair

TMS (Tyre Mobility System) puncture repair kit

The puncture repair kit (Tyre Mobility System) will reliably seal punctures caused by the penetration of a foreign body of up to about 4 mm in diameter. **Do not remove foreign objects, e.g. screws or nails, from the tyre.**

After inserting the sealant residue in the tyre, you must again check the tyre pressure about 10 minutes after starting the engine.

You should only use the tyre mobility set if the vehicle is parked in a safe place, you are familiar with the procedure and you have the necessary tyre mobility set. Otherwise, you should seek professional assistance.

Tyre sealant must not be used in the following cases:

- If the wheel rim has been damaged.
- In outside temperatures below -20°C [-4°F].
- If the cut or punctures in the tyres are larger than 4 mm.
- If the tyre has been driven on with very low inflation pressure or no tyre pressure.
- If the expiry date of the sealant bottle has passed.

WARNING

Using the puncture repair kit can be dangerous, particularly when filling the tyre on the roadside. To reduce the risk of serious injury, consider the following:

- Stop the vehicle as soon as possible in a safe place. Park it at a safe distance from road traffic to fill the tyres.
- Make sure the ground is flat and firm.
- All occupants, especially children, should stay a safe distance away from the work area.
- Turn on the hazard lights to warn other road users.
- Always stop the engine, apply the electronic parking brake and put it in gear if fitted with a manual gearbox, or press the parking lock button P if fitted with an automatic gearbox, to reduce the risk of involuntary movement of the vehicle .

- Use the puncture repair kit only if you are familiar with the necessary operations. Otherwise, you should seek professional assistance.

- The puncture repair kit should only be used in an emergency, to reach the nearest garage.

- Replace tyres repaired with the puncture kit as soon as possible.

- The sealant is harmful to health and must be cleaned off immediately if it comes into contact with the skin.

- Always keep the puncture repair kit out of the reach of children.

WARNING

A tyre filled with sealant does not have the same driving properties as a conventional tyre.

- Never drive faster than 80 km/h (50 mph).
- Avoid full throttle, braking heavily and cornering at high speeds.
- Drive for only 10 minutes at a maximum speed of 80 km/h (50 mph) and then check the tyre.

For the sake of the environment

Dispose of used or expired tyre sealant in accordance with the relevant legal requirements.

Note

You can purchase new bottles of tyre sealant from SEAT dealers.

Note

Take into account the separate instruction manual provided by the tyre mobility system manufacturer.

Anti-puncture kit contents

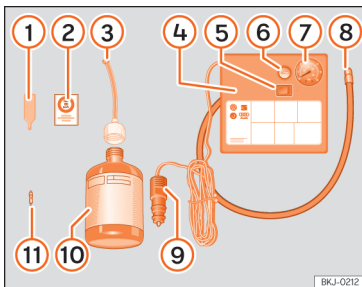


Fig. 251 Standard display: contents of the anti-puncture kit.

The anti-puncture kit is located underneath the floor covering in the luggage compartment. Includes the following components » **Fig. 251**:

- ① Valve insert remover

- ② A sticker to be adhered to the instrument cluster, within the driver's visual field, to remind that the maximum advisable speed "max. 80 km/h" or "max. 50 mph"
- ③ Filler tube with cap
- ④ Air compressor (depending on the version, the model may vary).
- ⑤ ON/OFF switch
- ⑥ Air bleed screw (it can also be integrated in the inflator tube).
- ⑦ Warning provided by tyre pressure monitoring system (it can also be integrated in the inflator tube).
- ⑧ Tube for inflating tyres
- ⑨ 12 volt connector
- ⑩ Bottle of sealant
- ⑪ Spare tyre valve

The **valve insert remover** ① has a gap at the lower end for a valve insert. The valve insert can only be screwed or unscrewed in this way. This also applies to its replacement part ⑪.

Sealing and inflating a tyre

Sealing the tyre

- Unscrew the tyre valve cap and insert. Use the device » **Fig. 251** ① to remove the valve cap. Place it on a clean surface.
- Shake the tyre sealant bottle vigorously » **Fig. 251** ⑩.

- Screw the tyre inflation hose » **Fig. 251** ③ into the tyre sealant bottle. The bottle's seal will break automatically.
- Remove the filler cap » **Fig. 251** ③ and screw the open end of the tube into the tyre valve.
- With the bottle upside down, empty **all** of the contents into the tyre.
- Remove the bottle from the valve.
- Replace the howitzer with the device » **Fig. 251** ① onto the tyre valve.

Inflating the tyre

- Screw the tyre inflation tube of the compressor » **Fig. 251** ⑧ on the tyre valve.
- Check that the air evacuation screw is closed » **Fig. 251** ⑥.
- Start the engine and leave it running.
- Attach the connector » **Fig. 251** ⑨ to the vehicle's 12 volt power outlet » **page 232**.
- Switch on the air compressor with ON/OFF switch » **Fig. 251** ⑤.
- Keep the air compressor running until it reaches a pressure of 2.0-2.5 bar [29-36 psi/ 200-250 kPa]. **A maximum of 8 minutes.**
- Disconnect the air compressor.
- If it does not reach the pressure indicated, unscrew the tyre inflator tube from the valve.
- Move the vehicle 10m so that the sealant is distributed throughout the tyre.

- Screw the compressor tyre inflator into the valve.
- Repeat the inflation process.
- If it still does not come up to pressure, the tyre is too badly damaged. Stop and seek assistance from authorised personnel.
- Disconnect the air compressor. Unscrew the tyre inflation tube from the tyre valve.
- When the tyre pressure is between 2.5 and 2.0 bars, continue driving without exceeding 80 km/h (50 mph).
- Attach the sticker >>> Fig. 251 ② to the instrument panel display, within the driver's field of vision.
- Check the pressure again after 10 minutes >>> page 361.

WARNING

When inflating the wheel, the air compressor and the inflator tube may become hot.

- Protect hands and skin from hot parts.
- Do not place the hot flexible inflator tube or hot air compressor on flammable material.
- Allow them to cool before storing the device.
- If it is not possible to inflate the tyre to at least 2.0 bars (29 psi / 200 kPa), the tyre is too badly damaged. The sealant is not in a good condition to seal the tyre. Do not continue driving. Seek specialist assistance.


NOTICE

Switch off the air compressor after a maximum of 8 operational minutes to avoid overheating! Before switching on the air compressor again, let it cool for several minutes.

Check after 10 minutes of driving

Screw in the inflator tube >>> Fig. 251 ⑧ again and check the pressure on the gauge ⑦.

1.3 bar (19 psi / 130 kPa) and lower:

- **Stop the vehicle!** The tyre cannot be sealed sufficiently with the tyre mobility set.
- You should obtain professional assistance >>> .

1.4 bar (20 psi/140 kPa) and higher:

- Set the tyre pressure to the correct value again.
- Carefully resume your journey until you reach the nearest specialised workshop without exceeding 80 km/h (50 mph).
- Have the damaged tyre replaced.

WARNING

Driving with an unsealed tyre is dangerous and can cause accidents and serious injury.

- Do not continue driving if the tyre pressure is 1.3 bar (19 psi / 130 kPa) and lower.
- Seek specialist assistance.

Maintenance

Service

Service work and the Digital Maintenance Plan

Log of services performed (“Digital Maintenance Plan”)

The SEAT dealership or a specialised workshop records Service receipts in a central system. Thanks to this comprehensive documentation of the service history, it is possible to reproduce the services performed any time. SEAT recommends requesting a Service receipt after every service carried out containing all the services carried out on the system.

Whenever there is a new service the receipt is replaced with a current one.

The Digital Maintenance Plan is not available in some markets. In this case, your SEAT dealer will inform you about the current documentation of the work.

Service works

In the Digital Maintenance Plan, your SEAT authorised service or specialised workshop documents the following information:

- When each one of the services was carried out.
- Whether a specific repair has been suggested, e.g. changing the brake pads in the near future.
- If you have expressed a special request for the maintenance. Your Service Advisor will write the work order.
- The components or fluids that were changed.
- The date of the next service.

The Long Life Mobility Warranty is valid until the next inspection. This information is documented in all checks performed.

The type and the volume of the service may vary from one vehicle to another. A specialised workshop will be able to provide specific information on the jobs for your vehicle.

WARNING

If the services are insufficient or not performed and if the service intervals are not observed, the vehicle may be immobilised in traffic cause an accident and severe injuries.

- **Make sure that any repairs are carried out by a SEAT authorised service or specialised workshop.**

NOTICE

SEAT cannot be held liable for any damage to the vehicle due to insufficient work or of lack of availability of spare parts.

Note

Regular services on the vehicle not only maintain its value, but also its correct operation and road safety. For this reason, conduct the services in accordance with SEAT guidelines.

Set Service or Flexible Service Intervals

Services are classified as **oil change service** and **inspection**. The service interval display on the instrument panel display serves as a reminder of the next service.

Depending on the features, the engine and the conditions of use of the car, either the **Fixed service** or the **Flexible service** will be applied for an oil change service..

How to know which type of service needs to his vehicle

Check the tables below:

Oil change service ^{a)}		
PR No.	Type of service	Service interval
Q11	Fixed	Every 5000 km or after 1 year^{b)}
Q12		Every 7500 km or after 1 year^{b)}
Q13		Every 10000 km or after 1 year^{b)}
Q14		Every 15000 km or after 1 year^{b)}
Q16	Flexible	According to the service interval display.

^{a)} The data are based on normal conditions of use.

^{b)} Whatever happens first.

Inspection Service^{a)}

According to the service interval display.

^{a)} The data are based on normal conditions of use.

Particular characteristics of the Flexible Service



Regarding the **Flexible Service** the oil change service only has to be performed when the vehicle needs it. To calculate when you have to carry out this service, take into account the individual conditions of use and personal driving

style. A major component of the flexible service is the use of LongLife oil instead of conventional engine oil.

Bear in mind the information about the specifications of the engine oil according to the VW standard »» page 334.

If you do not want to the flexible service you can select the fixed service. However, a fixed service may affect service costs. The Service Advisor will gladly advise you.

At SEAT, the dates of the services are indicated by the service intervals display:

- on the instrument panel »» page 31
- in the infotainment system: menu  > **Settings > Service: OR**  > **Vehicle status > Service** »» page 37.

The service interval display gives information for service dates that involve an engine oil change or an inspection. When the time for the corresponding service comes, additional work required, such as the change of brake fluid and the spark plugs, can be carried out.

Information about the terms of use

The service intervals and groups are usually based on **normal conditions of use**.

If, on the other hand, the vehicle is under **adverse conditions of use**, some of the work must be carried out before the next service period or even between service intervals.

Conditions of use adverse include:

- The use of fuel with a high sulphur content.
- Frequent short trips.
- Letting the engine idle for a long period of time, as in the case of taxis.
- Using the vehicle in areas with thick dust.
- Frequent driving with a trailer (depending on equipment).
- Using the vehicle mostly in situations with a lot of traffic and stops (e.g. in the city).
- Using the vehicle mostly in winter.

This applies especially for the following parts (depending on equipment):

- Dust and pollen filter
- Air Care allergen filter
- Air filter
- Toothed chain
- Particulate filter
- Engine oil

The Service Advisor of your specialised workshop will gladly inform you about the need of performing service work between normal service intervals, always considering the conditions of use of your vehicle.

⚠ WARNING

If the services are insufficient or not performed and if the service intervals are not observed, the vehicle may be immobilised in traffic and cause accidents and severe injuries.

- Have the services conducted at authorised SEAT services or specialised workshops.

ⓘ NOTICE

SEAT cannot be held liable for any damage to the vehicle due to insufficient work or of lack of availability of spare parts.

Service sets

Sets of services include all the **maintenance works** needed to ensure the safety and the smooth running of the vehicle (**depending on the conditions of use and the features of the vehicle**, such as the engine, gearbox, or operating fluids).

Maintenance services are divided into *inspection and review* services. Consult the details of the jobs required for your vehicle at:

- Your SEAT authorised service
- Your specialised workshop

Due to technical reasons (continuous development of components) the sets of services may vary. Your SEAT authorised service or specialised workshop is always receiving updates in time.

Additional service offers**Approved spare parts**

Original SEAT Spare Parts have been conceived for their vehicles and approved by SEAT, with a special emphasis on safety. These parts correspond exactly to the manufacturer's requirements in terms of design, accuracy of the measurements and materials. The original SEAT Spare Parts have been conceived exclusively for your vehicle. For this reason, we always recommend the use of Original SEAT Spare Parts. SEAT cannot be held liable for the safety and suitability of parts from other manufacturers.

Approved spare parts

Approved spare parts, following the manufacturer's requirements, are an additional service to you, offering the possibility of replacing complete sets, such as: light engine, gearboxes, heads, control units, electrical components, etc.

These parts are, **approved parts**, and are the same as the factory parts, which are also approved spare parts.

Original accessories

We recommend you only use SEAT Original Accessories and SEAT approved accessories for your vehicle. The reliability, safety and suitability of these accessories have been inspected specifically for this type of vehicle. SEAT cannot be held liable for the safety and suitability of parts from other manufacturers.

Service Mobility

As of the moment you purchase your SEAT vehicle you will be able to enjoy the benefits and coverage of Service Mobility.

For the first two years after the purchase, your new SEAT vehicle is automatically covered by Service Mobility at no additional cost.

If you wish to enjoy this service after this period, you can extend SEAT Service Mobility as long as you carry out the recommended Inspection and Maintenance Services at a SEAT Authorised Service.

If your SEAT vehicle is immobilised due to a fault or an accident, our assistance services will help you keep moving.

Take into account that the SEAT Mobility Service differs depending on the country in which the vehicle was purchased. For further information ask your SEAT dealership or the SEAT website in your country.

Vehicle upkeep and cleaning

Basic observations

Regular and careful care helps to maintain the value of your vehicle. In addition, it may become a prerequisite to demand the warranty in the event of corrosion damage and deficiencies in the paint coat of the bodywork.

Specialised workshops have the necessary care products. Please follow the instructions for application on the packaging.

WARNING

- Cleaning products and other materials used for car care can be damaging to your health if misused.
- Always keep care products in a safe place, out of the reach of children. Danger of poisoning!

For the sake of the environment

- When purchasing car care products, choose products that are compatible with the environment.
- The waste from car-care products should not be disposed of with ordinary household waste.

Washing the vehicle

The longer you take to clean the tanks, e.g. remains of insects, bird excrements, tree resin or anti frost salt adhered to your vehicle, the more damage it can cause to the surface. High temperatures, for instance strong sunlight, further intensify the damage.

Before washing the car, soften the dirt using plenty of water.

To remove encrusted dirt such as insects, bird droppings or tree resin, use a lot of water and a microfibre cloth.

Have the underside of the vehicle washed after the end of the anti frost salts in winter.

High pressure cleaning equipment

When washing the vehicle with a high-pressure cleaner, always follow the operating instructions for the equipment. This applies particularly to the operating pressure and the distance between the spraying water.

Do not aim the jet directly towards the side windows, doors, sunroof or covers; the same applies for the tyres, rubber hoses, damping material, sensors or camera lenses. Keep a distance of at least 40 cm.

Do not remove snow and ice with a high-pressure cleaner.

Do not use a nozzle that sprays the water out in a direct stream or one that has a rotating jet for forcing off dirt.

The water temperature must not exceed 60°C.

Automatic car washes

Spray the vehicle before starting the car wash.

Make sure that the windows and sunroof are closed and the wipers are deactivated. Bear in mind the instructions of the car wash tunnel operator, especially if your vehicle has detachable parts.

Use of car washes without brushes if possible.

Washing by hand

Clean your vehicle from top to bottom with a soft sponge or with a brush. Only use cleaning products that do not contain solvents.

Polishing

Polishing is only necessary when the vehicle's paintwork has lost its gloss and cannot be restored with care products.

Do not polish matt painted surfaces! If the paintwork is polished, the surface will be irreparably damaged.

Washing vehicles with matte paintwork

To wash the vehicle, it is best to use a special cleaner for matte paintwork. For further information, please contact an official service centre.

Apply the product by spraying it onto the body-work. Work in one zone at a time and leave the product to act for at least 2 minutes. Wipe it with a microfibre cloth and **avoid placing excessive pressure** on the treated area until the dirt is removed. Once clean, repeat the application of the product area by area and spread it until a uniform finish is achieved.

If the vehicle is affected by mosquitoes or larger amounts of dirt, spray the product on the entire surface, leave it to act for 2 minutes and apply pressurised water until it is completely clean. Once dry, apply the product one zone at a time and spread it with microfibre, **avoiding excessive pressure**, to achieve a uniform finish.

In both cases, the final application cares for the vehicle in an optimal manner and provides a protective layer against dirt and water.

WARNING

- Only wash the vehicle with the ignition switched off or according to the specifications of the car wash tunnel operator. Accident hazard!
- When cleaning the underbody or the inside of the wheel arches, protect yourself from sharp or pointy metal parts. Risk of cuts!

- After cleaning the brakes could act more slowly due to moisture or, in winter, the ice on the brake discs and pads. Accident hazard! In this case the brakes should be dried by pressing the brake pedal several times.

WARNING

Incorrect use of high-pressure cleaning equipment can cause damage. This can lead to accidents and serious injuries.

- Never direct the jet of the high-pressure cleaning equipment directly at the orange high-voltage cables, the high-voltage system components or the 12-volt on-board network.

NOTICE

- Before washing the vehicle in an automatic car wash, the exterior mirrors should be folded in to prevent them from being damaged. The electric folding exterior mirrors should only be folded or unfolded electrically!
- Do not wash the vehicle in direct sunlight. Risk of damaging the paint job!
- Do not use sponges, abrasive household sponges or similar to clean insect remains. Risk of damaging the surface!

- Vehicle parts with matte paint:

- Do not use polish or hard wax. Risk of damaging the surface!
- Never select washing programmes that include the use of wax. This could damage the appearance of matte paint.
- Do not put stickers or magnets on parts with matte paint, as removing them may damage the paint.

For the sake of the environment

The car should only be washed in special wash bays. These places are prepared to prevent oily water from getting into the public drains.

Cleaning the exterior

Below can be found some recommendations on the cleaning and upkeep of individual vehicle components.

Go to your specialised workshop if you have special questions or parts that are not listed.

Take the general considerations into account
 >>> page 368, *Take special care with...*

Windscreen wipers

- Dirt: Soft cloth with windscreen cleaner.

Headlights / Tail lights

- *Dirt*: Soft sponge with neutral soap solution¹⁾.

Sensors / Camera lenses

- *Dirt*:
 - *Sensors*: soft cloth with a solvent-free cleaning product.
 - *Camera lenses*: soft cloth with an alcohol-free cleaning product.
- *Snow/ice*: Hand brush/Solvent-free antifreeze spray

Wheels

- *Antifreeze salt*: Water.
- *Brake abrasion dust*: Special acid-free cleaning product.

End exhausts

- *Antifreeze salt*: Water, if a fine steel cleaning product is required, or a non-abrasive and non-corrosive cleaning product.

Covers / Trims

- *Dirt*: Neutral soap solution¹⁾, if a fine steel cleaning product is required.

Paint

- *Paint flaws*: Check the paint's colour code at an authorised service and restore with a touch-up pencil.
- *Spilled fuel*: Immediately rinse with water.
- *Tank with environmental rust*: Apply rust remover and then apply hard wax. Go to your specialised workshop if you have any queries.
- *Corrosion*: Have your specialised workshop take care of this.
- *Water does not form droplets on the clean paint*: Maintain with hard wax (at least twice a year).
- *No shine despite maintenance/unattractive paint*: Treat with suitable wax and apply paint preservative afterwards if the wax used does not contain preservative ingredients.
- *Tanks, e.g. insect remains, bird droppings, tree sap, road salt*: Immediately soak with water and remove with a microfibre cloth.
- *Grease-based dirt, e.g. cosmetic products or sunscreen*: Remove immediately with a neutral soap solution¹⁾ and a soft cloth.

Carbon fibre parts

- *Dirt*: Clean in the same way as painted parts
»» page 365.

Decoration slides

- *Dirt*: Soft sponge with neutral soap solution¹⁾.

Interior cleaning

Below can be found some recommendations on the cleaning and upkeep of individual vehicle components.

Go to your specialised workshop if you have special questions or parts that are not listed.

Take the general considerations into account
»» page 368, *Take special care with...*

Windows

- *Dirt*: Apply windscreen cleaner and then dry with a cloth.

Covers / Trims

- *Dirt*: Neutral soap solution¹⁾.

Plastic parts

- *Dirt*: Damp cloth.
- *Encrusted dirt*: Neutral soap solution¹⁾, if possible a solvent-free plastic cleaning product.

Displays/instrument panel

- *Dirt*: Soft cloth with a liquid crystal display cleaner.

¹⁾ Neutral soap solution: maximum of two tablespoons in 1 l of water.

Control panels

- *Dirt*: Soft brush, then a soft cloth with a neutral soap solution¹⁾.

Seat belts

- *Dirt*: Neutral soap solution¹⁾, allowed to dry before retracting.

Fabrics, artificial, Alcantara leather

- *Particles of dirt stuck to surfaces*: Vacuum cleaner.
- *Water-based dirt, e.g. coffee, tea, blood etc.*: Absorbent cloth and neutral soap solution¹⁾.
- *Grease-based dirt, e.g. oil, make-up, etc.*: Apply a neutral soap solution¹⁾. Absorb the dissolved grease and paint particles drying with an absorbent cloth, in case you must treat it with water afterwards.
- *Special dirt, e.g. pens, nail polish, dispersion paint, shoe polish, etc.*: Special stain remove: dry with an absorbent cloth, if applicable, apply neutral soap solution afterwards¹⁾.

Natural leather

- *Recent dirt*: Cotton cloth with neutral soap solution¹⁾.

- *Water-based dirt, e.g. coffee, tea, blood etc.*:
 - *Recent stains*: absorbent cloth.
 - *Dry stains*: stain remover suitable for leather.
- *Grease-based dirt, e.g. oil, make-up, etc.*:
 - *Recent stains*: absorbent cloth and suitable stain remover for leather.
 - *Dry stains*: grease solvent spray.
- *Special dirt, e.g. pens, nail polish, dispersion paint, shoe cream etc.*: Stain remover suitable for leather.
- *Care*: Apply preservative cream regularly to protect from sunlight. Use a coloured preservative if required.

Carbon fibre parts

- *Dirt*: Clean as with plastic parts.

Take special care with...

Headlights/tail lights

- Do not clean the headlights/tail lights with a dry cloth or sponge.
- Do not use cleaning products that contain alcohol. Risk of cracks!

Wheels

- Do not use for paint wax or other abrasive products.
- If the protective coating on the paint of the rim has been damaged due to stone impacts, scratches, etc., the damage should be repaired immediately.

Camera lenses

- Do not use hot or warm water to remove ice or snow from the camera lenses. Risk of cracking the lens!
- To clean the camera lens, never use abrasive cleaning products or products with alcohol. Risk of scratches and cracks!

Windows

- Remove snow and ice from windows and exterior mirrors with a plastic scraper only. To avoid scratches, the scraper should only be pushed in one direction and not moved to and fro.
- Never remove snow or ice from windows and rearview mirrors with warm or hot water. Risk of cracks on the windows!
- To prevent damage to the heating of the rear window, do not put stickers over the heating elements.

¹⁾ Neutral soap solution: maximum of two tablespoons in 1 l of water.

Covers/trims

- Do not use cleaning products or chrome based cleaning agents.

Paint

- The vehicle must be free from dirt and dust before applying wax or care products. Risk of scratches!
- Do not apply wax or care products if the vehicle is exposed to direct sunlight. Risk of damaging the paint job!
- The ambient rust deposits must not be removed through friction. Risk of damaging the paint job!
- Remove cosmetic products and sunlight immediately. Risk of damaging the paint job!

Displays/instrument panel

- The displays, the instrument panel and the trim around it must not be cleaned dry. Risk of scratches!
- Make sure that the instrument panel is switched off and cooled down before cleaning.
- Make sure that no liquid leaks between the instrument panel and the trim. Risk of damage!

Control panels

- Make sure that no liquid leaks into the control panels. Risk of damage!

Seat belts

- Do not remove the seat belts to clean them.
- Seat belts and their components must never be cleaned with chemical products, nor should they be allowed to come into contact with corrosive liquids, solvents or sharp objects. Risk of damaging the fabric!
- If you find any damage to the belt webbing, belt fittings, the belt retractor or the buckle, ask your specialised workshop to replace the belt in question.

Fabrics/artificial leather/microfibre

- Do not treat artificial leather/microfibre with leather cleaning products, solvents, wax polish, shoe cream, stain removers or similar products.
- If the stain is very hard to remove, take the vehicle to a specialised workshop to have it removed there. This will prevent damage.
- Do not use steam cleaners, brushes, hard sponges, etc. to clean.
- Do not turn on seat heating to dry the seats.
- Sharp objects on clothing, such as zips, rivets or belts can damage the surface.
- Open Velcro, e.g. on clothes can damage the seat upholstery. Make sure that Velcro fasteners are closed.

Natural leather

- Never use solvents, wax polish, shoe cream, spot removers or similar products on leather.
- Sharp objects on clothing, such as zips, rivets or belts can damage the surface.
- Do not use steam cleaners, brushes, hard sponges, etc. to clean.
- Do not turn on seat heating to dry the seats.
- Avoid exposing leather to direct sunlight for long periods, otherwise it may tend to lose some of its colour. If the car is left for a prolonged period in the bright sun, it is best to cover the leather.

WARNING

Do not use water-repellent coatings on the windscreen. In bad visibility conditions such as humid weather, darkness or when the sun is in its lowest point, visibility may be impacted. Accident hazard! Such coatings can also cause the windscreen wiper blades to make noise.

Note

- Remains of insects can be removed much more easily with previously treated paint.
- Regular car care treatments can prevent deposits of ambient rust.

Remove the vehicle from traffic

If you want to leave your vehicle stationary for a long period of time, contact a qualified workshop. They will gladly inform you about the necessary measures, such as anti-corrosion protection, Service and storage.

Also take into account the indications relating to the vehicle's battery »» page 337 , »» page 337, *Introduction*.

Accessories, spare parts and repair work

Introduction

Always ask your dealer or specialist retailer for advice before purchasing accessories and replacement parts.

Your vehicle is designed to offer a high standard of active and passive safety. For this reason, we recommend that you ask a SEAT Official Service for advice before fitting accessories or replacement parts. Your SEAT Official Service has the latest information from the manufacturer and can recommend accessories and replacement parts which are suitable for your requirements. They can also answer any questions you might have regarding official regulations.

We recommend only using **SEAT accessories** and **genuine SEAT parts**®. SEAT has tested these parts and accessories for suitability, reli-

ability and safety. SEAT Official Services have the necessary experience and facilities to ensure that the parts are installed correctly and professionally.

Although SEAT continuously monitors the market, it cannot judge whether products **not authorised by SEAT** meet the vehicle's reliability, safety and suitability requirements. SEAT therefore accepts no liability for these products, even if, in certain cases, they are authorised by an officially recognised technical inspection institute or official body.

Any **retro-fitted equipment** which has a direct effect on the vehicle and/or the way it is driven, such as a cruise control system **or electronically-controlled suspension**, must be approved for use in your vehicle and bear the **e** mark (the European Union's authorisation symbol).

If **any additional electrical devices** are fitted which do not serve to control the vehicle itself (for instance a refrigerator box, laptop or ventilator fan, etc.), they must bear the **CE** marking (manufacturer conformity declaration in the European Union).

WARNING

Accessories, for example telephone holders or cup holders, should never be fitted on the covers, or within the working range of the airbags. Otherwise, there is a danger of injury if the airbag is triggered in an accident.

Technical modifications

Unauthorised modifications to the electronic components, software, wiring or data transfer in the vehicle may cause malfunctioning.

You will appreciate that your SEAT dealership cannot be held liable for any damage caused by modifications and/or work performed incorrectly.

For this reason we recommend asking official SEAT service centres to do any necessary work using **genuine SEAT parts**®.

WARNING

Incorrectly performed modifications or other work on your vehicle can lead to malfunctions and cause accidents.

Radio telephones and office equipment

Radio transmitters (fixed installation)

Any retrofit installations of radio transmitters in the vehicle require prior approval. SEAT generally authorises in-vehicle installations of approved types of radio transmitters provided that:


- The antenna is installed correctly.
- The aerial is installed on the exterior of the vehicle (and shielded cables are used together with non-reflective aerial trimming).
- The effective transmitting power does not exceed 10 Watts at the aerial base.

A SEAT Official Service and specialised workshop will be able to inform you about options for installing and operating radio transmitters with a higher transmitting power.

Mobile radio transmitters

Commercial mobile telephones or radio equipment might interfere with the electronics of your vehicle and cause malfunctions. This may be due to:

- No external aerial.
- External aerial incorrectly installed.
- Transmitting power more than 10 W.

You must, therefore, do not operate portable mobile telephones or radio equipment *inside the vehicle* without a properly installed external aerial »» .

Please note also that the maximum range of the equipment can only be achieved with an *external* aerial.

Business equipment

Retrofit installation of business or private equipment in the vehicle is permitted, provided the equipment cannot interfere with the driver's im-

mediate control of the vehicle and that any such equipment carries the **CE** mark. Any retrofit equipment that could influence the driver's control of the vehicle must have a type approval for your vehicle and must carry the **e** mark.

WARNING

Mobile telephones or radio equipment which is operated inside the vehicle without a properly installed external aerial can create excessive magnetic fields that could cause a health hazard.

Note

- **The posterior fitting of electric and electronic equipment in this vehicle affects its licence and could lead to the withdrawal of the vehicle registration document under certain circumstances.**
- **Please use the mobile telephone/radio operating instructions.**

Information for the user

Warranty

Fault-free operation warranty

SEAT Authorised Services ensure the perfect condition of new vehicles. Check the purchase agreement or complementary additional documentation provided by your Technical Service to see the conditions and the terms of the warranty. Consult further information in this regard in your SEAT Official Service.

Commercial warranty for high voltage batteries for electric and hybrid vehicles

To supplement the aforementioned warranties and guarantees, SEAT Official Services also grant a guarantee for high voltage batteries existing in many countries.

Consult the details of this guarantee in the sales contract or contact a SEAT Official Service.

Information stored by the control units

Storage of accident data (Event Data Recorder)

Your vehicle has an event data recorder (EDR). The EDR's function is to record data in the event of a mild or serious accident. These data are used to support the analysis of how different vehicle systems behaved.

The EDR records, over a reduced time range (normally 10 seconds or less), dynamic driving data and data from the restraint systems, such as:

- How different vehicle systems worked.
- Whether the driver and the occupants were wearing their seat belts.
- How hard the acceleration or brake pedal was pressed.
- Vehicle speed.
- GPS position.

These data will provide a better understanding of the circumstances of the accident.

Data from the driving assist systems are also recorded. This includes data such as whether the systems were inactive or active and if such action had an impact on the vehicle's dynamic

behaviour, changing its path in the aforementioned situations, accelerating or decelerating the vehicle.

Depending on vehicle equipment, this includes data from systems such as:

- the adaptive cruise control
- the lane assist system
- parking assistants
- the emergency brake functions.

The EDR data are only recorded in specific accident situations. No data are recorded in normal driving conditions.

No audio or video data inside or around the vehicle are recorded. Under no circumstances are personal data such as name, age, or gender recorded. Nevertheless, third parties (such as criminal proceedings authorities) may relate the contents of the EDR data to other data sources and create a personal reference in the context of an accident investigation.

In order to read the EDR data it is necessary to access (if legally permitted to do so) the vehicle's ODB ("On-Board-Diagnose") interface while the vehicle is switched on.

SEAT will not have access to EDR data unless the owner (or, in "Leasing" cases, the lessee or hirer) gives their consent. There may be exceptions to this, depending on legal or contractual provisions.

Due to legal requirements in safety-related products, SEAT may use the EDR data for field research and in order to improve vehicle system quality. Any data used for the purposes of research will be treated anonymously (in other words, no reference will be made to the vehicle, their owner or the lessee/hirer).

Vehicle antennas

Infotainment system and antennas

The infotainment system's antennas are installed on different locations on the vehicle:

- On the roof.
- On the windscreen, between the layers of glass.
- On the rear and side windows with a printed antenna structure »» ⓘ.

ⓘ NOTICE

The printed antenna structure on the rear and side windows can be damaged by objects rubbing against it or by the use of corrosive products, or products containing acids.

- **Do not apply any stickers to the rear and side window areas.**
- **Never clean the antenna structure with corrosive or acidic products.**

Information on the EU chemicals regulation REACH

In accordance with the European Chemicals Regulation REACH, SEAT, S.A. has information on the substances that may be contained in the vehicle.

You can ask any SEAT dealer for this information.

Materials and recycling information

Environmental compatibility

Environmental protection is a top priority in the design, choice of materials and manufacture of your new SEAT.

Constructive measures to encourage recycling

- Joints and connections designed for easy dismantling.
- Modular construction to facilitate dismantling.
- Increased use of single-grade materials.
- Plastic parts and elastomers are marked in accordance with ISO 1043, ISO 11469 and ISO 1629.

Choice of materials

- Use of recycled materials.
- Use of compatible plastics in the same part if its components are not easily separated.
- Use of recycled materials and/or materials originating from renewable sources.
- Reduction of volatile components, including odour, in plastic materials.
- Use of CFC-free coolants.

Ban on heavy metals, with the exceptions dictated by law (Annex II of ELV Directive 2000/53/EC): cadmium, lead, mercury, hexavalent chromium.

Manufacturing methods

- Reduction of the quantity of thinner in the protective wax for cavities.
- Use of plastic film as protection during vehicle transport.
- Use of solvent-free stickers.
- Use of CFC-free coolants in cooling systems.
- Recycling and energy recovery from residues (RDF).
- Improvement in the quality of waste water.
- Use of systems for the recovery of residual heat (thermal recovery, enthalpy wheels, etc.).
- The use of water-soluble paints.

Recycling of electrical or electronic devices

All electrical or electronic devices (EED) that are not permanently fitted in the vehicle must be marked with the following symbol:



This symbol indicates that EED must not be discarded as home waste but through selective waste collection.

Product recycling

✓ Valid for market: France



Please note the recycling instructions in >>> **Fig. 252** for the following items:

- Vehicle keys
- Remote control of auxiliary heating and ventilation.

- Compressor.
- Charging cable.
- Mobile key card.



Fig. 253 Fire extinguisher recycling notice for France.

Please note the recycling instructions in >>> **Fig. 253** for the following items:

- Extinguishers.



Fig. 254 Recycling notice for France.

Please observe the recycling instructions >>> **Fig. 254** for documentation and packaging or bags of the following items:

- Maintenance manual.
- First aid kit.

- Extinguishers.
- Compressor.
- Charging cable.
- Charging socket and watertight seal.
- Vehicle toolbox.
- Puncture repair spray.
- Jack.
- Warning triangle.
- High visibility jacket.
- Tool bag.



For the sake of the environment

The Triman logo and the Info-tri symbol contain important classification information for the end user.

Product recycling

✓ Valid for market: Italy

Environmental labelling

Legislative decree no. 116 (3 September 2020), which transposes EU Directive 2018/851 on waste, and EU Directive 2018/852 on packaging and packaging waste, states that all packaging must be properly labelled to facilitate the collection, reuse, recovery and recycling of packaging, and to give users correct information about the final destination of the packaging.

Information about the environmental labelling of packaging present in the vehicle can be accessed by scanning the following QR code, which links to a website where the information required by this regulation can be found:



Return and scrapping of end-of-life vehicles

End-of-life return

At the end of its useful life, your vehicle must be recycled and disposed of in an environmentally sound manner. For this reason, final vehicle owners in the EU and in many other countries are required by law to take their vehicle to an authorised collection point, vehicle return centre or authorised dismantling facility.

SEAT already made the necessary arrangements for this: an extensive network of vehicle return centres is available throughout the EU and in many other countries, where you can drop off your vehicle. If you meet the national legal requirements, you can return your end-of-life vehicle free of charge within the EU.

The vehicle return centre issues a recycling certificate which serves as proof that the end-of-life vehicle has been recycled correctly.

Information about the Vehicle Return Centres can be obtained from your SEAT dealer.

Scrapping

The relevant safety requirements must be observed when scrapping the vehicle or its individual components, e.g. airbag system and seatbelt tensioners. Qualified workshops are already familiar with these requirements. SEAT recommends using a SEAT dealer.

Declaration of conformity

Commercialisation of finished products on the British market (England, Wales and Scotland):



The UKCA (UK Conformity Assessed) marking is a new British marking used for products commercialised in Great Britain (England, Wales and Scotland).

Importer:

Volkswagen Group United Kingdom Ltd.
Yeomans Drive, Blakelands
Milton Keynes, MK 14 5AN
United Kingdom

Vehicles commercialised on the British market by the importer mentioned above may include complete products that comply with the following provisions:

- The Electromagnetic Compatibility Regulations, 2016
- The Electrical Equipment (Safety) Regulations, 2016
- The Supply of Machinery (Safety) (Amendment) Regulations, 2011
- The Noise Emission in the Environment by Equipment for use Outdoors Regulations, 2001
- The Restriction of the Use of Certain Hazardous Substances in Electrical and Electronic Equipment Regulations, 2012
- The Medical Devices Regulations, 2002 (SISI 2002, no. 618, in its amended version) (UK MDR 2002)
- The Pressure Equipment (Safety) Regulations, 2016
- The Personal Protective Equipment (Enforcement) Regulations, 2018

Note

For medical devices, the CE marking will remain valid in the UK until 30 June, 2023.

In accordance with the aforementioned regulations, the importer has ensured that:

The manufacturer has performed the corresponding conformity assessment, has drawn up the technical documentation and meets the market requirements.

Note

Until 31 December 2025, the British market may be placed on a label that is affixed to the product or the attached documentation.

Radioelectrical equipment

Simplified declaration of conformity

Your vehicle has different radioelectrical devices. The manufacturers of these devices declare that they comply with Directive 2014/53/EU when legally required.

The full text of the EU compliance declaration is available online at the following address:

www.seat.com/generalinfo



United Kingdom

Your vehicle has different radioelectrical devices. The manufacturers of these devices declare that they comply with the UK Radio Equipment Regulations 2017 (SI 2017/1206) if required by law.

The full text of the declaration of conformity is available online at the following Internet address:

www.seat.com/generalinfo



Ukraine

Your vehicle has different radioelectrical devices. The manufacturers of these devices declare that they comply with Ukraine Decree 355/2017 (TR Radio Equipment) where legally required.

The full text of the declaration of conformity is available online at the following Internet address:

www.seat.com/generalinfo



Addresses of the manufacturers

The address of the manufacturers of components that, due to their size or nature, cannot include a sticker are listed below, as long as it is legally required:

Central control unit (BCM)

Robert Bosch GmbH/Braunschweig
Theodor-Heuss-Strasse 12
38122 - Braunschweig, Germany
Phone: 0049 53188890

Keyless Access system and key with radio remote control of the central locking system

HELLA GmbH & Co. KGaA/Hamm
Roemerstr. 66
59075 - Hamm, Germany
Phone: 0049 23817980

Roof antenna

ASK Industries S.p.A
Via dell'Industria n.12/14/16
60037 Monte San Vito (AN), Italy
Phone: +3907174521
Website: www.askgroup.it

Mitsumi Electronics Europe GmbH
Siemensstrasse 32
63225 Langen, Germany
Phone: +49 (0) 6103913-0
Website: www.minebeamitsumi.co.jp

Molex CVS Hildesheim GmbH
Daimlerring 31
31135 Hildesheim, Germany
Phone: +49 3377 3160
Website: www.molex.com

Antenna amplifiers

ASK Industries S.p.A
Via dell'Industria n.12/14/16
60037 Monte San Vito (AN), Italy
Phone: +3907174521
Website: www.askgroup.it

Hirschmann Car Communication GmbH
Stuttgarter Strasse 45-51
72654 Neckartenzlingen, Germany
Phone: +49 7127 140
Website: www.te.com

KATHREIN Automotive GmbH
Römerring 1
31137 Hildesheim, Germany
Phone: +49,031,184-0
Website: www.kathrein.com

Molex CVS Hildesheim GmbH
Daimlerring 31
31135 Hildesheim, Germany
Phone: +49 3377 3160
Website: www.molex.com

Navigation antenna

Hirschmann Car Communication GmbH
Stuttgarter Strasse 45-51
72654 Neckartenzlingen, Germany
Phone: +49 7127 140
Website: www.te.com

KATHREIN Automotive GmbH
Römerring 1
31137 Hildesheim, Germany
Phone: +49,031,184-0
Website: www.kathrein.com

Connectivity Box

Molex CVS Dabendorf GmbH
Märkische Strasse 72
15806 Zossen OT Dabendorf, Germany
Phone:+49 3377 3160
Website: www.molex.com

Molex Technologies GmbH
Mizarstraße 3, 12529 Schönefeld
Website: www.molex.com

Strona główna - BURY
ul. Wojska Polskiego 4
39-300 Mielec, Polska
info@bury.com
+48 17 78846-00

Basic infotainment system

Panasonic Automotive Systems Czech
U Panasonicu 266
530 06, Pardubice, Czech Republic

Optional infotainment system

LG Electronics Mława SP
LG Electronics 7
06 500, Mława

Radio remote control of the auxiliary heating

Digades GmbH Digitales Und Ana/Zittau
Äußere Weberstr. 20
02763 - Zittau, Germany
Phone: 0049 358357750

Instrument panel

Analogue SE38x/SE316
Visteon Electronics Germany GmbH
Visteonstr. 4-10
50170 Kerpen, Germany

Analogue all other models
Continental Automotive Spain, S.A.
Crta. de Rubí a Ullastrell, nº 12-30
08191 Rubí (Barcelona - Spain)

FPK (digital)

Continental Automotive GmbH
VDO-Strasse 1,
64832 Babenhausen, Germany

Panasonic Automotive Systems Europe GmbH
Robert Bosch Str. 27-29
63225 Langen, Germany

Panasonic Automotive Systems Czech, s.r.o.
U Panasonicu 266
530 06, Pardubice, Czech Republic

CUPRA Born Digital Cockpit
Europe - CE

LG Electronics Inc. Single Point of Contact
Krijgsman 1, 1186 DM Amstelveen,
The Netherlands

United Kingdom - UKCA
LG Electronics U.K. Ltd,
Velocity 2, Brooklands Drive,
Weybridge, KT13 OSL

Front radar sensors

MRR for SE38X
Robert Bosch GmbH
Markwiesenstrasse, 46
72770 Reutlingen (Kusterdingen) Germany

MRR for Tarraco, Ateca, Ibiza, Arona
Automotive Distance Control Systems GmbH
Peter-Dornier-Strasse, 10
88131, Lindau, Germany

Rear radar sensors

Hella GmbH & Co. KGaA
Rixbecker Straße 75
59552 Lippstadt (Germany)

Online Connectivity Unit

LG ELECTRONICS INC.
10, Magokjungang 10-ro,
Gangseo-gu, Seoul, Republic of Korea

Radio equipment, frequency band, maximum transmitting power

Below can be found details of the radio equipment¹⁾ that can be fitted to all SEAT models. Unless otherwise stated, the data are valid for all models (variations are indicated in footnotes to the tables):

Frequency band	Max. station power
Key with radio-operated remote control (vehicle)	
433.05-434.78 MHz	10 mW [ERP]
433.05-434.79 MHz	10 mW
868.0-868.6 MHz	25 mW
434.42 MHz	32 µW

Radio-operated remote control (auxiliary heater)

868.7-869.2 MHz (869.0 MHz)	25 mW
-----------------------------	-------

✓ Valid for: Leon, Ateca, Tarraco

Transmitter-Receiver (auxiliary heater)

868.7-869.2 MHz (869.0 MHz)	23.5 mW
-----------------------------	---------

✓ Valid for: Leon, Ateca, Tarraco

Bluetooth

2402-2480 MHz	6 dBm
---------------	-------

2400-2483.5 MHz	10 dBm
-----------------	--------

Connection to the vehicle's external antenna

GSM 900: 880-915 MHz	33 dBm
----------------------	--------

GSM 1800: 1710-1785 MHz	30 dBm
-------------------------	--------

WCDMA FDD I: 1920-1980 MHz	24 dBm
----------------------------	--------

WCDMA FDD III: 1710-1785 MHz	21 dBm
------------------------------	--------

WCDMA FDD VIII: 880-915 MHz	21 dBm
-----------------------------	--------

LTE FDD1: 1920-1980 MHz	23 dBm
-------------------------	--------

LTE FDD3: 1710-1785 MHz	23 dBm
-------------------------	--------

LTE FDD7: 2500-2570 MHz	23 dBm
-------------------------	--------

LTE FDD8: 880-915 MHz	23 dBm
-----------------------	--------

LTE FFD20: 832-862 MHz	23 dBm
------------------------	--------

✓ Valid for: Tarraco, Leon

Wireless hotspot

2400-2483.5 MHz	10 dBm
-----------------	--------

✓ Valid for: Leon, Ateca, Tarraco

Keyless Access

434.42 MHz	32 µW
------------	-------

125 kHz	89 dBµA/m ^{a1}
---------	-------------------------

^{a1} Valid for market: Ukraine

¹⁾ The commissioning or authorisation of radioelectrical technology may be restricted in some European countries, forbidden or only allowed with additional requirements.

Radar sensors for front assist systems

76 GHz-77 GHz	28.2 dBm ^{a)}
	35.0 dBm ^{b)}

^{a)} Valid for: Leon

^{b)} Valid for: Ibiza, Arona, Ateca, Tarraco

Radar sensors for rear assist systems

24050-24250 MHz	20 dBm
-----------------	--------

Wireless charging function

110-120 kHz	5 W
-------------	-----

Instrument cluster

125 kHz	40 dB μ A/m
---------	-----------------

Online Connectivity Unit

EGSM900: 880-915 MHz	33 dBm
DCS1800: 1710-1785 MHz	31 dBm
UMTS FDD 1: 1920-1980 MHz	24 dBm
UMTS FDD 3: 1710-1785 MHz	24 dBm
UMTS FDD 8: 880-915 MHz	24 dBm
E-UTRA FDD 1: 1920-1980 MHz	23.5 dBm
E-UTRA FDD 3: 1710-1785 MHz	23.0 dBm
E-UTRA FDD 7: 2500-2570 MHz	23.5 dBm
E-UTRA FDD 8: 880-915 MHz	23.0 dBm
E-UTRA FDD 20: 832-862 MHz	23.5 dBm
E-UTRA FDD 28: 703-748 MHz	23.0 dBm

Certificate: RLVHERS17-0286. RS4 Hella KGaA Hueck & Co. short-range radar IFT:RLVHERS17-0286. The operation of this equipment is subject to the following two conditions: (1) this equipment or device may not cause harmful interference, and (2) this equipment or device must accept any interference, including interference that may cause undesired operation.

United Kingdom

The following applies to importers in the UK market:

Volkswagen Group United Kingdom Ltd.
Yeomans Drive, Blakelands
Milton Keynes, MK 14 5AN
United Kingdom

Turkey

Telsiz Ekipmanları Yönetmeliği (2014/53/AB)

Aracınızda çeşitli telsiz ekipmanları bulunmaktadır.

Telsiz Ekipmanları Yönetmeliği (2014/53/AB) açısından Türkiye pazarı için radyo ekipmanı ithalatçısı (bu bilgi sadece resmi temsilcimiz olan Doğu Otomotiv Servis ve Ticaret A.Ş.'nin ithal ettiği ürünler için geçerlidir):

Doğu Otomotiv Servis ve Ticaret A.Ş.
Şekerpınar Mahallesi, Anadolu Caddesi, No: 22
ve 45
41420 Çayırova/Kocaeli

Additional information for countries outside the European Union**Mexico**

Your vehicle has different radioelectrical devices. The manufacturers of these devices declare that they comply with Directive RLVCOAR15-0008 when legally required. The full text of the declaration of conformity is available online at the following Internet address:

<https://www.seat.mx/servicio/mi-seat/manual-del-propietario.html>

Ukraine

Імпортёр:

ТОВ «Порше Україна»
просп. Павла Тичини, 1В, офіс „В“, 4-й
поверх
02152 Київ, Україна.

Importer:

Porsche Ukraine LLC
Pavla Tychny ave. 1V, Office "B", 4th floor
02152 Kyiv, Ukraine.

Technical data

Indications about the technical data

Vehicle identification data

The values indicated in the technical data may differ depending on optional equipment or version of the model, as well as in the case of special vehicles and equipment for certain countries.

The information in the official vehicle documentation takes precedence at all times.

Abbreviations used in the Technical Specifications section

kW	Kilowatt, engine power measurement.
PS	Horsepower (not currently used), engine power measurement unit.
rpm, 1/min	Revolutions per minute – engine speed.
Nm	Newton metres, unit of engine torque.
CZ	Cetane number, indication of the diesel combustion power.
RON	Research octane number, indication of the knock resistance of petrol.

Vehicle Identification Number (VIN)

The vehicle ID number can be found in the following places:

- Front, visible through the small window on the lower left side of the windscreen.
- One the vehicle's data label.
- To the right in the engine compartment.

Type plate

The type plate is located on the vehicle's right hand door frame. Vehicles for certain export countries do not have a type plate.

Performance

The values apply only to optimal road and weather conditions.

The vehicle's performance has been calculated without any equipment that would affect it, e.g. accessories.

Fuel consumption

Approved consumption values are derived from measurements performed or supervised by certified EU laboratories, according to the legislation in force at the time (for more information, see the Publications Office of the European Union on the EUR-Lex website: © European Union, <http://eur-lex.europa.eu/>) and apply to the specified vehicle characteristics.

The values relating to fuel consumption and CO₂ emissions can be found in the documentation provided to the purchaser of the vehicle at the time of purchase.

Fuel consumption and CO₂ emissions depend on the equipment/features of each individual vehicle, as well as on the driving style, road conditions, traffic conditions, environmental conditions, load or number of passengers.

Tank level

Rigid axle front wheel drive vehicles	45 l, 7 l reserve
Multi-link axle front-wheel drive vehicles	50 l, 7 l reserve
Vehicles with all-wheel drive	55 l, 8.5 l reserve
Plug-in hybrid vehicles (PHEV)	40 l, 8 l reserve

Adblue® tank volume

approx. 12 l^{a)}

approx. 13 l^{a)}

^{a)} The amount filled using a dispenser nozzle may be less. In conditions of extreme cold, the amount filled may be less. The values depend on the equipment.

High-voltage battery

Type and capacity

Plug-in hybrid vehicles (PHEV)	Li-ion 12.8 kWh 48V
--------------------------------	---------------------

Weights

The kerb weight values apply to the vehicle as ready to drive with a driver (75 kg), operating fluids and, if applicable, tools and the spare wheel. The kerb weight increases with optional equipment and retrofitting of accessories, which reduces the possible payload accordingly.

Load on the roof

The maximum authorised load on the roof of your vehicle is 50 kg (Leon) and 75 kg (Leon Sportstourer).

Trailer weight

The maximum permitted drawbar load on the ball head of the towing bracket is **80 kg**.

WARNING

The values indicated for the maximum permitted weights must not be exceeded. There is a risk of accident and damage!

Engine specifications

Petrol engines	1.0 EcoTSI Start-Stop		1.0 EcoTSI Start-Stop MHEV		1.4 Start-Stop
	Leon	LEON Sportstourer	Leon	LEON Sportstourer	Leon
Power output in kW (hp) at 1/min	81 (110)/5,500		81 (110)/5,500		110 (150)/5,000-6,000
Maximum torque (Nm at 1/min)	200/2,000-3,000		200/2,000-3,000		250/1,500-3,500
No. of cylinders/displacement (cm ³)	3/999		3/999		4/1,395
Fuel	Super 95 / Normal 91 (with a slight power loss) ROZ				
Gearbox	manual	manual	DSG	DSG	DSG
Top speed (km/h)	197 (V)	199 (V)	192 (VI)	199 (VI)	214 (VI)
Acceleration from 0-100 km/h (s)	10.8	11.2	10.6	11.0	8.5
Maximum authorised weight (kg)	1,750	1,900	1,850	1,940	1,840

Technical data

Petrol engine	1.4 TSI Start-Stop PHEV	
	Leon	LEON Sportstourer
TSI engine power in kW (hp) at 1/min	110 (150)/5,000-6,000	
Electric motor power in kW (hp) at 1/min	85 (116)/2,600-6,500	
TSI engine + electric motor power in kW (hp) at 1/min	150 (204)/5,000-6,000	
TSI engine maximum torque (Nm at 1/min)	250/1,550-3,500	
Electric motor maximum torque (Nm at 1/min)	330/0-2,600	
Maximum torque of TSI engine + electric motor (Nm at 1/min)	350/0-3,500	
No. of cylinders/displacement (cm ³)	4/1,395	
Fuel	Super 95 / Normal 91 (with a slight power loss) ROZ	
Gearbox	DSG	
Top speed (km/h)	220 (V)	220 (V)
Acceleration from 0-100 km/h (s)	7.5	7.7
Maximum authorised weight (kg)	2,050	2,070

Indications about the technical data

Petrol engines	1.5 Start-Stop ACT®		1.5 Start-Stop ACT®		1.5 Start-Stop ACT® MHEV	
	Leon	LEON Sports-tourer	Leon	LEON Sports-tourer	Leon	LEON Sports-tourer
Power output in kW (hp) at 1/min	96 (130)/5,000-6,000		110 (150)/5,000-6,000		110 (150)/5,000-6,000	
Maximum torque (Nm at 1/min)	200/1,400-4,000		250/1,500-3,500		250/1,500-3,500	
No. of cylinders/displacement (cm ³)	4/1,498		4/1,498		4/1,498	
Fuel	Super 95 / Normal 91 (with a slight power loss) ROZ					
Gearbox	manual	manual	manual	manual	DSG	DSG
Top speed (km/h)	208 (V)	209 (V)	217 (V)	218 (V)	217 (VI)	218 (VI)
Acceleration from 0-100 km/h (s)	9.4	9.7	8.7	9.0	8.5	8.8
Maximum authorised weight (kg)	1,850	1,950	1,860	1,950	1,890	1,980

Petrol engines	1.6 MPI	
	Leon	LEON Sportstourer
Power output in kW (hp) at 1/min	81 (110)/5,800	81 (110)/5,800
Maximum torque (Nm at 1/min)	152/3,850-4,100	152/3,850-4,100
No. of cylinders/displacement (cm ³)	4/1,598	4/1,598
Fuel	Super 95 / Normal 91 (with a slight power loss) ROZ	
Gearbox	DSG	DSG
Top speed (km/h)	190 (V)	190 (V)
Acceleration from 0-100 km/h (s)	12.1	12.5
Maximum authorised weight (kg)	1,780	1,860

Technical data

Diesel engines	2.0 TDI Start-Stop		2.0 TDI CR 2.0	
	Leon	LEON Sportstourer	Leon	LEON Sportstourer
Power output in kW (hp) at 1/min	85 (116)/2,750-4,250		110 (150)/3,000-4,200	
Maximum torque (Nm at 1/min)	300/1,600-2,500		340/1,600-3,000	
No. of cylinders/displacement (cm ³)	4/1,968		4/1,968	
Fuel	EN 590 standard diesel, min. 51 CZ			
Gearbox	manual	manual	manual	manual
Top speed (km/h)	200 (V)	200 (V)	215 (V)	217 (V)
Acceleration from 0-100 km/h (s)	10.2	10.6	8.9	9.2
Maximum authorised weight (kg)	1,940	2,020	1,950	2,030

Diesel engines	2.0 TDI Start-Stop		
	Leon	LEON Sportstourer	
Power output in kW (hp) at 1/min	110 (150)/3,000-4,200		
Maximum torque (Nm at 1/min)	360/1,600-2,750		
No. of cylinders/displacement (cm ³)	4/1,968		
Fuel	EN 590 standard diesel, min. 51 CZ		
Gearbox	DSG	DSG	DSG 4Drive
Top speed (km/h)	215 (VI)	217 (VI)	214 (VI)
Acceleration from 0-100 km/h (s)	8.5	8.8	8.4
Maximum authorised weight (kg)	1,970	2,070	2,150

Dimensions.

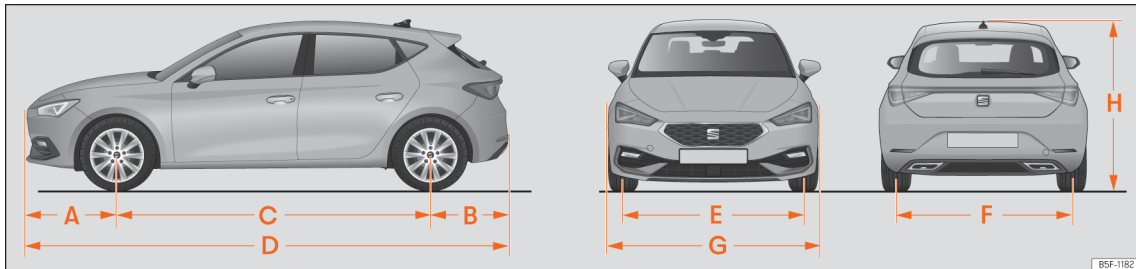


Fig. 255 Leon

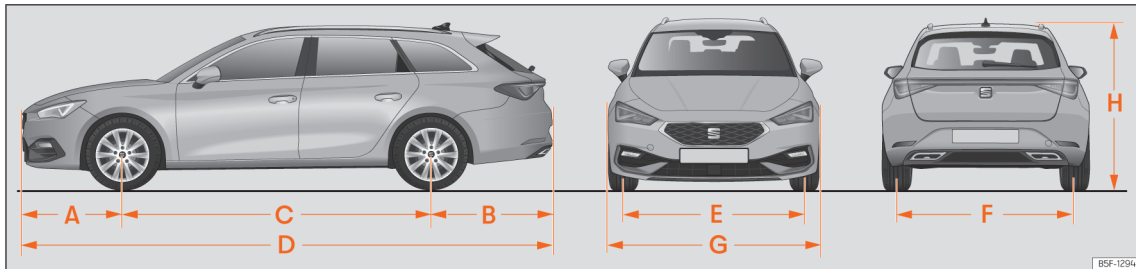


Fig. 256 LEON Sportstourer

Technical data

»» Fig. 255 , »» Fig. 256		Leon	LEON Sportstourer
A/B	Front and rear projection (mm)	888/794	888/1,068
C	Wheelbase (mm)	2,686	2,686
D	Length (mm)	4,368	4,642
E/F	Front/rear ^{a)} track width (mm)	1,550/1,520	1,550/1,520
G	Width (mm)	1,799	1,799
H	Height at kerb weight (mm)	1,456	1,450
	Turning radius (m)	11.2	11.2

^{a)} This data will change depending on the type of wheel rim. Values for wheel 195/65 R15 ET43.

Index

Numbers and Symbols

4Drive	150
12-volt battery	337
assisted start	315
charge level	343
charging	339
control lamps	341
disconnect and connect	339
electrolyte level	339
energy management	343
replacement	339
48-volt battery	342
control lamps	343

A

ACC	185
Accessories	370
Activating SEAT CONNECT	239
Adapting the playback volume	257
Adaptive Cruise Control	185
control and warning lamp	190
malfunction	190
operation	186
special driving situations	188
status display	186
System limitations	189
AdBlue®	
control and warning lamps	310
information	308
loading	309
minimum filling capacity	308

specification	309
tank capacity	308
Adjust	
front seats	111
headrest	114
lights	123
seat with memory	116
seats	42
time and date	30
Adjusting the seat belt	48
Air conditioning	132
air recirculation	136
controls	134
parking ventilation	139
troubleshooting	140
Air recirculation	136
Airbag system	51
activation	53
control lamp	53
deactivation of the front airbag	55
description	52
front airbags	54
how it works	53
Airbags	51
activating and deactivating	55
centre	56
description	52
for the head	58
for the knees	59
front	54
side	56
Android Auto™	
disconnecting	247
establish connection	247
menu	246
requirements	246
special characteristics	247
Anti-lock system	173
Anti-puncture	359
Anti-puncture kit	359
check after 10 minutes	361
components	360
inflating the tyre	360
sealing the tyre	360
Anti-puncture set	359
Anti-theft alarm	96
interior monitoring and anti-tow system	96
trailer	296
Anti-theft alarm system	96
Anti-trap function	
sunroof	108
windows	106
Antifreeze	328
Apple CarPlay	
disconnecting	246
establish connection	246
menu	245
requirements	245
special characteristics	246
Applications (apps)	245
Approved spare parts	364
Aspects to think about before starting the vehicle	41
Assistance systems	
adaptive cruise control	185
Auto-Hold function	210
connecting	177
cruise control	181
driver alert system	27
driving assist (Travel Assist)	199
Emergency Assist	203

- emergency braking (Front Assist) 193
 front camera 179
 front radar 178
 general notes 177
 lane departure warning (Side Assist) 205
 parking aid Plus 213
 PreCrash system 50
 predictive speed adjustment 191
 rear camera 181
 rear parking aid 216
 rear radar 179
 road signs detection system 28
 safety advice 177
 speed limiter 183
 switching off 177
 system limits 177
 tyre pressure monitor indicator 357
 tyre pressure monitoring 358
 ultrasound sensors 180
 Assisted start 315
 Audible warning
 lights 119
 unbuckled seat belt 45
 Audio warning signals
 warning and control lamps 13
 Auto Lock (central locking) 92
 Auto Unlock 92
 Auto-Hold 210
 Auto-Hold function 210
 Automatic car wash 365
 disconnecting the Auto-Hold function 210
 Automatic dipped beam headlight control 118
 Automatic gearbox
 control lamp 163
 downhill assistant 168
 driving tips 165
 launch-control program 166
 selector lever positions 163
 steering wheel with shift paddles 165
 tiptronic 165
 Auxiliary heating
 activate 143
 connecting 141
 electricity consumers 143
 programming 143
 radio-operated remote control 140, 141
 special characteristics 143
 switching off 141
 usage instructions 143
 Average fuel consumption 18
- B**
- Background lighting 125
 Backrest of the rear seat
 folding 112
 raise 112
 Bag hooks 232, 290
 Battery 89
 Before starting the vehicle 41
 Belt force limiter 49
 Belt tightening 49
 Bicycle carrier
 fitting onto the coverable tow hook 302
 max. load rating 302
 Biodiesel 308
 Blown bulbs
 change a bulb 324
 Bonnet
 opening and closing 327
 Brake fluid 332
 Brakes 172
 brake fluid 332
 brake servo 172
 braking assistant 173
 electronic parking brake 209
 new brake pads 172
 Braking assistant 173
 Braking system
 warning lamp 173
 Brands 258
- C**
- Camera
 cleaning the vehicle 29
 Catalytic converter 311
 Central armrests 117
 Central locking 92
 anti-theft alarm 96
 auto-locking due to involuntary opening 92
 central locking button 94
 emergency lock 98
 Keyless Access system 90
 remote control key 93
 Cetane index (diesel fuel) 308
 Change a bulb 324
 Change the wiper blades 313
 Changing a wheel 351
 raise the vehicle 355
 subsequent work 357
 wheel nuts 354
 Changing parts 370
 Changing the battery
 of the vehicle key 89
 Charging cable
 for charging stations (AC) 84
 for sockets 84

- Charging socket 77
- Charging the high-voltage battery
 - charging cable 84
 - charging modes 76
 - charging process display 79
 - emergency unlocking 80
 - Infotainment system settings 81
 - programmed charging 82
 - socket (AC) 77
 - troubleshooting 80
- Check lists
 - requirements for Android Auto™ 246
 - requirements for Apple CarPlay 245
 - requirements for MirrorLink® 247
 - reverse assist (Rear View) 224
- Child lock
 - electric windows 104
- Child seats
 - attachment systems 62
 - group classification 60
 - i-Size 63
 - ISOFIX 63
 - safety instructions 61
 - securing with the seat belt 67
 - Top Tether system 66
- Cleaning
 - high pressure cleaning equipment 365
 - special care 368
 - vehicle exterior 366
 - vehicle interior 367
 - washing the vehicle 365
- Climate control
 - rear controls 136
 - setting the temperature 136
 - stationary air conditioning 144
- Clocks
 - set the time 30
- Closing 92
 - bonnet 327
 - rear lid 100
 - sunroof 107
 - windows 104
- Clutch (lamp) 168
- Coming Home 122
- Connectivity
 - WLAN access point 242
- Control and warning lamps
 - 12-volt battery 341
 - ACC 190
 - adaptive cruise control 186
 - AdBlue® 310
 - air conditioning 140
 - airbag system 53
 - airbags 55
 - anti-lock brake system ABS 175
 - automatic gearbox 163
 - braking system 173
 - cruise control 183
 - cruise control (GRA) 181
 - drive system 158
 - E-MODE operating mode 159
 - electromechanical steering 169
 - emissions control 312
 - engine coolant 22
 - engine management 312
 - engine oil 337
 - ESC 175
 - ESC in Sport mode 175
 - ESC off 175
 - fuel reserve 21
 - high-voltage battery 80
 - high-voltage system 80
 - Lane Assist 198, 199
 - lane departure warning (Side Assist) 206
 - lights 118
 - parking brake 210
 - particulate filter 311, 312
 - press on the brake 185
 - refuelling 21, 306
 - remote control (independent heating) .. 140, 141
 - seat belt 45
 - speed limiter 184
 - Start-Stop 159
 - steering column 169
 - TCS 175
 - tow hook 301
 - tyre pressure monitor system 358
- Control lamps
 - overview 13
- Controls on the steering wheel 109
 - Convenience close function
 - sunroof 107
 - Convenience open function
 - sunroof 107
- Cooling 132
- Cooling system
 - check the coolant 330
 - refilling coolant 330
- Copyright 258
- Cornering light 119
- Correct position 42
 - driver 42
 - passenger 43
- Cruise control 181

- Cruise control system 181
 control lamps 183
 operating 182
 Current documentation attached 250
- D**
- Dangers of not using the seat belt 46
 Data label 381
 Data transfer 237
 Deactivating SEAT CONNECT services 241
 Deactivation of the front airbag 55
 Diesel
 refuelling 308
 Disposal
 seat belt tensioners 50
 Door cylinder 98
 Door handle 98
 Door lock 98
 Door opening assist (Exit Warning) 228
 Doors 97
 child lock 99
 Downhill assistance function 168
 downhill assistant 168
 Download
 over-the-air updates 236
 Drawers 231
 Drink holder
 bottle holder 231
 front 231
 in the rear central armrest 231
 Drive system
 control lamps 158
 Driver alert system 27
 Driving
 driving on flooded roads 150
 economical 147
 loaded vehicle 149
 safe 41
 trips abroad 123, 151
 with the luggage compartment open 149
 with trailer 299
 Driving Assist (Travel Assist)
 see Travel Assist 199
 Driving data 25
 Driving data indicator 25
 Driving mode 171
 Driving on flooded roads 150
 Driving profile 171
 Driving with a loaded vehicle 149
 Driving with the luggage compartment open 149
 DSG 163
 Duplicate keys 87
 Dust and pollen filter 132
 Dynamic headlight range control 123
- E**
- e-Call 70
 E-Mode 158
 E-MODE operating mode
 control lamps 159
 E10
 see Ethanol (fuel) 308
 Easy Open
 special characteristics 102
 Eco-driving notes 184
 Electric devices 232
 Electric windows 104
 Electrolyte 339
 Electronic differential lock 173
 Electronic immobilizer 155
 Electronic parking brake 209
 control lamps 210
 Electronic Stability Control (ESC) 173
 Emergencies 70
 anti-puncture kit 359
 changing a wheel 351
 changing the battery 339
 emergency vehicle towing 317
 hazard warning lights 69
 jump leads 315
 replace a blown fuse 322
 vehicle tool kit 313
 Emergency Assist 203
 connecting and disconnecting 204
 problems and solutions 204
 see Emergency Assist 203
 status display 204
 Emergency braking assist system 178
 activating and deactivating 196
 dodge assist 194
 pedestrian and cyclist recognition 194
 status display 193
 system limitations 195
 temporarily deactivating 197
 turn assist 195
 warnings 193
 Emergency braking warning 69
 Emergency call 70
 Emergency call service 70
 Emergency locking of the front passenger door
 98
 Emergency opening
 driver's door 98
 rear lid 103
 Emergency operation
 front passenger door 98

- Emissions control system
 - AdBlue® 308
 - catalytic converter 311
 - control lamp 312
 - particulate filter 311
 - Energy management 343
 - Engine
 - noise 153
 - running in 150
 - start (driver instructions with the mechanical contact) 156
 - Start-Stop system 159
 - Engine and ignition
 - emergency start 156
 - preheat the engine 153
 - starting the engine 153
 - starting the engine with Press & Drive 153
 - switching off the engine 154
 - Engine compartment
 - battery 337
 - engine oil 335
 - opening and closing 327
 - safety instructions 325
 - Engine coolant 328
 - check the level 330
 - exterior 24
 - specifications 328
 - tank (hybrid vehicles) 330
 - temperature indicator 22
 - warning lamp 22
 - Engine failure
 - control lamp 312
 - Engine management 310
 - control lamp 312
 - Engine oil
 - change 334, 336
 - check the oil level 335
 - consumption 335
 - dipstick 335
 - inspection service 334
 - maintenance frequencies 334
 - refill 335
 - specifications 334
 - Engine oil pressure
 - control lamp 337
 - Engine specifications 383
 - Environment
 - ecological driving 147
 - environmental compatibility 373
 - recycling of electrical appliances 374
 - refuelling 305
 - Environmental tip
 - refuelling 305
 - ESC
 - connecting and disconnecting 175
 - electronic stability control (ESC) 173
 - Sport mode 175
 - Ethanol (fuel) 308
 - Event Data Recorder 372
 - Exhaust gases 310
 - Exit Warning 228
 - Exiting a parking space
 - with the parking assist system 223
 - Exterior lighting
 - change a bulb 324
 - Exterior mirrors
 - driving with a trailer 295
 - folding 130
 - heated 130
 - settings 130
 - External antenna 370
 - External audio sources
 - adapting the playback volume 257
- ## F
- Fabrics: clean 367
 - Factors that have a negative influence on safe driving 41
 - Fastening rings 289
 - Filling capacities
 - AdBlue® tank 308
 - window washer water 333
 - Filling the tank 306
 - Fire 70
 - Four-wheel drive 150
 - Frequency bands 263
 - Front bonnet 325
 - Front camera 179
 - Front compartment
 - brake fluid 332
 - coolant 328, 330
 - windscreen washer reservoir 333
 - Front passenger front airbag
 - control lamp 53
 - Fuel
 - diesel 308
 - ethanol 308
 - fuel gauge 21
 - identification 307
 - petrol 307
 - refuelling 306
 - saving 147
 - Fuel consumption
 - inertia disconnection 147
 - why does consumption increase? 312

- Fuel gauge 21
 control lamp 21
- Fuel tank cap
 opening and closing 306
- Fuel tank flap
 opening and closing 306
- Full Link 244
 applications 245
 settings 245
 symbols 245
- Full-LED headlights 324
- Fuses 321
 colour coded 322
 fuse box 321, 322
 preparations for replacing fuses 322
 recognise blown fuses 322
 replace 322
- G**
- Gear change
 manual gearbox 162
- Gear indication 147
- Gear-change recommendation 147
- Glass roof sun blind 108
- Glove compartment 230
- H**
- Hangers 232
- Hazard warning lights 69
- Head-on collisions and the laws of physics 46
- Headlight range control 123
- Headlights
 change a bulb 324
 trips abroad 123
- Headrest 113
 adjust 114
 removing 115
- Heating 132
- High-voltage battery
 care 75
 safety instructions 73
 warning lettering 74
- High-voltage battery charging cable 82
- Hybrid drive
 battery level indicator 21
 E-Mode 158
 Hybrid mode 158
 operating modes 158
 switching on the drive system 156
 system power indicator 23
 vehicle sound 157
- I**
- i-Size 63
- Identification of fuels 307
- Inertia mode 167
- Infotainment 250
 adapt menus 256
 Android Auto™ 246
 Apple CarPlay 245
 assistants and vehicle settings 38
 before first use 250
 clean 258
 connecting and disconnecting 256
 customise 256
 customised menus 256
 departure menu 40
 drop-down menu 256
 executing functions 256
 function buttons 35
- help 33
 initial configuration 36
 Internet access 243
 Media mode 266
 MirrorLink® 247
 navigation 269
 operating 256
 overview and controls 253, 254
 Radio mode 262
 safety instructions 250
 share a WLAN connection 243
 sound settings 257
 system settings 257
 technical data 258
 telephone interface 276
 tutorial 33
 vehicle information 37
 Wi-Fi Protected Setup (WPS) 243
 WLAN 243
- Infotainment system
 see Infotainment 33
- Inspection 334, 362
- Inspection reminder 31
- Inspection service 334
- Installing software
 over-the-air updates 236
- Instrument panel 15, 17
 digital [SEAT Digital Cockpit] 18
 display 17
 service intervals display 31
 status display 23
 symbols 13
 time and date 30
 use with the multifunction steering wheel 33
 warning and control lamps 13
 warning and information messages 26

Instrument panel display	18, 23
Hybrid vehicles	19
Instrument panel lighting	123
Interior mirror	
anti-dazzle	129
Interior monitoring and the anti-tow system	
activation	96
ISOFIX	63
ISOFIX system	63

J

Jack	313
position points	355
Jump leads	315
Jump start	315
description	315
jump leads	315

K

Key switch	55
Keyless Access	
Press & Drive	152
starting the engine	153
troubleshooting	91
unlocking and locking the vehicle	90
Keys	
changing the battery	89
instructions for the driver (mechanical contact)	
.....	156
pull out the key blade	88
remote control	87
spare key	87
synchronise	89
unlock and lock	93, 98
vehicle key	87

L

Lane Assist	197
control and warning lamp	198
control lamps	199
Lane Assist system	197
Lane change assist	201
Lane departure warning (Side Assist)	
control lamp	206
driving situations	207
how it works	205
lane change Plus	206
light indication	206
system limitations	205
Launch-control (automatic transmission)	166
Leaving Home	122
Legal provisions	240
Licenses	258
Lift the vehicle	355
Light Assist	121
Lights	
audible warnings	119
AUTO	118
background lighting	125
change a bulb	324
coming home	122
control and warning lamps	118
control lighting	123
control panel	118
cornering light	119
daytime running lights	119
dipped beam headlights	118
fog light	118
headlight range control	123
instrument lighting	123
interior lights	124
leaving home	122

main beam assist	121
main beam headlight lever	120
main beam headlights	118
reading lights	124
side lights	118
switching on and off	118
turn signal lever	120
Loading the luggage compartment	
fastening rings	289
general advice	282
luggage compartment	282
positioning the load	282
positioning the luggage	282
roof carrier system	293
trailer	298
trapdoor for transporting long objects	291
Lock and unlock	90
in the locking cylinder	98
with the central locking button	94
Luggage compartment	100, 282
electric opening and closing	100
emergency unlocking	103
enlarge	112
features of the electric rear lid	101
luggage compartment lighting	124
net bag	289
net partition	287, 288
opening and closing controlled by sensors (Easy Open)	102
removing and fitting the shelf	283
retractable shelf	284
store the rear shelf	284
storing the rear shelf	285
variable luggage compartment floor	286
Luggage compartment floor	286

- Luggage compartment shelf
storing 285
- Luggage net
luggage compartment 289
- Lumbar support 111
- M**
- Main beam assist 121
- Main beam headlight lever 120
- Maintenance frequencies 334
- Malfunction
adaptive cruise control 190
clutch 168
PreCrash system 51
sunroof 106
towing device 296
- Manual gearbox 162
- Mats 147
- Media Mode 266
equipment 267
symbols 267
- Memory function 116
- Microfiber: clean 367
- MirrorLink®
disconnecting 248
establish connection 247
menu 247
requirements 247
settings 245
special characteristics 248
- Mirrors 128
adjusting the exterior mirrors 130
anti-dazzle 129
- Mobile phones 370
- Mobility Service 364
- Multimedia 248, 262
favourites 267
play 267
select source 267
- N**
- Navigation 269, 272
decrease the navigation map 270
edit route 274
enter an address for a guide destination 272
favourite destinations 273
frequent destinations 273
function: entering destination 272
functions 271
increase the navigation map 270
last destinations 273
learn usage pattern 275
limitations 269
navigation announcements 269
operating the navigation map 270
route details 274
save destination 273
saved data 270
saved destinations 273
symbols 271
traffic reports 274
updating navigation data 272
use contact details 274
- Net bag
luggage compartment 289
- Net partition 287, 288
- Noise
auxiliary heating 143
brakes 172
- parking brake 209
tyres 345
- Number of seats 43
- O**
- Octane (petrol) 307
- Odometer 17, 18
partial 24
total 24
- Oil change 336
- On-board toolkit 313
- One-touch signalling function 120
- Online services 237
- Opening 92
bonnet 327
rear lid 100
sunroof 107
tank cap 306
windows 104
- Opening and closing 92
bonnet 327
by remote control 93
doors 97
in the locking cylinder 98
rear lid 100
rear lid with electric opening and closing 100
sunroof 107
sunshade blind 108
tank cap 306
windows 104
with the central locking button 94
- Operation in winter
diesel 308
salt on the roads 128
snow chains 350
tyres 350

- Original accessories 364
- Over-the-air updates 235
- download 236
- installing software 236
- requirements 236
- Overview
- of warning and control lamps 13
- overview (left hand drive) 11
- overview (right hand drive) 12
- view of the vehicle from inside 10
- view of the vehicle from the front 6, 7
- view of the vehicle from the rear 8, 9
- Ownership accreditation 239
- P**
- Painting the vehicle
- care 366
- Park assist
- fault 213
- operating 215
- parking aid plus 213
- rear parking aid 216
- see the Parking assist system 217
- sensors and camera: clean 366
- surroundings warning 213
- visual indication 216
- Parking 208
- at an angle with the reverse assist 226
- automatic gearbox 165
- with the parking assist system 222
- Parking assist system 217
- angle parking 222
- description 219
- leaving a parking space (only when parallel parked) 223
- parallel parking 222
- parking conditions 222
- stop early 219
- Parking systems
- automatic brake operation 211
- reverse assist (Rear View Camera) 224
- troubleshooting 212
- Parking ventilation 139
- Partial odometer 31
- Particulate filter 311
- Pedals 43, 147
- Petrol
- additives 307
- particulate filter 311
- refuelling 307
- Places with risk of explosion 277
- Places with special regulations 277
- Power meter 23
- Power sockets 232
- trailer 296
- PreCrash system 50
- Front Assist monitoring system 50
- malfunction 51
- selecting the driving profile 51
- status display 51
- Predictive speed adjustment 191
- activation 192
- driving 192
- limitations 191
- troubleshooting 192
- Preheat the engine 153
- Press & Drive
- start button 152
- starting the engine 153
- Privacy 241
- settings 242
- R**
- Radar sensors 178
- Radio 262
- equipment 263
- frequency bands 263
- preset buttons 263
- symbols 263
- Traffic information (TP) 264
- tune station 263
- type of reception 263
- Radio mode 262
- Radio screen: clean 367
- Radio telephones 370
- Rain and light sensor 127
- Rain sensor
- function control 128
- Raise the vehicle 355
- Rear camera 181
- Rear Cross Traffic Alert 227
- Rear Cross Traffic Alert (RCTA) 227
- Rear fog light
- control lamp 118
- Rear lid 99, 103
- Rear mounting
- towing device 303
- Rear parking aid 216
- Rear radar 179
- Rear seat
- fold down with the remote unlocking lever ... 117
- Rear View Camera 224
- Rear window wiper 126
- Refuelling
- control lamp 21
- fuel gauge 21
- opening the fuel tank flap 306
- safety warnings 305

- Releasing the seat belt 47
- Remote control (independent heating) ... 140, 141
- Remote control key
unlock and lock 93
- Repair work 370
- Requirements for Apple CarPlay 245
- Retractable shelf 284
- Reverse assist 224
- Reverse assist (Rear View) 224
- angle parking 226
- check list 224
- connecting and disconnecting 225
- cross traffic 225
- requirements 224, 226
- settings 226
- shown on the display 225
- usage instructions 226
- Reverse assist system 224
- Revolution counter 17, 18, 20
- Road signs
shown on the display 28
- Road signs detection system 28
- how it works 28
- limited operation 29
- shown on the display 28
- speed warning 29
- windscreen damage 29
- Roof carrier 292
- fix the crossbars 292
- Roof carrier system 292
- Roof rack 292
- Rotation direction
tyres 357
- Running in
new brake pads 172
- new engine 150
- new tyres 345
- S**
- Safe 94, 155
- Safe driving 41
- Safe security system 94
- troubleshooting 95
- Safety
child safety 59
- child seats 59
- safe driving 41
- Safety equipment 41
- Safety instructions 250
- central airbag 56
- head-protection airbags 58
- seat belt tensioners 50
- side airbags 56
- using child seats 61
- using seat belts 45
- Save fuel
inertia mode 167
- Screen 17
- clean 258
- Seat belt tensioners 49
- control lamp 53
- Seat belts
adjusting the seat belt 48
- adjustment 47
- automatic retractor, tensioner and belt force limiter 49
- control lamp 45
- maintenance and disposal of seat belt tensioners 50
- protective function 44
- purpose 51
- safety instructions 45
- symbols 45
- unfastened 46
- SEAT CONNECT 237
- activation 239
- deactivate 241
- faults 241
- legal provisions 240
- SEAT Digital Cockpit 18
- SEAT Drive Profile 170
- SEAT Drive Profiles 170
- see Drive profile selection 170
- selecting a profile 170
- Seat heating 137
- SEAT Ident 239
- Seats 111
- adjusting the headrests 114
- armrest 117
- backrest of the rear seat 112
- electric settings 112
- fitting the headrest 115
- heating 137
- incorrect positions 43
- manual adjustment 111
- memory function 116
- number of seats 43
- removing the headrest 115
- Selection of driving profile
characteristics 170
- Selective catalytic reduction 308
- Selector lever (automatic transmission)
positions 163
- Selling the vehicle 240

Service			
Digital Maintenance plan	362		
inspection	362		
proof of Service	362		
service sets	364		
service works	362		
terms of use	363		
Service interval display	31		
Service intervals	31		
Service Menu			
service interval display	31		
vehicle identification number	31		
Service Mobility	364		
Set of vehicle keys	87		
Shift paddles (automatic transmission)	165		
Snow chains	350		
Sound settings	257		
Spare parts	370		
Spare wheel	352		
Special characteristics			
Android Auto™	247		
Apple CarPlay	246		
high pressure cleaning equipment	301		
MirrorLink®	248		
tow start	317		
towing	317		
trailer mode	299		
Speed limiter	183		
control lamps	184		
indication on display	183		
operating	184		
Speed symbol	345		
Stabilisation of the towing vehicle and trailer combination	300		
Start button	152		
Start the engine by towing	318		
special characteristics	317		
Start-Stop	159		
Start-Stop system			
disconnect and connect manually	162		
driver indications	162		
how it works	159		
lamps	159		
stopping and starting the engine	159		
the engine does not turn off	159		
the engine starts by itself	159		
Stationary air conditioning	144		
activate	145		
connecting	144		
programming	145		
switching off	144		
Status display			
adaptive cruise control	186		
doors, front bonnet and rear lid open	24		
Eco-driving notes	184		
Emergency Assist	204		
Emergency brake assistance system (Front Assist)	193		
instrument panel	23		
odometer	24		
outside temperature	24		
PreCrash system	51		
road signs	28		
SEAT Drive Profile	170		
selector lever positions	163		
service intervals	31		
speed limiter	183		
speed warning	24		
time and date	30		
Travel Assist	200		
tyre pressure monitoring	357		
warning and information messages	26		
Steering			
control lamp	169		
electromechanical steering	169		
steering assist	169		
Steering assist	169		
Steering wheel			
adjust	110		
controls	109		
heating	139		
shift paddles (automatic transmission)	165		
Steering wheel heating	139		
Storage compartment	230		
drawers	231		
glove compartment	230		
on-board documentation	230		
other object holders	232		
Storage compartment accessories			
see Storage	230		
Storage of accident data	372		
Storing objects	282		
bag hooks	290		
fastening rings	289		
loading the trailer	298		
net bag	289		
positioning the load	282		
positioning the luggage	282		
roof carrier	292		
roof carrier system	292, 293		
trailer	294		
trailer mode	299		
trapdoor for transporting long objects	291		
Sun blind	131		
Sun protection	131		

- Sunroof 106, 107
 anti-trap function 108
 convenience open/close function 107
 malfunction 106
 sunshade blind 108
- Switching off
 telephone 277
- Symbols
 see Warning and control lamps 13
- System settings 257
- T**
- Tail lights
 change a bulb 324
- Technical data
 engine specifications 383
 vehicle dimensions 387
 vertical load on the tow hitch 294
 weights 381
- Technical modifications 370
- Telephone
 connecting 277
 contacts 280
 favourites 280
 pairing a mobile phone 277
 phone book 280
 send messages 279
 speed dial buttons 280
 switching off 277
 to call 279
- Telephone interface 276
 equipment 276
 places with risk of explosion 277
 symbols 276
- Time
 adjust 30
- Tiptronic (automatic transmission) 165
- Top Tether 66
- Top Tether System 66
- Torque
 wheel nuts 356
- Touch screen 253, 254
- Touch zones 253
- Tow cable 295, 296
- Tow hook
 control lamp 301
 unlocking electrically 301
- Towable loads
 loading the trailer 298
- Towing device
 fitting a bicycle carrier 302
 fitting later 303
 malfunction 296
 tow hook with electric unlocking 301
- Towing the vehicle
 emergency towing 319
 front towline anchorage 319
 prior steps 319
 rear towline anchorage 320
 special characteristics 317
 tow bar 317
 tow cable 317
 towing prohibited 318
- Traction control 173
- Traffic information 274
- Traffic information (TP) 264
- Traffic programme
 see TP (traffic information) 264
- Trailer 294
 adjusting the headlights 299
 anti-theft alarm 296
 connecting 296
- exterior mirrors 295
 hitching 296
 LED tail lights 295, 296
 loading 298
 malfunction 296
 power socket 296
 retrofitting a towing bracket 303
 stabilisation of the towing vehicle and trailer
 combination 300
 tail lights 295, 296
 technical requirements 295
 tow cable 295, 296
 towable loads 298
 trailer mode 299
 unlocking the tow hook electrically 301
 vertical load on the tow hitch 294, 298
- Trailer mode
 see Trailer 294
- Transportation of children 59
- Trapdoor for transporting long objects 291
- Travel Assist 199
 connecting and disconnecting 201
 lane change assist 201
 problems and solutions 203
 status display 200
- Trips abroad 151
 headlights 123
- Troubleshooting
 AdBlue® 310
 DSG gearbox 168
 Emergency Assist 204
 Start-Stop system 162
 Travel Assist 203
- Turn signal lever 120
- Turning off the lights 118
- Turning on the lights 118

- Tyre pressure 347
 Tyre pressure monitor system 358
 Tyre pressure monitor systems
 tyre pressure monitor indicator 357
 Tyre profile 348
 Tyre repair 359
 Tyre repair kit 359
 Tyre tread depth 348
 Tyre wear 348
 Tyres 345
 accessories 345
 change 351
 directional tread pattern 345, 357
 for winter 350
 foreign objects inserted 345
 new tyres 346
 snow chains 350
 speed symbol 345
 tread wear indicators 348
 tyre pressure 347
 useful life 347
- U**
- Ultrasound sensors 180
 Unlock and lock 90
 by remote control 93
 doors 97
 with the central locking button 94
 USB 248
 USB port 248
- V**
- Vanity mirror 131
 Variable luggage compartment floor 286
- Vehicle
 data label 381
 engine specifications 383
 identification data 381
 interior view 10
 lending or selling 240
 overview (left hand drive) 11
 overview (right hand drive) 12
 raise 355
 unlocking and locking (Keyless Access) 90
 vehicle ID number 381
 view from behind 8, 9
 view from the front 6, 7
 Vehicle care
 wiper blade service position 313
 Vehicle conservation 365
 Vehicle conservation products 365
 Vehicle dimensions 387
 Vehicle information 37
 Vehicle location 240
 Vehicle seats 43
 Vehicle settings 38
 Vehicle sound 157
 Vehicle tool kit 313
 Ventilation 132
 Vertical load on the tow hitch 294
 loading the trailer 298
 Voice control 260
 Android Auto™ 247
 end 261
 start 261
 Siri™ (Apple CarPlay™) 246
 wake word: 261
 Volume
 set for external audio sources 257
- W**
- Warning lamps
 overview 13
 Warning triangle 69
 Warranty 372
 Washing the vehicle
 cleaning the exterior 366
 high pressure cleaning equipment 365
 interior cleaning 367
 special care 368
 special characteristics 102
 Weights 381
 Wheel balance 347
 Wheel nuts 349
 anti-theft device 354
 caps 353
 loosen 354
 torque 356
 Wheel spanner 313
 Wheel trim 353
 Wheels
 change 351
 changing 348
 new wheels 346
 removing and attaching 356
 snow chains 350
 spare wheel 352
 wheel nuts 349
 wheel trim 353
 Window controls 104
 Window washer
 window washer lever 126
 Window washer system 333

Window washer water	
check	333
filling quantities	333
refill	333
Windows	104
anti-trap function	106
automatic opening/closing	105
automatic operation	105
Windscreen washer	126
Windscreen wipers	126
functions	127
lift the blade	313
rain and light sensor	127
reposition the blade	313
service position	313
special characteristics	126
Winter conditions	
sunroof	106
trailer	294
Winter tyres	350
Wiper and rear window wiper blades	
cleaning the vehicle	314, 366
replacement	314
service position	313
WLAN	242

SEAT S.A. is permanently concerned about continuous development of its types and models. For this reason we ask you to understand, that at any given time, changes regarding shape, equipment and technique may take place on the car delivered. For this reason no right at all may derive based on the data, drawings and descriptions in this current handbook.

All texts, illustrations and standards in this handbook are based on the status of information at the time of printing. Except for error or omission, the information included in the current handbook is valid as of the date of closing print.

Re-printing, copying or translating, whether total or partial is not allowed unless SEAT allows it in written form.

SEAT reserves all rights in accordance with the "Copyright" Act.

All rights on changes are reserved.

 This paper has been manufactured using bleached non-chlorine cellulose.

© SEAT S.A. - Reprint: 15.01.24

Inglés 5FA012720CK (01.24)



5FA012720CK

